

## Features

- Ultra High Efficiency (Up to 96.0%)
- Full Power at Wide Output Current Range (Constant Power)
- Adjustable Output Current (AOC) with Programmability
- Isolated 0-10V/PWM/3-Timer-Modes Dimmable
- INV Digital Dimming, UART Based Communication Protocol
- Dim-to-Off with Standby Power
- Minimum Dimming Level with 5% or 10% Selectable
- Maximum Dimming Level with 9V or 10V Selectable
- Fade Time Adjustable
- Always-on Auxiliary Power: 12Vdc, 250mA
- Low inrush current
- Output Lumen Compensation
- End-of-Life Indicator
- Input Surge Protection: DM 6kV, CM 10kV
- All-Around Protection: IUVP, IOVP, OVP, SCP, OTP
- IP66 / IP67 and UL Dry / Damp / Wet Location
- TYPE HL, for use in a Class I, Division 2 hazardous (Classified) location
- 5 Years Warranty



## Description

The ESM-680SxxxMx series is a 680W, constant-current, programmable and IP66/IP67 rated LED driver that operates from 249-528Vac input with excellent power factor. Created for many lighting applications including high mast, sports, UV-LED, aquaculture and horticulture, etc. It provides an auxiliary voltage and dim-to-off functionality for powering low voltage, wireless controls. The dimming control supports 0-10V dimming as well as two-way communication via Digital Dimming, a UART based communication protocol. The high efficiency of these drivers and compact metal case enables them to run cooler, significantly improving reliability and extending product life. To ensure trouble-free operation, protection is provided against input surge, input under voltage, input over voltage, output over voltage, short circuit, and over temperature.

## Models

Adjustable Output Current Range	Full-Power Current Range(1)	Default Output Current	Input Voltage Range(2)	Output Voltage Range	Max. Output Power	Typical Efficiency (3)	Typical Power Factor		Model Number
							277Vac	480Vac	
0.125-1.7A	1.25-1.7A	1.7 A	249~528Vac 352~500Vdc	200 ~ 544Vdc	680 W	96.0%	0.99	0.96	ESM-680S170Mx
0.18-2.4A	1.8-2.4A	2.1 A	249~528Vac 352~500Vdc	141.5 ~ 378Vdc	680 W	95.5%	0.99	0.96	ESM-680S240Mx
0.26-3.5A	2.6-3.5A	3.5 A	249~528Vac 352~500Vdc	97.1 ~ 262Vdc	680 W	95.5%	0.99	0.96	ESM-680S350Mx
0.42-5.6A	4.2-5.6A	5.6 A	249~528Vac 352~500Vdc	60.7 ~ 163Vdc	680 W	95.5%	0.99	0.96	ESM-680S560Mx
0.63-8.4A	6.3-8.4A	8.4 A	249~528Vac 352~500Vdc	40.4 ~ 108Vdc	680 W	95.5%	0.99	0.96	ESM-680S840Mx <sup>(4)</sup>
1.26-15.0A	12.6-15.0A	15.0 A	249~528Vac 352~500Vdc	22.6 ~ 54Vdc	680 W	94.5%	0.99	0.96	ESM-680S15AMx <sup>(4)</sup>

**Notes:** (1) Output current range with constant power at 680W.

(2) Certified voltage range: 277-480Vac

(3) Measured at 100% load and 480Vac input (see below "General Specifications" for details).

(4) SELV output

(5) x = G are UL Recognized and ENEC, etc. models; x = T are UL Class P models.

## I-V Operating Area

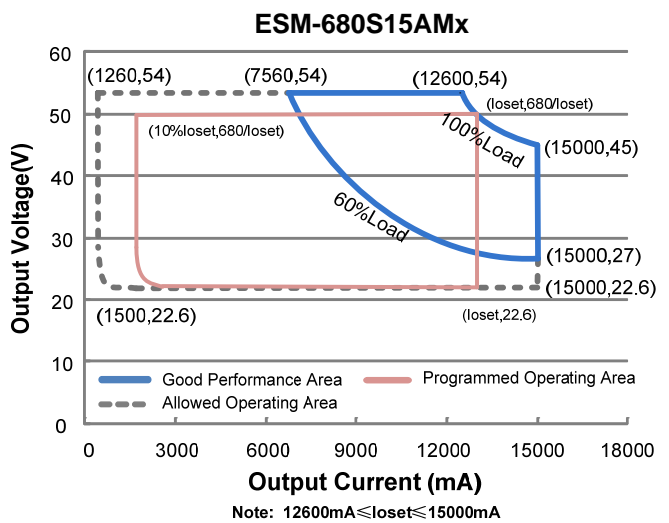
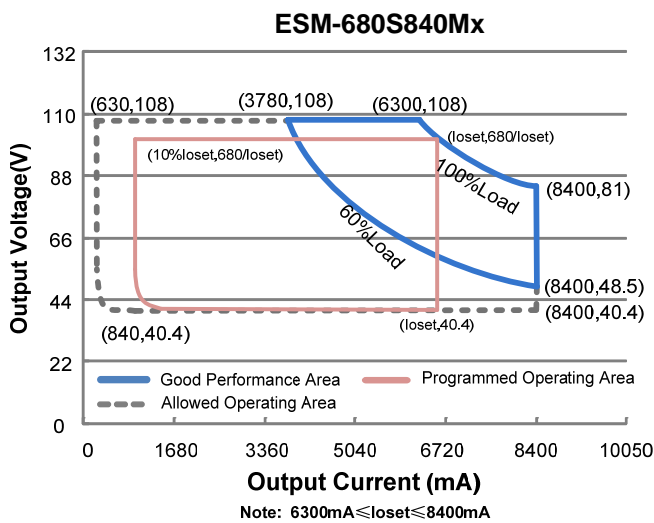
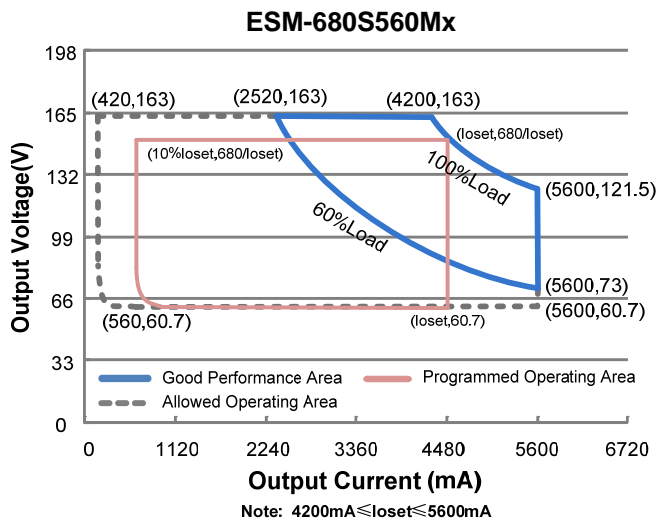
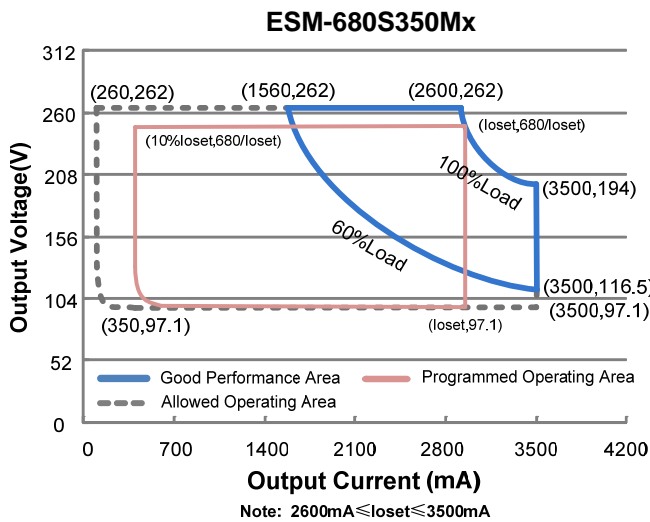
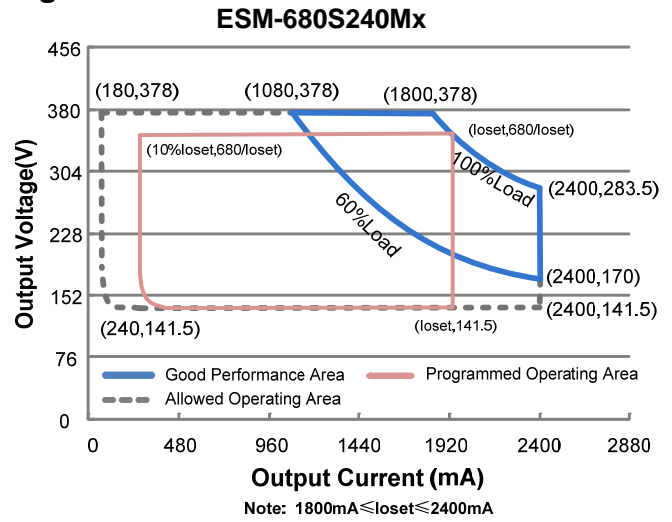
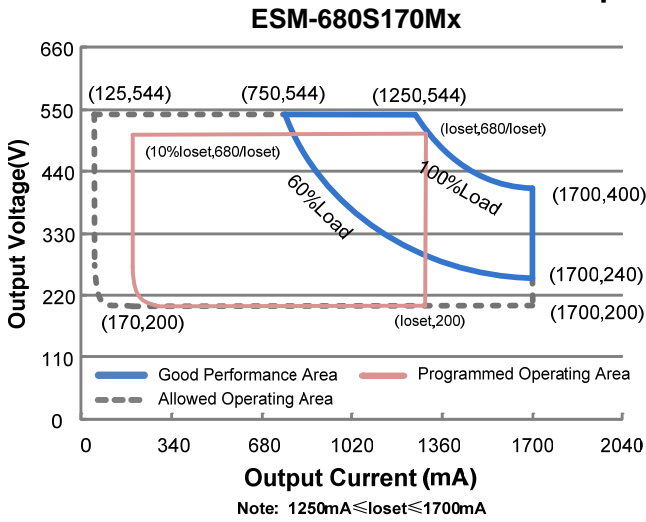

## Input Specifications

Parameter	Min.	Typ.	Max.	Notes
Input AC Voltage	249 Vac	-	528 Vac	
Input AC Voltage	352 Vdc	-	500 Vdc	
Input Frequency	47 Hz	-	63 Hz	
Leakage Current	-	-	0.75 MIU	UL8750; 480Vac/ 60Hz
			0.70 mA	IEC60598-1; 480Vac/ 60Hz
Input AC Current	-	-	2.95 A	Measured at 100% load and 277 Vac input.
	-	-	1.72 A	Measured at 100% load and 480 Vac input.
Inrush Current(I <sup>2</sup> t)	-	-	1.55 A <sup>2</sup> s	At 480Vac input, 25°C cold start, duration=6.56 ms, 10%Ipk-10%Ipk. See Inrush Current Waveform for the details.
PF	0.90	-	-	At 277-480Vac, 50-60Hz, 60%-100% Load (408 - 680W)
THD	-	-	20%	

## Output Specifications

Parameter	Min.	Typ.	Max.	Notes
Output Current Tolerance	-5%loset	-	5%loset	100% load
Output Current Setting(loset) Range				
ESM-680S170Mx	125 mA	-	1700 mA	
ESM-680S240Mx	180 mA	-	2400 mA	
ESM-680S350Mx	260 mA	-	3500 mA	
ESM-680S560Mx	420 mA	-	5600 mA	
ESM-680S840Mx	630 mA	-	8400 mA	
ESM-680S15AMx	1260 mA	-	15000 mA	
Output Current Setting Range with Constant Power				
ESM-680S170Mx	1250 mA	-	1700 mA	
ESM-680S240Mx	1800 mA	-	2400 mA	
ESM-680S350Mx	2600 mA	-	3500 mA	
ESM-680S560Mx	4200 mA	-	5600 mA	
ESM-680S840Mx	6300 mA	-	8400 mA	
ESM-680S15AMx	12600 mA	-	15000 mA	
Total Output Current Ripple (pk-pk)	-	5%Iomax	10%Iomax	100% load, 20 MHz BW
Output Current Ripple at < 200 Hz (pk-pk)	-	-	2%Iomax	70%-100% load
Startup Overshoot Current	-	-	10%Iomax	100% load
No Load Output Voltage				
ESM-680S170Mx	-	-	600 V	
ESM-680S240Mx	-	-	420 V	
ESM-680S350Mx	-	-	300 V	
ESM-680S560Mx	-	-	220 V	
ESM-680S840Mx	-	-	120 V	
ESM-680S15AMx	-	-	60 V	
Line Regulation	-	-	±0.5%	100% load
Load Regulation	-	-	±3.0%	

## Output Specifications (Continued)

Parameter	Min.	Typ.	Max.	Notes
Turn-on Delay Time	-	-	0.5 s	Measured at 277-480Vac input, 60%-100% Load
Temperature Coefficient of I <sub>o</sub> set	-	0.03%/°C	-	Case temperature = 0°C ~T <sub>c</sub> max
12V Auxiliary Output Voltage	10.8 V	12 V	13.2 V	
12V Auxiliary Output Source Current	0 mA	-	250 mA	Return terminal is "Dim"
12V Auxiliary Output Transient Peak Current@6W	-	-	500 mA	500mA peak for a maximum duration of 2.2 ms in a 6.0ms period during which time the average should not exceed 250mA.
12V Auxiliary Output Transient Peak Current@10W	-	-	850 mA	850mA peak for a maximum duration of 1.3 ms in a 5.2ms period during which time the average should not exceed 250mA.

## General Specifications

Parameter	Min.	Typ.	Max.	Notes
Efficiency at 277 Vac input:				Measured at 100% load and steady-state temperature in 25°C ambient; (Efficiency will be about 2.0% lower if measured immediately after startup.)
ESM-680S170Mx				
I <sub>o</sub> = 1250 mA	92.5%	94.5%	-	
I <sub>o</sub> = 1700 mA	92.0%	94.0%	-	
ESM-680S240Mx				
I <sub>o</sub> = 1800 mA	92.0%	94.0%	-	
I <sub>o</sub> = 2400 mA	91.5%	93.5%	-	
ESM-680S350Mx				
I <sub>o</sub> = 2600 mA	92.5%	94.5%	-	
I <sub>o</sub> = 3500 mA	92.0%	94.0%	-	
ESM-680S560Mx				
I <sub>o</sub> = 4200 mA	92.0%	94.0%	-	
I <sub>o</sub> = 5600 mA	91.5%	93.5%	-	
ESM-680S840Mx				
I <sub>o</sub> = 6300 mA	92.0%	94.0%	-	
I <sub>o</sub> = 8400 mA	91.0%	93.0%	-	
ESM-680S15AMx				
I <sub>o</sub> = 12600 mA	91.5%	93.5%	-	
I <sub>o</sub> = 15000 mA	91.5%	93.5%	-	
Efficiency at 400 Vac input:				Measured at 100% load and steady-state temperature in 25°C ambient; (Efficiency will be about 2.0% lower if measured immediately after startup.)
ESM-680S170Mx				
I <sub>o</sub> = 1250 mA	93.5%	95.5%	-	
I <sub>o</sub> = 1700 mA	92.5%	94.5%	-	
ESM-680S240Mx				
I <sub>o</sub> = 1800 mA	93.0%	95.0%	-	
I <sub>o</sub> = 2400 mA	92.0%	94.0%	-	
ESM-680S350Mx				
I <sub>o</sub> = 2600 mA	93.5%	95.5%	-	
I <sub>o</sub> = 3500 mA	92.5%	94.5%	-	
ESM-680S560Mx				
I <sub>o</sub> = 4200 mA	93.0%	95.0%	-	
I <sub>o</sub> = 5600 mA	92.5%	94.5%	-	
ESM-680S840Mx				
I <sub>o</sub> = 6300 mA	93.0%	95.0%	-	
I <sub>o</sub> = 8400 mA	92.0%	94.0%	-	
ESM-680S15AMx				
I <sub>o</sub> = 12600 mA	92.0%	94.0%	-	
I <sub>o</sub> = 15000 mA	92.5%	94.5%	-	

## General Specifications (Continued)

Parameter	Min.	Typ.	Max.	Notes	
Efficiency at 480 Vac input: ESM-680S170Mx I <sub>o</sub> = 1250 mA I <sub>o</sub> = 1700 mA	94.0% 93.0%	96.0% 95.0%	- -	Measured at 100% load and steady-state temperature in 25°C ambient; (Efficiency will be about 2.0% lower if measured immediately after startup.)	
ESM-680S240Mx I <sub>o</sub> = 1800 mA I <sub>o</sub> = 2400 mA	93.5% 92.5%	95.5% 94.5%	- -		
ESM-680S350Mx I <sub>o</sub> = 2600 mA I <sub>o</sub> = 3500 mA	93.5% 93.0%	95.5% 95.0%	- -		
ESM-680S560Mx I <sub>o</sub> = 4200 mA I <sub>o</sub> = 5600 mA	93.5% 92.5%	95.5% 94.5%	- -		
ESM-680S840Mx I <sub>o</sub> = 6300 mA I <sub>o</sub> = 8400 mA	93.5% 92.5%	95.5% 94.5%	- -		
ESM-680S15AMx I <sub>o</sub> = 12600 mA I <sub>o</sub> = 15000 mA	92.5% 92.5%	94.5% 94.5%	- -		
Standby Power	-	1.5 W	-		Measured at 480Vac/50Hz; Dimming off
MTBF	-	200,000 Hours	-		Measured at 480Vac input, 80%Load and 25°C ambient temperature (MIL-HDBK-217F)
Lifetime	-	102,000 Hours	-		Measured at 480Vac input, 80%Load and 70°C case temperature; See lifetime vs. T <sub>c</sub> curve for the details
	-	65,000 Hours	-		Measured at 277Vac input, 100%Load and 40°C ambient temperature
Operating Case Temperature for Safety T <sub>c_s</sub>	-40°C	-	+90°C		
Operating Case Temperature for Warranty T <sub>c_w</sub>	-40°C	-	+80°C	Case temperature for 5 years warranty Humidity: 10% RH to 95% RH;	
Storage Temperature	-40°C	-	+85°C	Humidity: 5%RH to 95%RH	
Dimensions Inches (L × W × H) Millimeters (L × W × H)	9.85 × 5.32 × 1.82 250 × 135 × 46			With mounting ear 10.83 × 5.32 × 1.82 275 × 135 × 46	
Net Weight	-	3060 g	-		

## Dimming Specifications

Parameter	Min.	Typ.	Max.	Notes
Absolute Maximum Voltage on the V <sub>dim</sub> (+) Pin	-20 V	-	20 V	
Source Current on V <sub>dim</sub> (+)Pin	200 uA	300 uA	450 uA	V <sub>dim</sub> (+) = 0 V

## Dimming Specifications (Continued)

Parameter		Min.	Typ.	Max.	Notes
Dimming Output Range with 10%-100% (Default)	ESM-680S170Mx ESM-680S240Mx ESM-680S350Mx ESM-680S560Mx ESM-680S840Mx ESM-680S15AMx	10%loset	-	loset	1250 mA ≤ loset ≤ 1700 mA 1800 mA ≤ loset ≤ 2400 mA 2600 mA ≤ loset ≤ 3500 mA 4200 mA ≤ loset ≤ 5600 mA 6300 mA ≤ loset ≤ 8400 mA 12600 mA ≤ loset ≤ 15000 mA
	ESM-680S170Mx ESM-680S240Mx ESM-680S350Mx ESM-680S560Mx ESM-680S840Mx ESM-680S15AMx	125 mA 180 mA 260 mA 420 mA 630 mA 1260 mA	-	loset	125 mA ≤ loset < 1250 mA 180 mA ≤ loset < 1800 mA 260 mA ≤ loset < 2600 mA 420 mA ≤ loset < 4200 mA 630 mA ≤ loset < 6300 mA 1260 mA ≤ loset < 12600 mA
Dimming Output Range with 5%-100% (Settable)	ESM-680S170Mx ESM-680S240Mx ESM-680S350Mx ESM-680S560Mx ESM-680S840Mx ESM-680S15AMx	5%loset	-	loset	1250 mA ≤ loset ≤ 1700 mA 1800 mA ≤ loset ≤ 2400 mA 2600 mA ≤ loset ≤ 3500 mA 4200 mA ≤ loset ≤ 5600 mA 6300 mA ≤ loset ≤ 8400 mA 12600 mA ≤ loset ≤ 15000 mA
	ESM-680S170Mx ESM-680S240Mx ESM-680S350Mx ESM-680S560Mx ESM-680S840Mx ESM-680S15AMx	63 mA 90 mA 130 mA 210 mA 315 mA 630 mA	-	loset	125 mA ≤ loset < 1250 mA 180 mA ≤ loset < 1800 mA 260 mA ≤ loset < 2600 mA 420 mA ≤ loset < 4200 mA 630 mA ≤ loset < 6300 mA 1260 mA ≤ loset < 12600 mA
Recommended Dimming Input Range		0 V	-	10 V	Default 0-10V dimming mode.
Dim off Voltage		0.35 V	0.5 V	0.65 V	
Dim on Voltage		0.55 V	0.7 V	0.85 V	
Hysteresis		-	0.2 V	-	
PWM_in High Level		3 V	-	10 V	Dimming mode set to PWM in PC interface.
PWM_in Low Level		-0.3 V	-	0.6 V	
PWM_in Frequency Range		200 Hz	-	3 KHz	
PWM_in Duty Cycle		1%	-	99%	
PWM Dimming off (Positive Logic)		3%	5%	8%	
PWM Dimming on (Positive Logic)		5%	7%	10%	
PWM Dimming off ( Negative Logic)		92%	95%	97%	
PWM Dimming on ( Negative Logic)		90%	93%	95%	
Hysteresis		-	2%	-	

## Safety & EMC Compliance

Safety Category	Standard
UL/CUL	UL8750,CAN/CSA-C22.2 No. 250.13
ENEC & CE	EN 61347-1, EN 61347-2-13



## Safety & EMC Compliance (Continued)

Safety Category	Standard
CB	IEC 61347-1, IEC 61347-2-13
EMI Standards	Notes
EN 55015 <sup>(1)</sup>	Conducted emission Test & Radiated emission Test
EN 61000-3-2	Harmonic current emissions
EN 61000-3-3	Voltage fluctuations & flicker
FCC Part 15 <sup>(1)</sup>	ANSI C63.4 Class B
	This device complies with Part 15 of the FCC Rules. Operation is subject to the following two conditions: [1] this device may not cause harmful interference, and [2] this device must accept any interference received, including interference that may cause undesired Operation.
EMS Standards	Notes
EN 61000-4-2	Electrostatic Discharge (ESD): 8 kV air discharge, 4 kV contact discharge
EN 61000-4-3	Radio-Frequency Electromagnetic Field Susceptibility Test-RS
EN 61000-4-4	Electrical Fast Transient / Burst-EFT
EN 61000-4-5	Surge Immunity Test: AC Power Line: Differential Mode 6 kV, Common Mode 10 kV
EN 61000-4-6	Conducted Radio Frequency Disturbances Test-CS
EN 61000-4-8	Power Frequency Magnetic Field Test
EN 61000-4-11	Voltage Dips
EN 61547	Electromagnetic Immunity Requirements Applies To Lighting Equipment

**Note:** (1) This LED driver meets the EMI specifications above, but EMI performance of a luminaire that contains it depends also on the other devices connected to the driver and on the fixture itself.

## Lifetime vs. Case Temperature

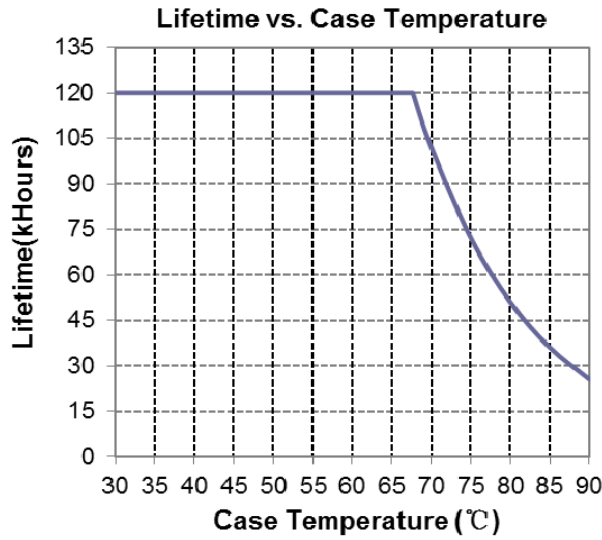

## Inrush Current Waveform

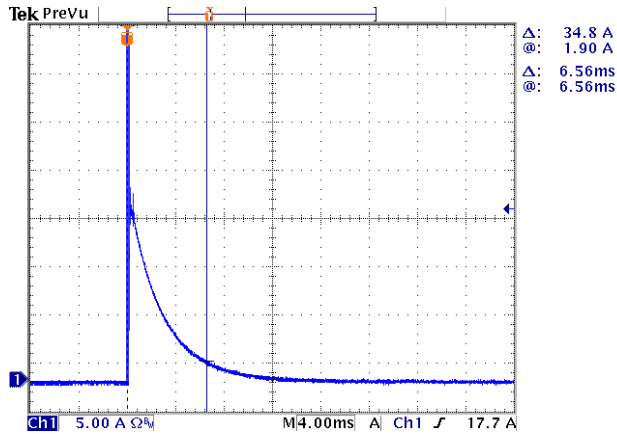

## Efficiency vs. Load

ESM-680S170Mx( $I_o=1250mA$ )  
Efficiency vs. Output Voltage

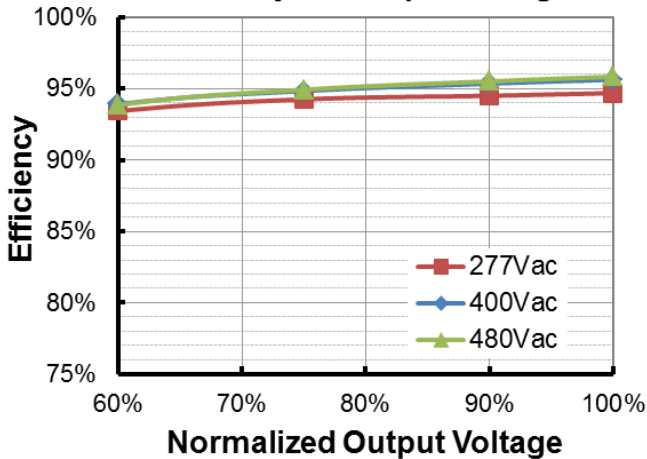

ESM-680S170Mx( $I_o=1700mA$ )  
Efficiency vs. Output Voltage

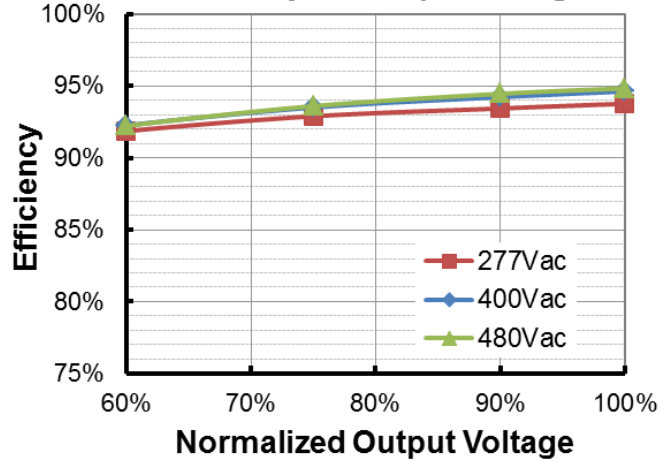



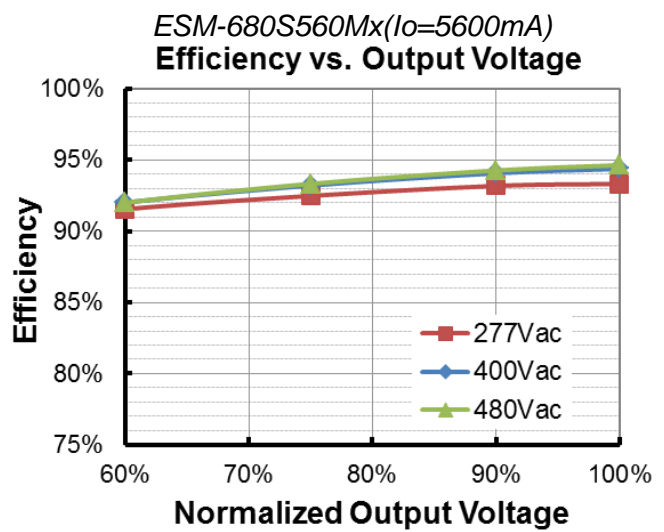
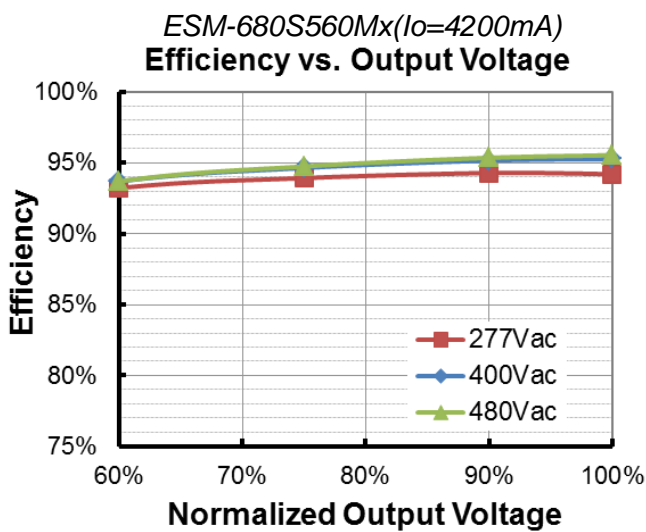
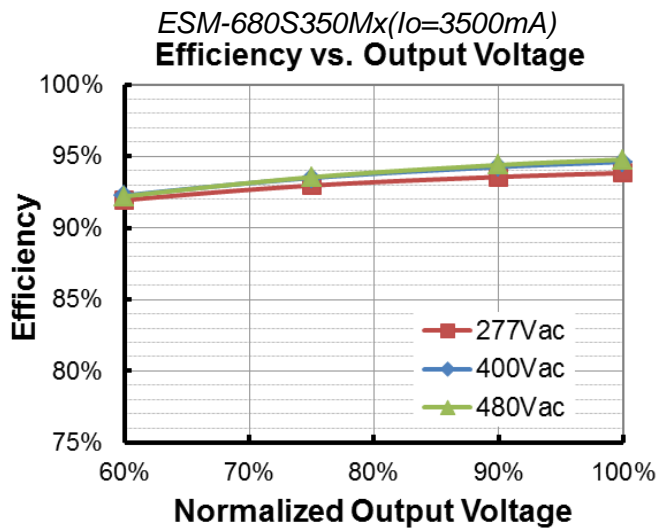
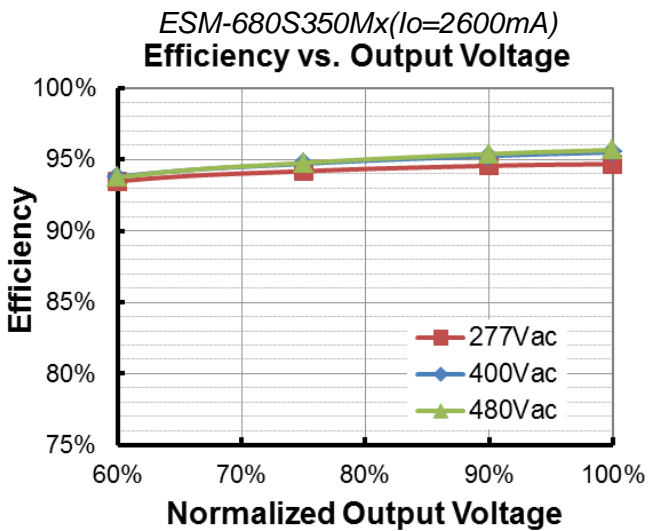
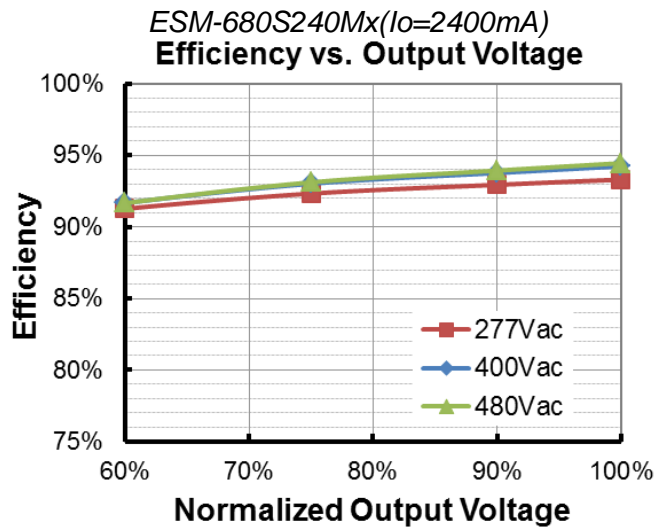
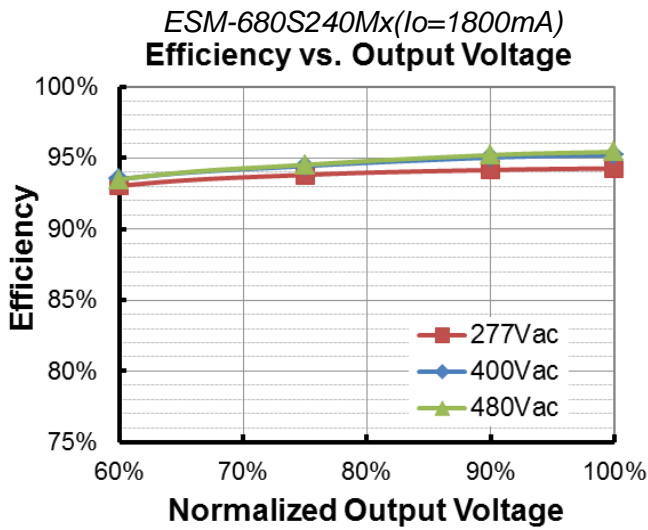

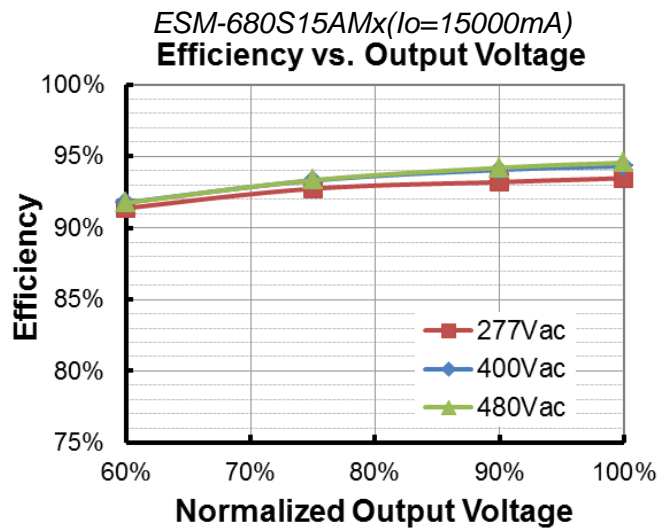
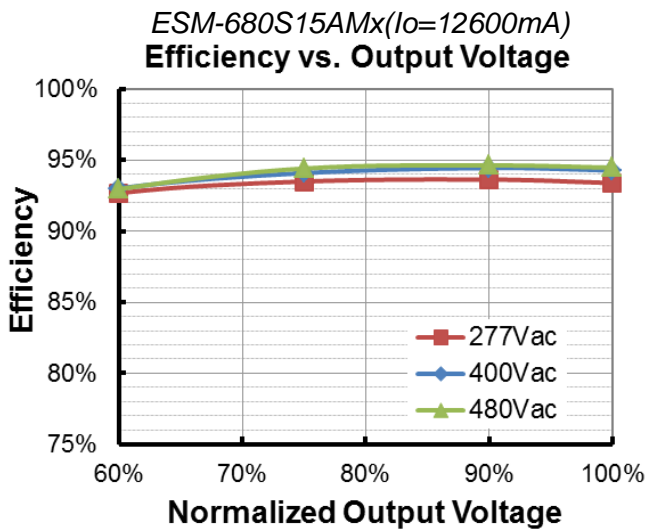
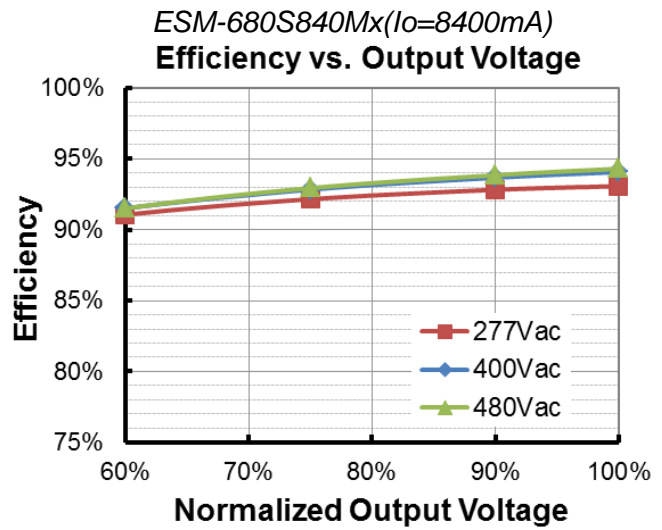
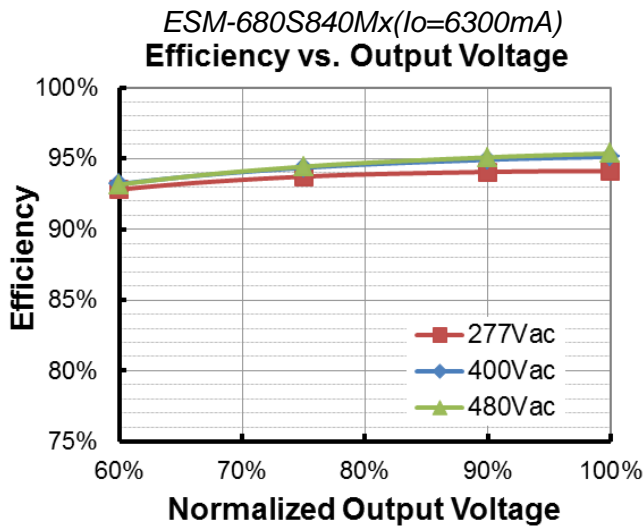

## Power Factor

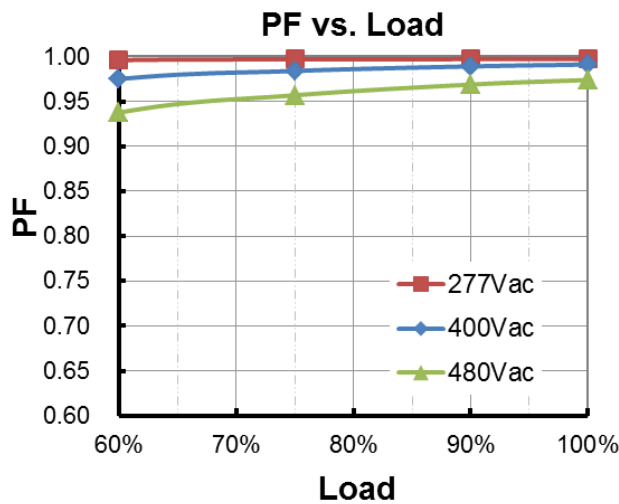

## Total Harmonic Distortion

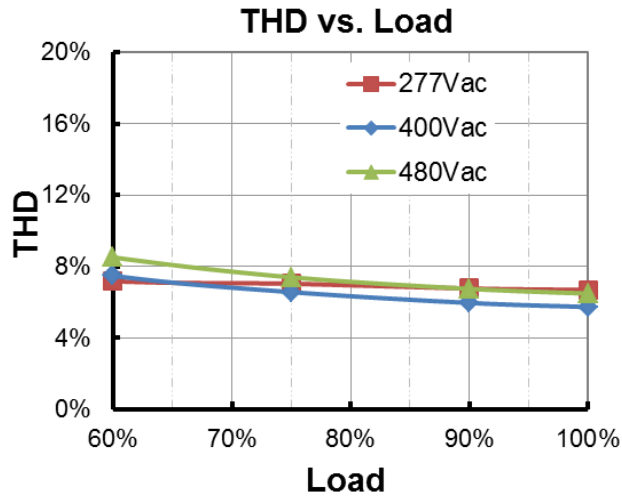

## Protection Functions

Parameter		Min.	Typ.	Max.	Notes
Over Temperature Protection		Decreases output current, returning to normal after over temperature is removed.			
Short Circuit Protection		Auto Recovery. No damage will occur when any output is short circuited. The output shall return to normal when the fault condition is removed.			
Over Voltage Protection		Limits output voltage at no load and in case the normal voltage limit fails.			
Input Under Voltage Protection (IUVP)	Input Protection Voltage	220 Vac	230 Vac	240 Vac	Turn off the output when the input voltage falls below protection voltage.
	Input Recovery Voltage	230 Vac	240 Vac	250 Vac	Auto Recovery. The driver will restart when the input voltage exceeds recovery voltage.
Input Over Voltage Protection (IOVP)	Input Over Voltage Protection	550 Vac	570 Vac	590 Vac	Turn off the output when the input voltage exceeds protection voltage.
	Input Over Voltage Recovery	530 Vac	550 Vac	570 Vac	Auto Recovery. The driver will restart when the input voltage falls below recovery voltage.
	Max. of Input Over Voltage			590 Vac	The driver can survive for 8 hours with a stable input voltage stress of 590Vac.

### ● Input Under Voltage Protection Diagram

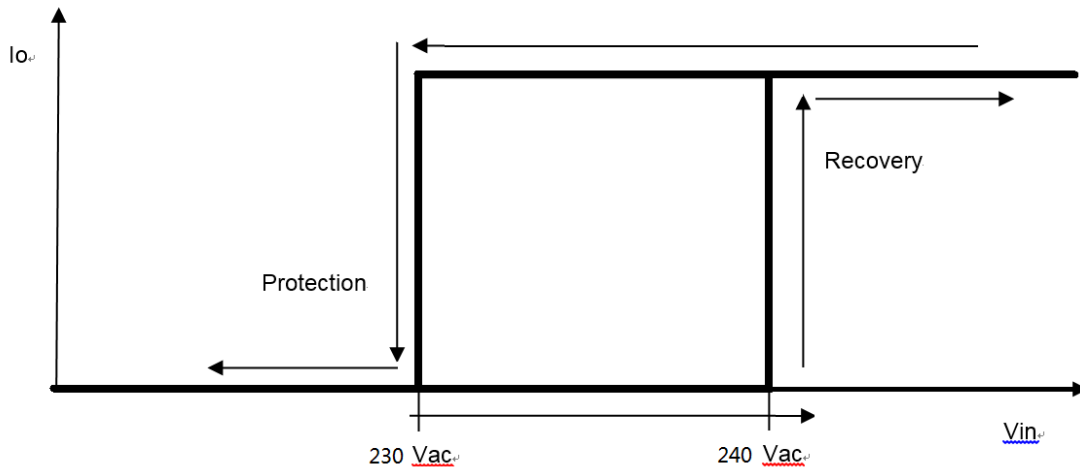

● **Input Over Voltage Protection Diagram**

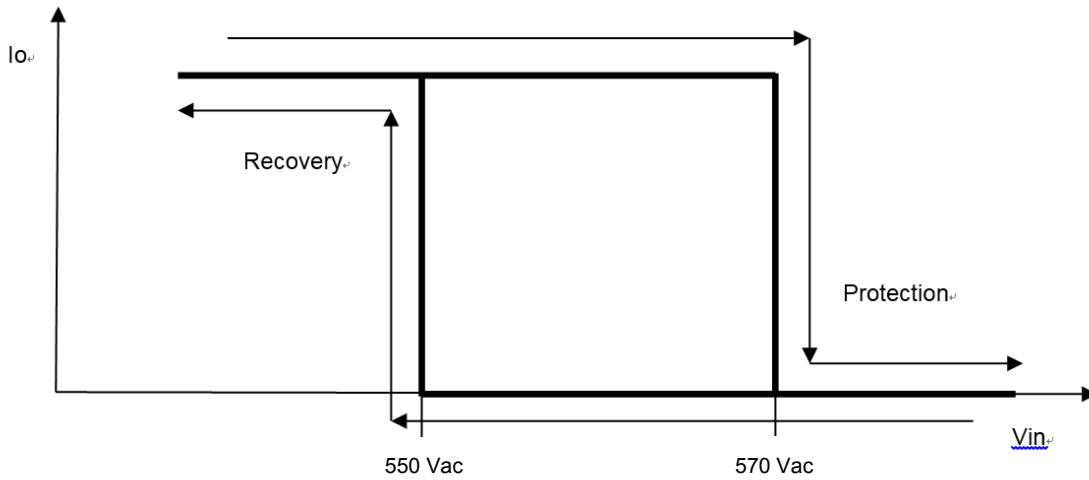

**Dimming**

● **0-10V Dimming**

The recommended implementation of the dimming control is provided below.

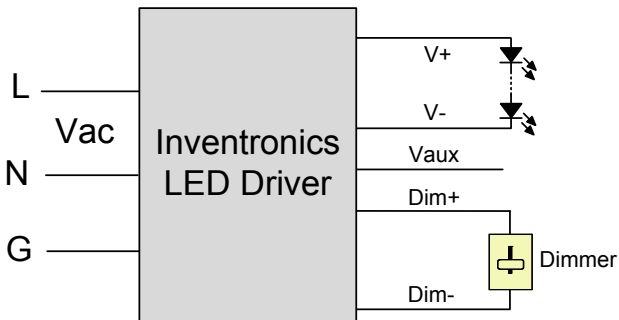

**$I_o/I_{o\text{set}}$  vs. Dimming Voltage**

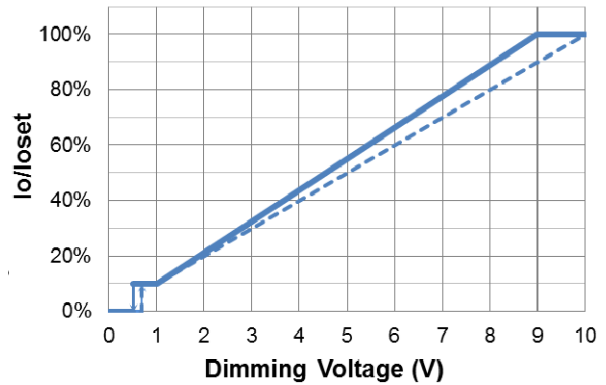

**$I_o/I_{o\text{set}}$  vs. Dimming Voltage**

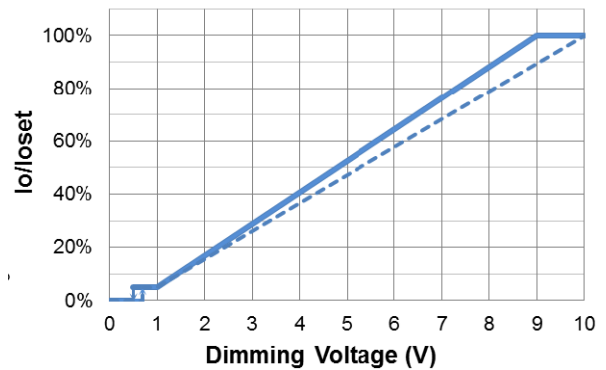

**Implementation 1: Positive logic**

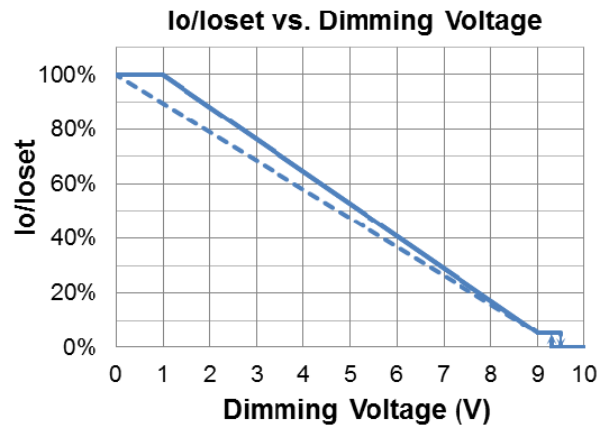
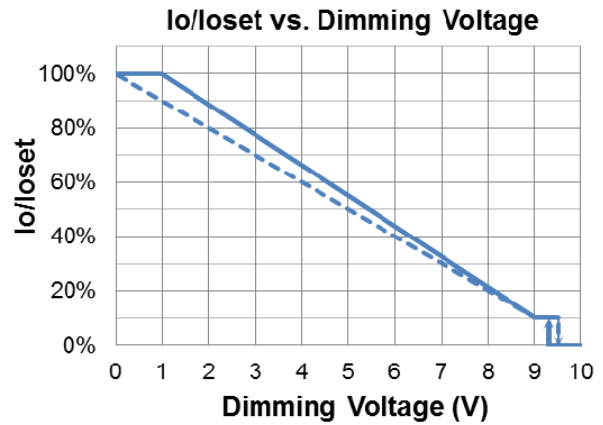
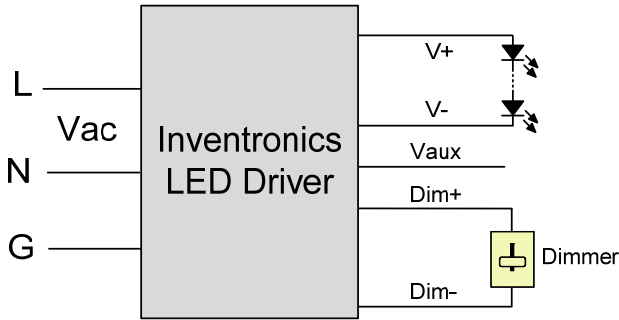

### Implementation 2: Negative logic

**Notes:**

1. Do NOT connect Dim- to the output V- or V+, otherwise the driver will not work properly.
2. The dimmer can also be replaced by an active 0-10V voltage source signal or passive components like zener.
3. When 0-10V negative logic dimming mode and Dim+ is open, the driver will dim to off and be standby..

● **PWM Dimming**

The recommended implementation of the dimming control is provided below.

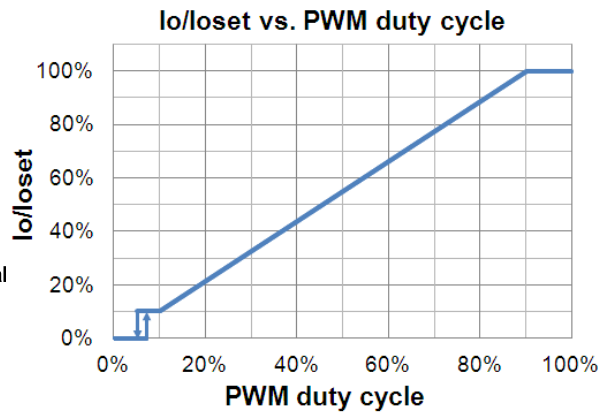
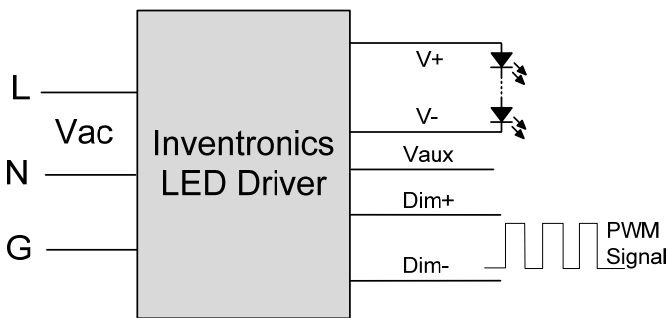

### Implementation 3: Positive logic

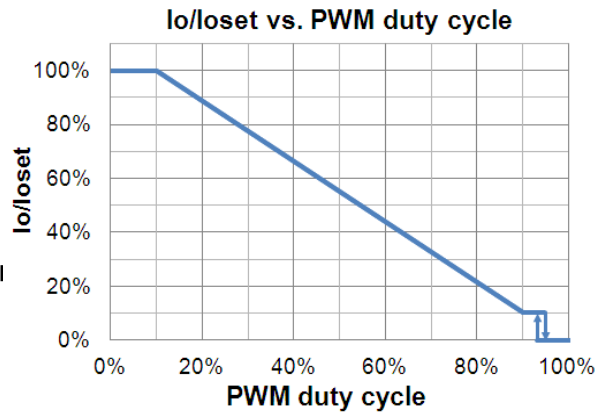
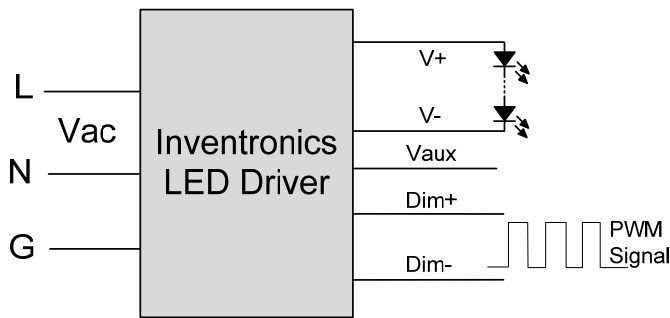

### Implementation 4: Negative logic

**Notes:**

1. Do NOT connect Dim- to the output V- or V+, otherwise the driver will not work properly.
2. When PWM negative logic dimming mode and Dim+ is open, the driver will dim to off and be standby..

● **Time Dimming**

Time dimming control includes 3 kinds of modes, they are Self Adapting-Midnight, Self Adapting-Percentage and Traditional Timer.

- **Self Adapting-Midnight:** Automatically adjusts the dimming curve based on the on-time of past two days (if difference <15 minutes), assuming that the center point of the dimming curve is midnight local time.
- **Self Adapting-Percentage:** Automatically adjusts the on-time of each step by a constant percentage = (actual on-time for the past 2 days if difference <15 min) / (programmed on-time from the dimming curve).
- **Traditional Timer:** Follows the programmed timing curve after power on with no changes.

● **Output Lumen Compensation**

Output Lumen Compensation (OLC) may be used to maintain constant light output over the life of the LEDs by driving them at a reduced current when new, then gradually increasing the drive current over time to counteract LED lumen degradation.

● **Minimum Dimming Level with 5% or 10% Selectable**

The minimum dimming level can be set as 5% or 10% by Inventronics Multi Programmer, 10% is default.

● **Maximum Dimming Level with 9V or 10V Selectable**

The maximum dimming level can be set as corresponding dimming voltage is 9V or 10V by Inventronics Multi Programmer, 9V is default.

● **Fade Time Adjustable**

Soft-start time and dimming slope can be adjusted by Inventronics Multi Programmer to get customized fade time experience, disable mode is default.

● **End Of Life**

End-of-Life (EOL) is providing a visual notification to a user that the LED module has reached the end of manufacturer-specified life and that the replacement is recommended. Once active, an indication is given at each power-up of the driver, which the driver indicates this through a lower light output during the first 1 minute before normal operation is continued.

● **Digital Dimming**

Inventronics Digital Dimming is a UART (Universal Asynchronous Receive Transmitter) based communication protocol. Please refer to [Inventronics Digital Dimming](#) file for details.



## Programming Connection Diagram

ESM-680SxxxMG

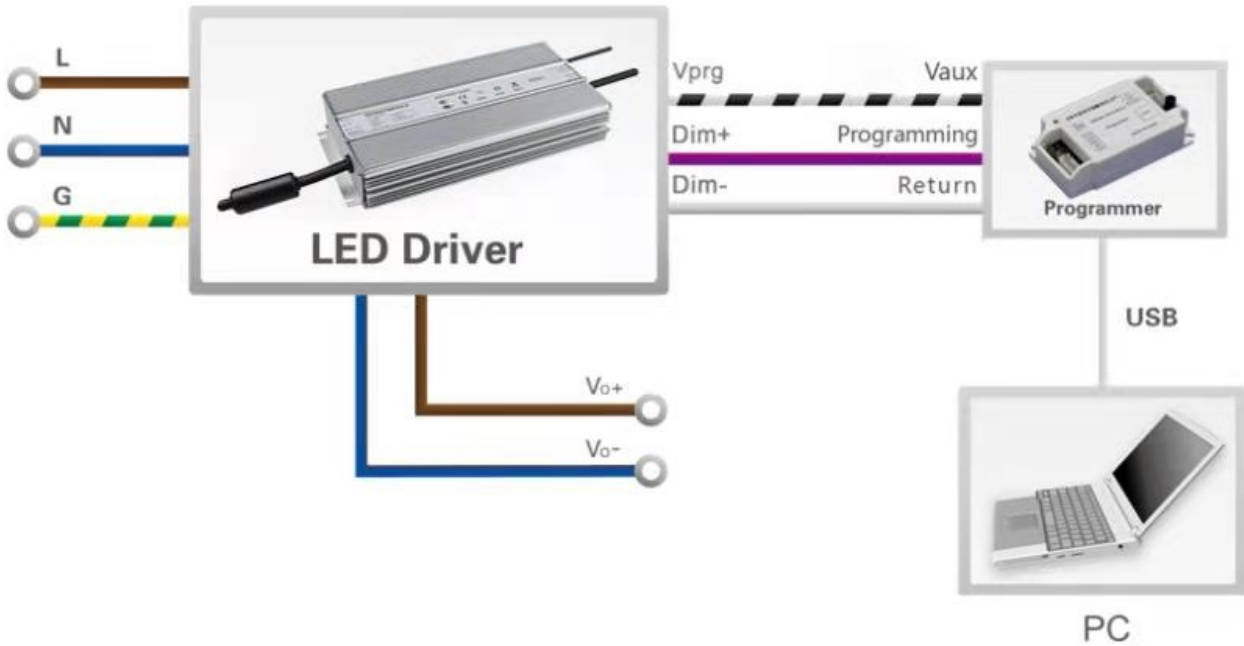

ESM-680SxxxMT

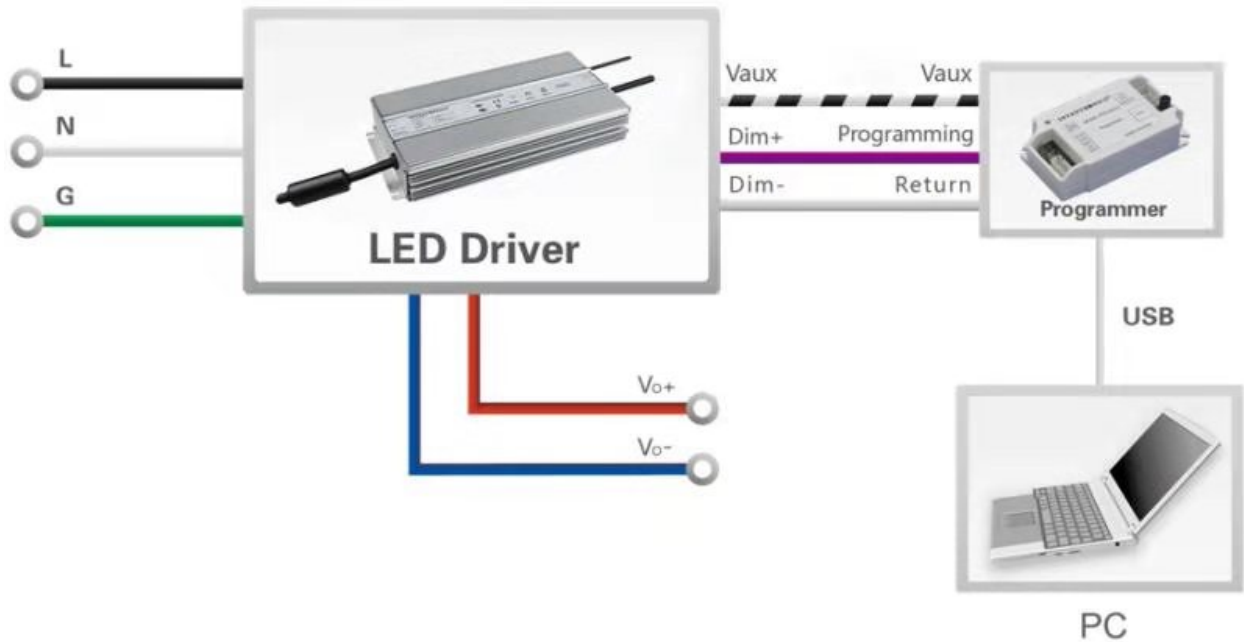

**Note:** The driver does not need to be powered on during the programming process

- Please refer to [PRG-MUL2](#) (Programmer) datasheet for details.

## Mechanical Outline

### ESM-680S170/240MG

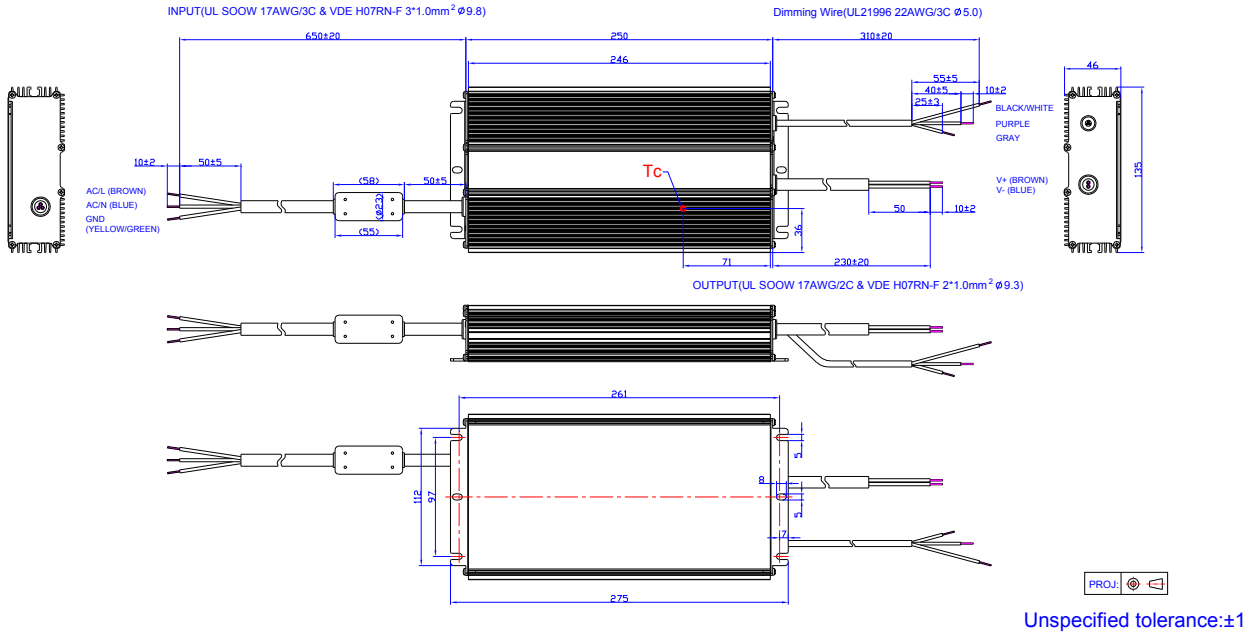

### ESM-680S350/560/840MG

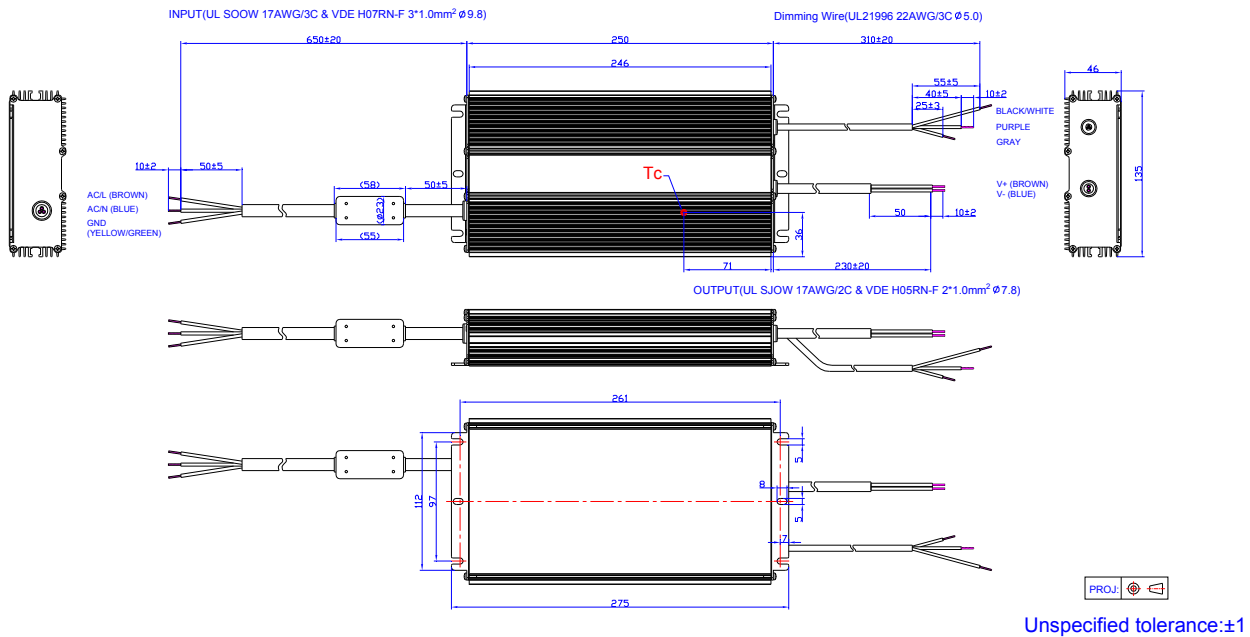

## ESM-680S15AMG

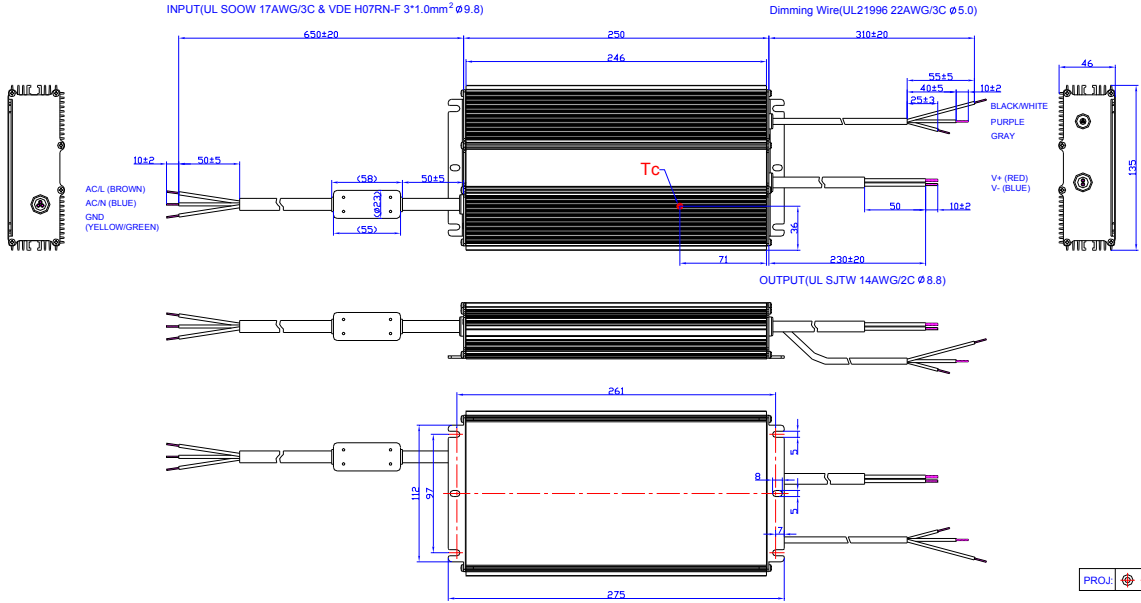

Unspecified tolerance: ±1

## ESM-680S170/240MT

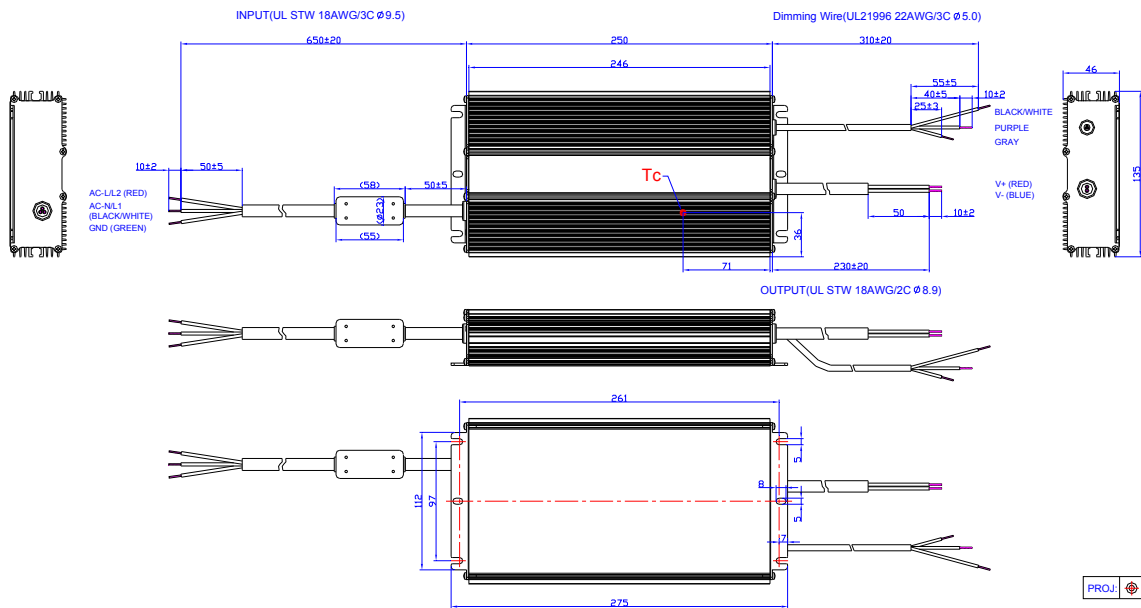

Unspecified tolerance: ±1

## ESM-680S350/560/840MT

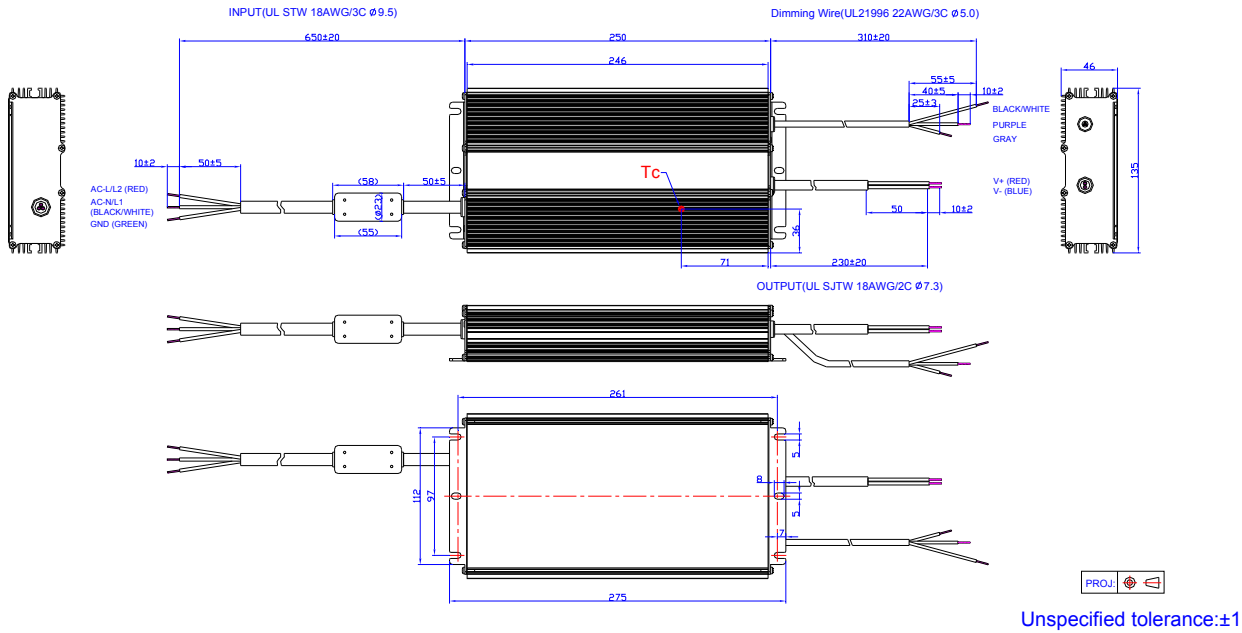

## ESM-680S15AMT

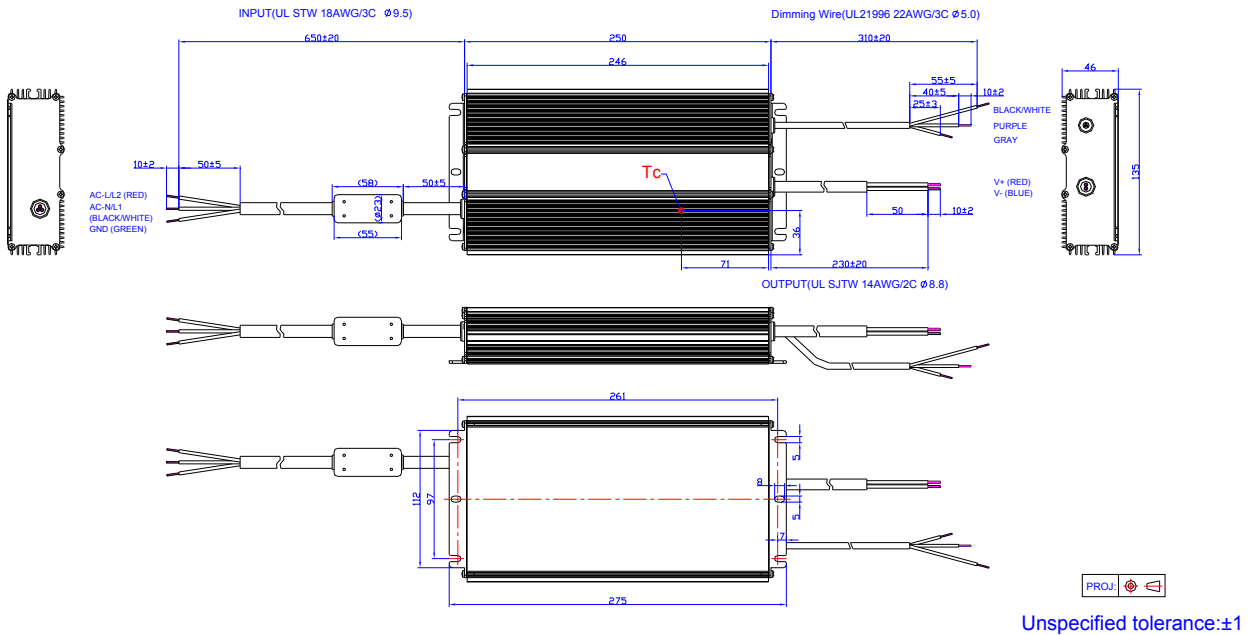

## RoHS Compliance

Our products comply with reference to RoHS Directive (EU) 2015/863 amending 2011/65/EU, calling for the elimination of lead and other hazardous substances from electronic products.

## Revision History

Change Date	Rev.	Description of Change		
		Item	From	To
2021-04-20	A	Datasheet Release	/	/