

## Features

- Ultra High Efficiency (Up to 93.0%)
- Full Power at Wide Output Current Range (Constant Power)
- Thermal Sensing and Protection for LED Module
- 0-10V/PWM/Timer Dimmable (3 Timer Modes)
- Dim-to-Off with Standby Power  $\leq 0.5$  W
- Always-on Auxiliary Power: 12Vdc, 200mA (Transient Peak Current up to 400mA)
- Output Lumen Compensation
- Input Surge Protection: 6kV line-line, 10kV line-earth
- All-Around Protection: OVP, SCP, OTP
- Waterproof (IP67) and UL Dry / Damp / Wet Location
- Class 2 & SELV Output
- TYPE HL, for use in a Class I, Division 2 hazardous (Classified) location
- Class P, UL Listed Versions Available (See Note 6)
- 7 Years Warranty



## Description

The EUD-096SxxxDTA series is a 96W, constant-current, programmable LED driver that operates from 90-305 Vac input with excellent power factor. Created for low bay, tunnel and street lights, it provides a dim-to-off mode with low standby power. The high efficiency of these drivers and compact metal case enables them to run cooler, significantly improving reliability and extending product life. To ensure trouble-free operation, protection is provided against input surge, output over voltage, short circuit, and over temperature.

## Models

Adjustable Output Current Range	Full-Power Current Range(1)	Default Output Current	Input Voltage Range(2)	Output Voltage Range	Max. Output Power	Typical Efficiency (3)	Power Factor		Model Number
							120Vac	220Vac	
45-700mA	450-700mA	530 mA	90~305 Vac/ 127~300 Vdc	74~213Vdc	96 W	91.5%	0.99	0.96	EUD-096S070DTA
70-1050mA	700-1050mA	700 mA	90~305 Vac/ 127~300 Vdc	48~137Vdc	96 W	92.5%	0.99	0.96	EUD-096S105DTA
140-2100mA	1400-2100mA	2100 mA	90~305 Vac/ 127~300 Vdc	24 ~ 69Vdc	96 W	93.0%	0.99	0.96	EUD-096S210DTA <sup>(4)</sup>
175-2150mA	1750-2150mA	2100 mA	90~305 Vac/ 127~300 Vdc	24 ~ 55Vdc	96 W	92.5%	0.99	0.96	EUD-096S215DTA <sup>(5)</sup>
245-3500mA	2450-3500mA	2800 mA	90~305 Vac/ 127~300 Vdc	14 ~ 39Vdc	96 W	91.0%	0.99	0.96	EUD-096S350DTA <sup>(5)</sup>

- Notes:** (1) Output current range with constant power at 96W  
 (2) Certified input voltage range: UL, FCC 100-277Vac or 127-300Vdc; otherwise 100-240Vac or 127-250Vdc (except KS).  
 (3) Measured at full load and 220Vac input (see below "General Specifications" for details).  
 (4) SELV Output.  
 (5) Class 2 & SELV Output.  
 (6) Standard part UL Type TL. For UL Listed Class P models add suffix -00C0.

## I-V Operating Area

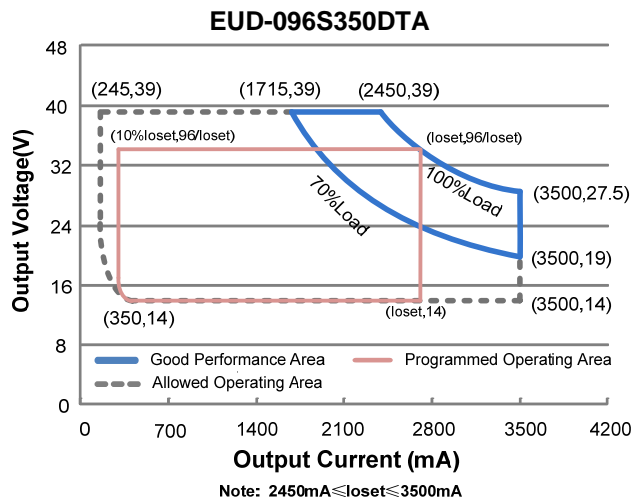
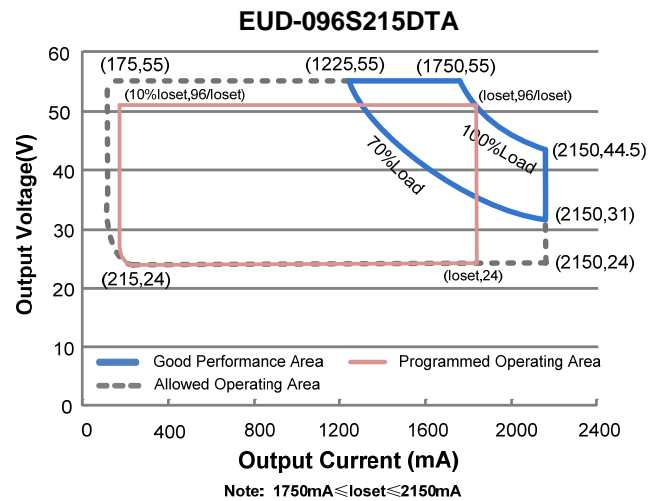
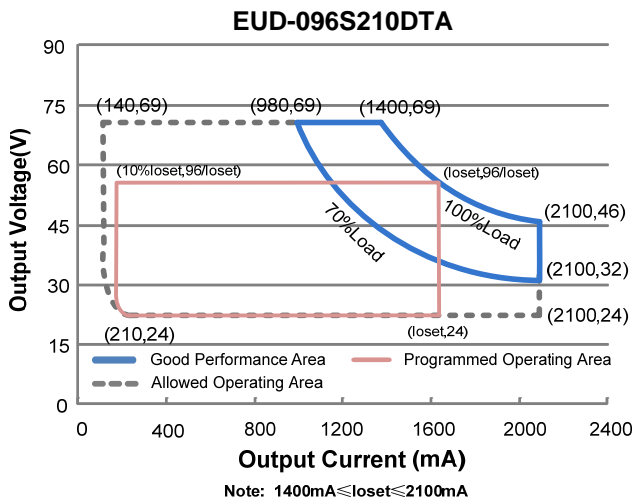
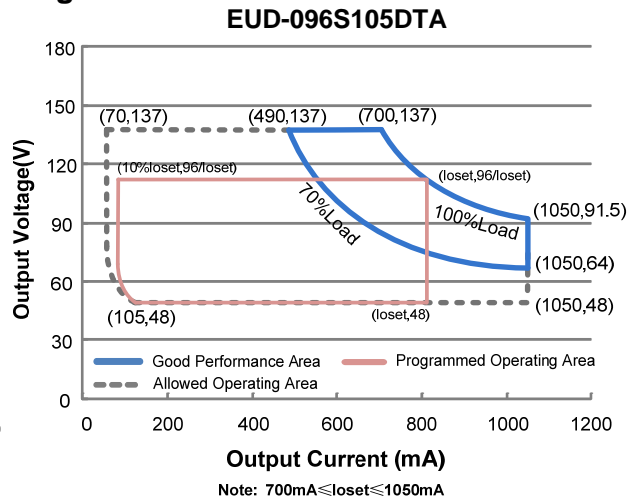
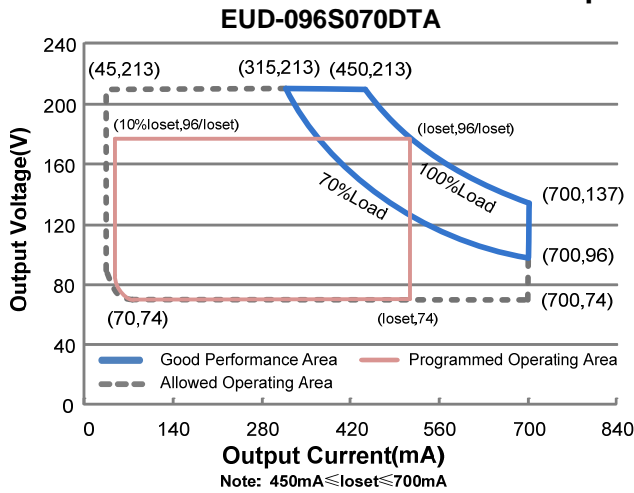

## Input Specifications

Parameter	Min.	Typ.	Max.	Notes
Input Voltage	90 Vac	-	305 Vac	127-300Vdc
Input Frequency	47 Hz	-	63 Hz	
Leakage Current	-	-	0.75 MIU	UL8750; 277Vac/ 60Hz
	-	-	0.70 mA	IEC60598-1; 240Vac/ 60Hz
Input AC Current	-	-	1.32 A	Measured at full load and 100 Vac input.
	-	-	0.60 A	Measured at full load and 220 Vac input.
Inrush Current(I <sup>2</sup> t)	-	-	1.10 A <sup>2</sup> s	At 220Vac input, 25°C cold start, duration=576 μs, 10%Ipk-10%Ipk. See Inrush Current Waveform for the details.
PF	0.90	-	-	At 100-277Vac, 50-60Hz, 70%-100% Load (67-96W)
THD	-	-	20%	
THD	-	-	10%	At 220-240Vac, 50-60Hz, 75%-100% Load (72-96W)

## Output Specifications

Parameter	Min.	Typ.	Max.	Notes
Output Current Tolerance	-5%loset	-	5%loset	At full load condition
Output Current Setting(loset) Range				
EUD-096S070DTA	45 mA	-	700 mA	
EUD-096S105DTA	70 mA	-	1050 mA	
EUD-096S210DTA	140 mA	-	2100 mA	
EUD-096S215DTA	175 mA	-	2150 mA	
EUD-096S350DTA	245 mA	-	3500 mA	
Output Current Setting Range with Constant Power				
EUD-096S070DTA	450 mA	-	700 mA	
EUD-096S105DTA	700 mA	-	1050 mA	
EUD-096S210DTA	1400 mA	-	2100 mA	
EUD-096S215DTA	1750 mA	-	2150 mA	
EUD-096S350DTA	2450 mA	-	3500 mA	
Total Output Current Ripple (pk-pk)	-	5%lomax	10%lomax	At full load condition, 20 MHz BW
Output Current Ripple at < 200 Hz (pk-pk)	-	2%lomax	-	At full load condition. Only this component of ripple is associated with visible flicker.
Startup Overshoot Current	-	-	10%lomax	At full load condition
No Load Output Voltage				
EUD-096S070DTA	-	-	240 V	
EUD-096S105DTA	-	-	170 V	
EUD-096S210DTA	-	-	90 V	
EUD-096S215DTA	-	-	59 V	
EUD-096S350DTA	-	-	44 V	
Line Regulation	-	-	±0.5%	Measured at full load
Load Regulation	-	-	±1.5%	

## Output Specifications (Continued)

Parameter	Min.	Typ.	Max.	Notes
Turn-on Delay Time	-	-	1.0 s	Measured at 120Vac input, 70%-100% Load
	-	-	0.5 s	Measured at 220Vac input, 70%-100% Load
Temperature Coefficient of I <sub>o</sub> set	-	0.03%/°C	-	Case temperature = 0°C ~T <sub>c</sub> max
12V Auxiliary Output Voltage	10.8 V	12 V	13.2 V	
12V Auxiliary Output Source Current	0 mA	-	200 mA	Return terminal is "Dim"
12V Auxiliary Output Transient Peak Current	-	-	400 mA	400mA peak for a maximum duration of 300ms in a 2s period during which time the average should not exceed 200mA.

**Note:** All specifications are typical at 25°C unless otherwise stated.

## General Specifications

Parameter	Min.	Typ.	Max.	Notes
Efficiency at 120 Vac input:				Measured at full load and steady-state temperature in 25°C ambient; (Efficiency will be about 2.0% lower if measured immediately after startup.)
EUD-096S070DTA				
I <sub>o</sub> = 450 mA	87.0%	90.0%	-	
I <sub>o</sub> = 700 mA	85.5%	88.5%	-	
EUD-096S105DTA				
I <sub>o</sub> = 700 mA	88.0%	91.0%	-	
I <sub>o</sub> = 1050 mA	86.5%	89.5%	-	
EUD-096S210DTA				
I <sub>o</sub> = 1400 mA	88.0%	91.0%	-	
I <sub>o</sub> = 2100 mA	86.0%	89.0%	-	
EUD-096S215DTA				
I <sub>o</sub> = 1750 mA	87.5%	90.5%	-	
I <sub>o</sub> = 2150 mA	85.5%	88.5%	-	
EUD-096S350DTA				
I <sub>o</sub> = 2450 mA	86.5%	89.5%	-	
I <sub>o</sub> = 3500 mA	84.5%	87.5%	-	
Efficiency at 220 Vac input:				Measured at full load and steady-state temperature in 25°C ambient; (Efficiency will be about 2.0% lower if measured immediately after startup.)
EUD-096S070DTA				
I <sub>o</sub> = 450 mA	89.5%	91.5%	-	
I <sub>o</sub> = 700 mA	88.5%	90.5%	-	
EUD-096S105DTA				
I <sub>o</sub> = 700 mA	90.5%	92.5%	-	
I <sub>o</sub> = 1050 mA	88.5%	90.5%	-	
EUD-096S210DTA				
I <sub>o</sub> = 1400 mA	91.0%	93.0%	-	
I <sub>o</sub> = 2100 mA	88.5%	90.5%	-	
EUD-096S215DTA				
I <sub>o</sub> = 1750 mA	90.5%	92.5%	-	
I <sub>o</sub> = 2150 mA	88.0%	90.0%	-	
EUD-096S350DTA				
I <sub>o</sub> = 2450 mA	89.0%	91.0%	-	
I <sub>o</sub> = 3500 mA	87.5%	89.5%	-	

## General Specifications (Continued)

Parameter	Min.	Typ.	Max.	Notes
Efficiency at 277 Vac input: EUD-096S070DTA I <sub>o</sub> = 450 mA I <sub>o</sub> = 700 mA EUD-096S105DTA I <sub>o</sub> = 700 mA I <sub>o</sub> = 1050 mA EUD-096S210DTA I <sub>o</sub> = 1400 mA I <sub>o</sub> = 2100 mA EUD-096S215DTA I <sub>o</sub> = 1750 mA I <sub>o</sub> = 2150 mA EUD-096S350DTA I <sub>o</sub> = 2450 mA I <sub>o</sub> = 3500 mA	90.0% 88.5% 91.0% 89.0% 91.0% 89.0% 90.5% 88.5% 89.5% 87.5%	92.0% 90.5% 93.0% 91.0% 93.0% 91.0% 92.5% 90.5% 91.5% 89.5%	- - - - - - - - - -	Measured at full load and steady-state temperature in 25°C ambient; (Efficiency will be about 2.0% lower if measured immediately after startup.)
Standby power	-	-	0.5 W	Measured at 230Vac/50Hz; Dimming off
MTBF	-	229,000 Hours	-	Measured at 220Vac input, 80%Load and 25°C ambient temperature (MIL-HDBK-217F)
Lifetime	-	104,000 Hours	-	Measured at 220Vac input, 80%Load and 70°C case temperature; See lifetime vs. Tc curve for the details
Operating Case Temperature for Safety T <sub>c_s</sub>	-40°C	-	+90°C	
Operating Case Temperature for Warranty T <sub>c_w</sub>	-40°C	-	+75°C	Case temperature for 7 years warranty. Please see <i>Inventronics Warranty Statement</i> for complete details.
Storage Temperature	-40°C	-	+85°C	Humidity: 5%RH to 100%RH
Dimensions Inches (L × W × H) Millimeters (L × W × H)	7.09 × 2.66 × 1.44 180 × 67.5 × 36.5			With mounting ear 7.92 × 2.66 × 1.44 201 × 67.5 × 36.5
Net Weight	-	960 g	-	

**Note:** All specifications are typical at 25°C unless otherwise stated.

## Dimming Specifications

Parameter	Min.	Typ.	Max.	Notes
Absolute Maximum Voltage on the V <sub>dim</sub> (+) Pin	-20 V	-	20 V	
Source Current on V <sub>dim</sub> (+)Pin	200 uA	300 uA	450 uA	V <sub>dim</sub> (+) = 0 V

## Dimming Specifications (Continued)

Parameter		Min.	Typ.	Max.	Notes
Dimming Output Range	EUD-096S070DTA EUD-096S105DTA EUD-096S210DTA EUD-096S215DTA EUD-096S350DTA	10%I <sub>load</sub>	-	I <sub>load</sub>	450mA ≤ I <sub>load</sub> ≤ 700mA 700mA ≤ I <sub>load</sub> ≤ 1050mA 1400mA ≤ I <sub>load</sub> ≤ 2100mA 1750mA ≤ I <sub>load</sub> ≤ 2150mA 2450mA ≤ I <sub>load</sub> ≤ 3500mA
	EUD-096S070DTA EUD-096S105DTA EUD-096S210DTA EUD-096S215DTA EUD-096S350DTA	45mA 70mA 140mA 175mA 245mA	-	I <sub>load</sub>	45mA ≤ I <sub>load</sub> < 450mA 70mA ≤ I <sub>load</sub> < 700mA 140mA ≤ I <sub>load</sub> < 1400mA 175mA ≤ I <sub>load</sub> < 1750mA 245mA ≤ I <sub>load</sub> < 2450mA
Recommended Dimming Input Range		0 V	-	10 V	Default 0-10V dimming mode.
Dim off Voltage		0.35 V	0.5 V	0.65 V	
Dim on Voltage		0.55 V	0.7 V	0.85 V	
Hysteresis		-	0.2 V	-	
PWM_in High Level		3 V	-	10 V	Dimming mode set to PWM in PC interface.
PWM_in Low Level		-0.3 V	-	0.6 V	
PWM_in Frequency Range		200 Hz	-	3 KHz	
PWM_in Duty Cycle		1%	-	99%	
PWM Dimming off (Positive Logic)		2%	5%	8%	
PWM Dimming on (Positive Logic)		4%	7%	10%	
PWM Dimming off ( Negative Logic)		92%	95%	98%	
PWM Dimming on ( Negative Logic)		90%	93%	96%	
Hysteresis		-	2%	-	

**Note:** All specifications are typical at 25 °C unless stated otherwise.

## Safety & EMC Compliance

Safety Category	Standard
UL/CUL	UL 8750, UL 1310, CAN/CSA-C22.2 No. 250.13, CAN/CSA-C22.2 No. 223-M91
CE	EN 61347-1, EN61347-2-13
KS	KS C 7655
EMI Standards	Notes
EN 55015 <sup>(1)</sup>	Conducted emission Test & Radiated emission Test
EN 61000-3-2	Harmonic current emissions
EN 61000-3-3	Voltage fluctuations & flicker

## Safety & EMC Compliance (Continued)

EMI Standards	Notes
FCC Part 15 <sup>(1)</sup>	ANSI C63.4 Class B
	This device complies with Part 15 of the FCC Rules. Operation is subject to the following two conditions: [1] this device may not cause harmful interference, and [2] this device must accept any interference received, including interference that may cause undesired Operation.
EMS Standards	Notes
EN 61000-4-2	Electrostatic Discharge (ESD): 8 kV air discharge, 4 kV contact discharge
EN 61000-4-3	Radio-Frequency Electromagnetic Field Susceptibility Test-RS
EN 61000-4-4	Electrical Fast Transient / Burst-EFT
EN 61000-4-5	Surge Immunity Test: AC Power Line: line to line 6 kV, line to earth 10 kV <sup>(2)</sup>
EN 61000-4-6	Conducted Radio Frequency Disturbances Test-CS
EN 61000-4-8	Power Frequency Magnetic Field Test
EN 61000-4-11	Voltage Dips
EN 61547	Electromagnetic Immunity Requirements Applies To Lighting Equipment

- Note:** (1) This LED driver meets the EMI specifications above, but EMI performance of a luminaire that contains it depends also on the other devices connected to the driver and on the fixture itself.  
 (2) To perform electric strength (hi-pot) testing, the “GDT ground disconnect” (nut and metal lock sheet) on the driver end-cap should be removed temporarily to prevent the internal gas discharge tube from conducting (as allowed by IEC 60598-1 Clause 10.2). After testing is completed, these items must be reinstalled to restore line-to-earth surge protection and secure the end cap.

## Lifetime vs. Case Temperature

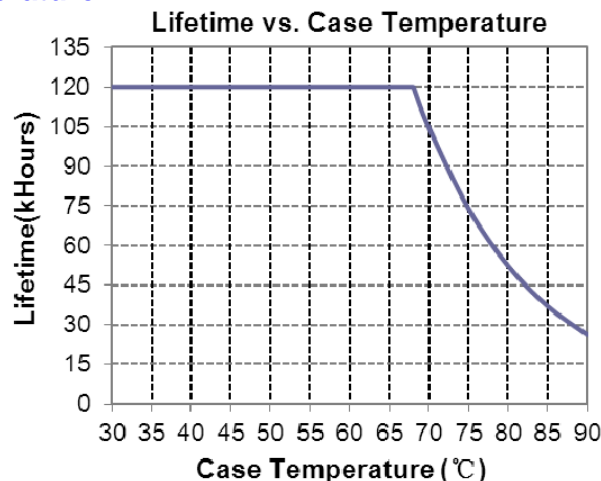

## Inrush Current Waveform

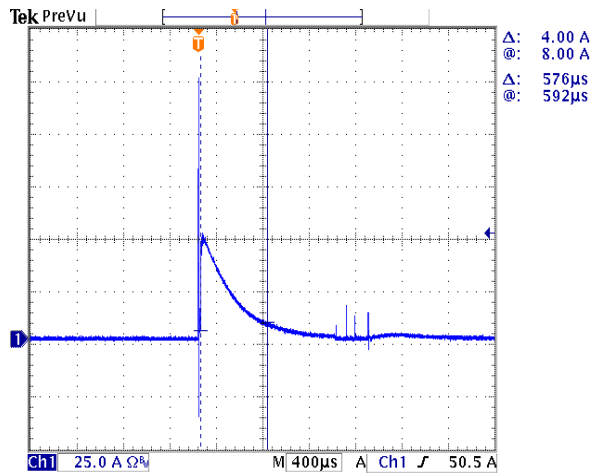

## Efficiency vs. Load

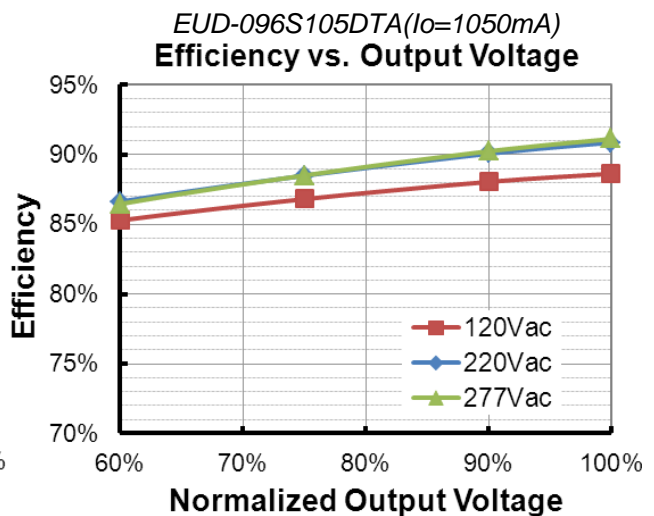
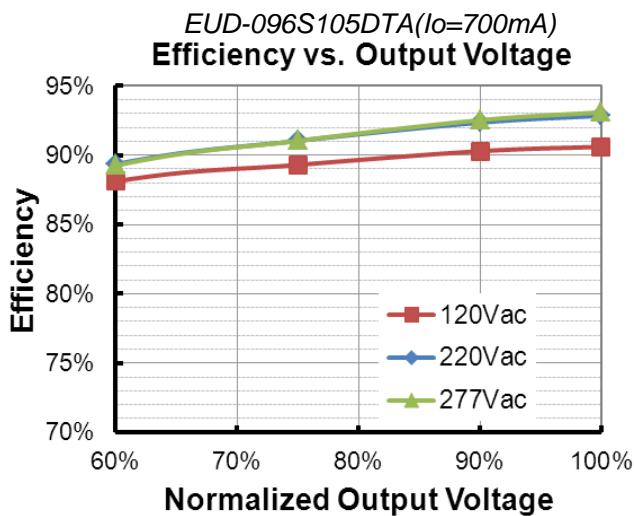
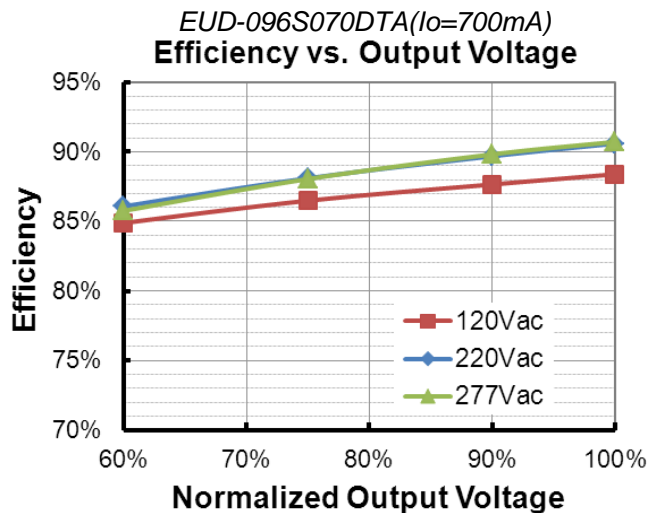
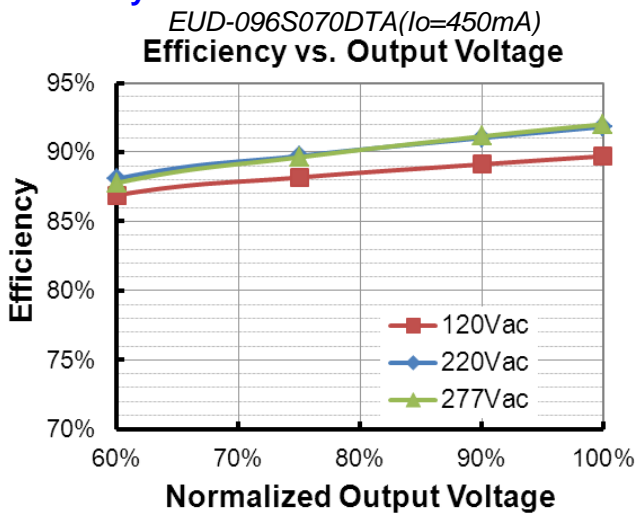



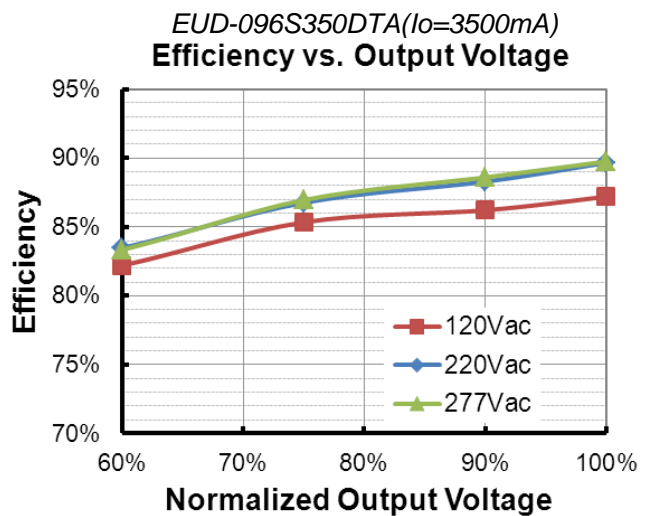
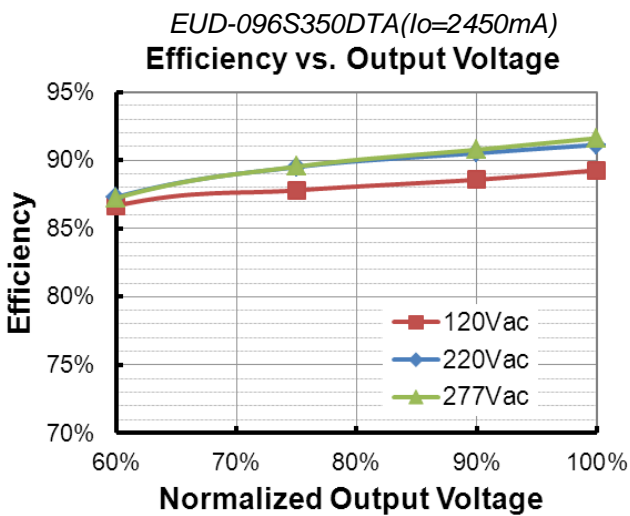
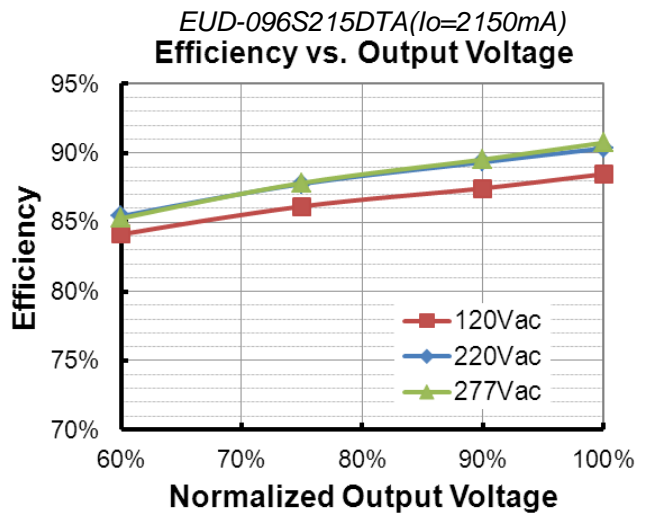
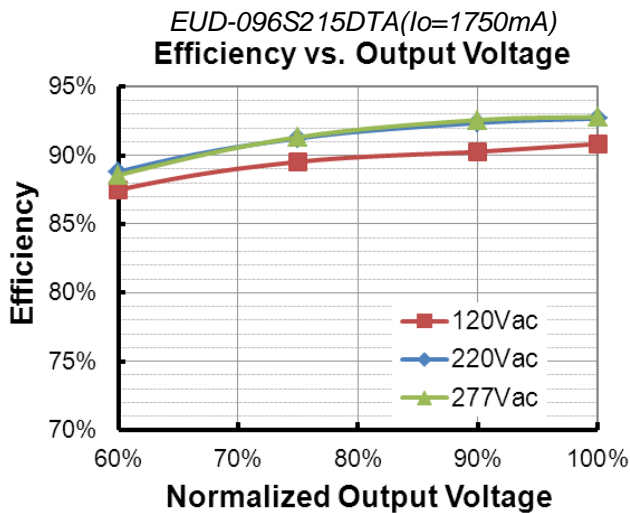
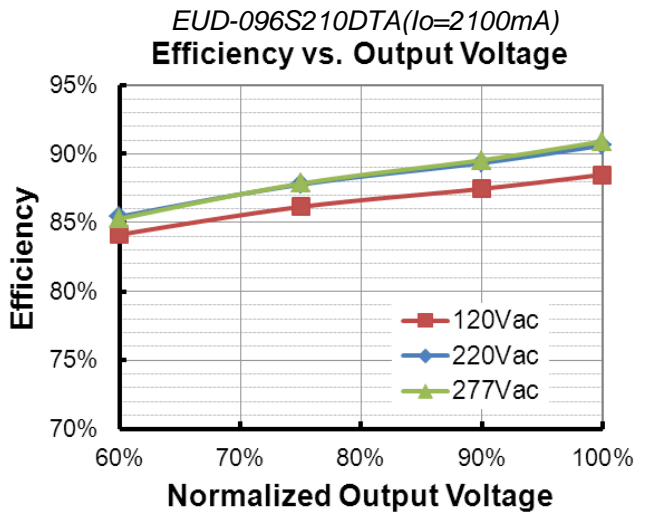
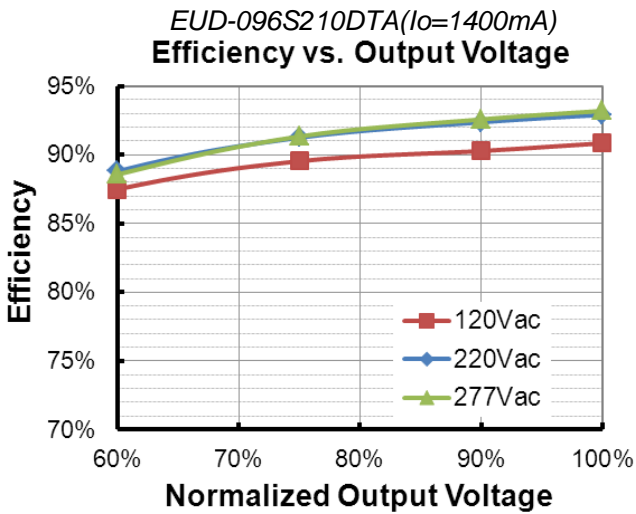

## Power Factor

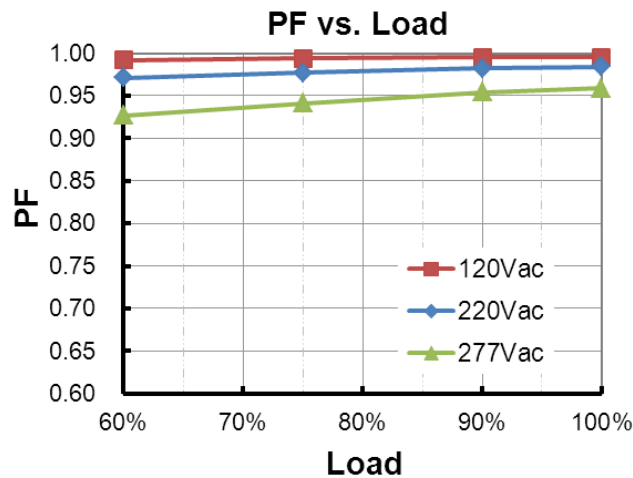

## Total Harmonic Distortion

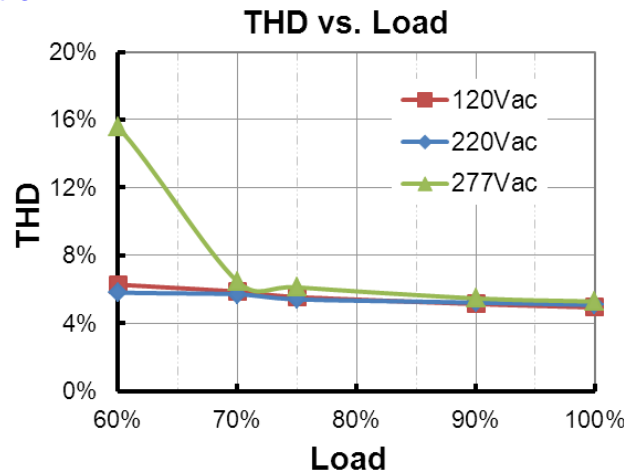

## Protection Functions

Parameter		Min.	Typ.	Max.	Notes
External Thermal Protection NTC	R1	-	7.81 kOhm	-	When R_NTC falls below R1, External Thermal Protection is triggered, reducing output current until R2 is reached.
	R2	-	4.16 kOhm	-	When R_NTC is less than R2, output current is reduced to the programmed "Protection Current Floor."
	Protection Current Floor	10%loset	60%loset	100%loset	10%loset > lomin (default setting is 60%)
		lomin	60%loset	100%loset	10%loset ≤ lomin (default setting is 60%)
Over Temperature Protection	Decreases output current, returning to normal after over temperature is removed.				
Short Circuit Protection	Auto Recovery. No damage will occur when any output is short circuited. The output shall return to normal when the fault condition is removed.				
Over Voltage Protection	Limits output voltage at no load and in case the normal voltage limit fails.				

## Dimming

### ● 0-10V Dimming

The recommended implementation of the dimming control is provided below.

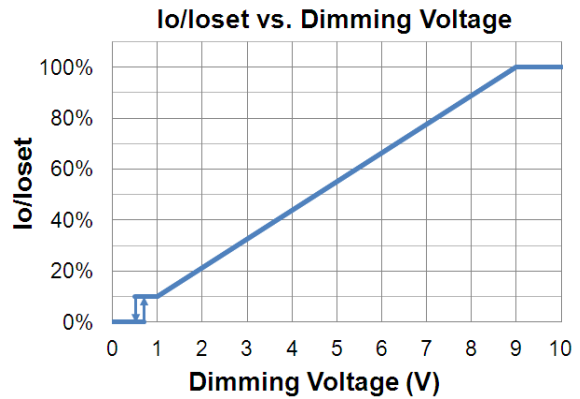
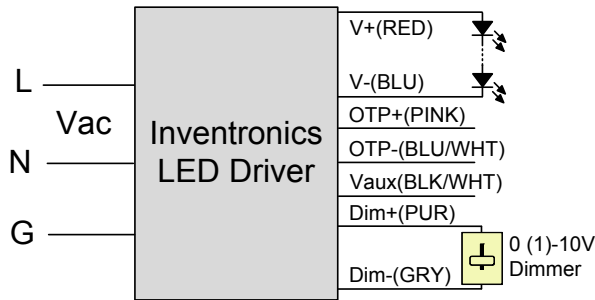

Implementation 1: DC Input

### Notes:

1. The dimmer can also be replaced by an active 0-10V voltage source signal or passive components like resistors and zener.
2. Do NOT connect Dim- to the output V- or V+, otherwise the driver will not work properly.
3. If 0-10V dimming is not used, Dim + should be open.

### ● PWM Dimming

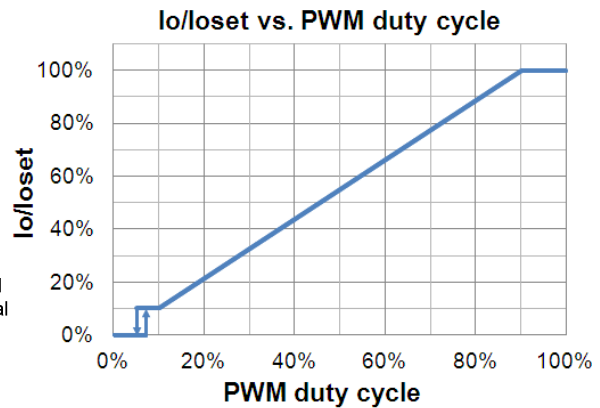
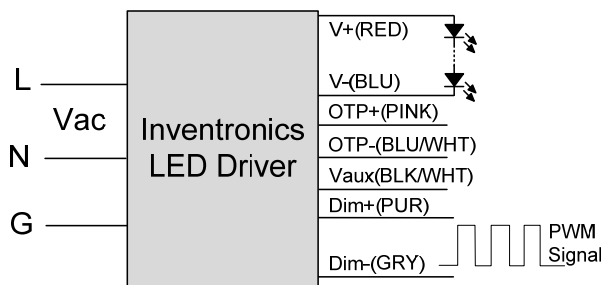

Implementation 2: Positive logic

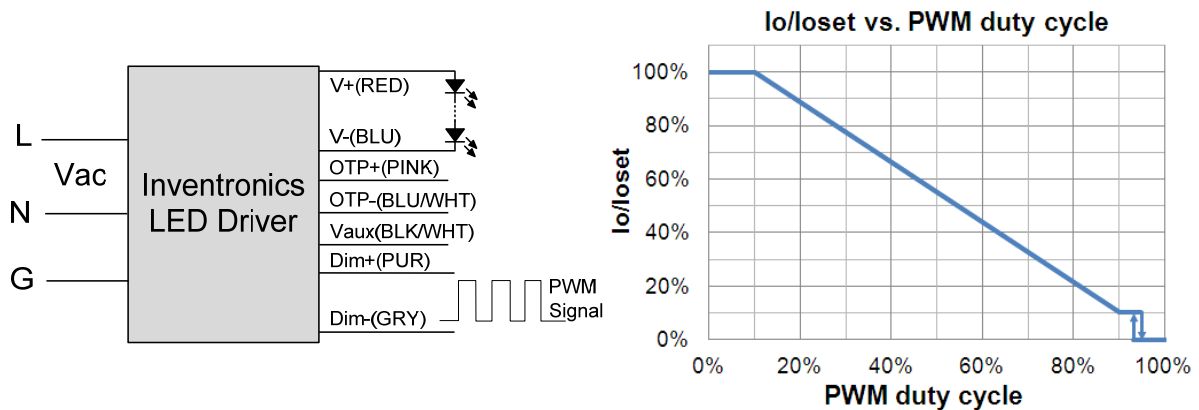

### Implementation 3: Negative logic

#### ● Time Dimming

Time dimming control includes 3 kinds of modes, they are Self Adapting-Midnight, Self Adapting-Percentage and Traditional Timer.

- **Self Adapting-Midnight:** Automatically adjusts the dimming curve based on the on-time of past two days (if difference <15 minutes), assuming that the center point of the dimming curve is midnight local time.
- **Self Adapting-Percentage:** Automatically adjusts the on-time of each step by a constant percentage = (actual on-time for the past 2 days if difference <15 min) / (programmed on-time from the dimming curve).
- **Traditional Timer:** Follows the programmed timing curve after power on with no changes.

#### ● Output Lumen Compensation

Output Lumen Compensation (OLC) may be used to maintain constant light output over the life of the LEDs by driving them at a reduced current when new, then gradually increasing the drive current over time to counteract LED lumen degradation.

### Programming Connection Diagram

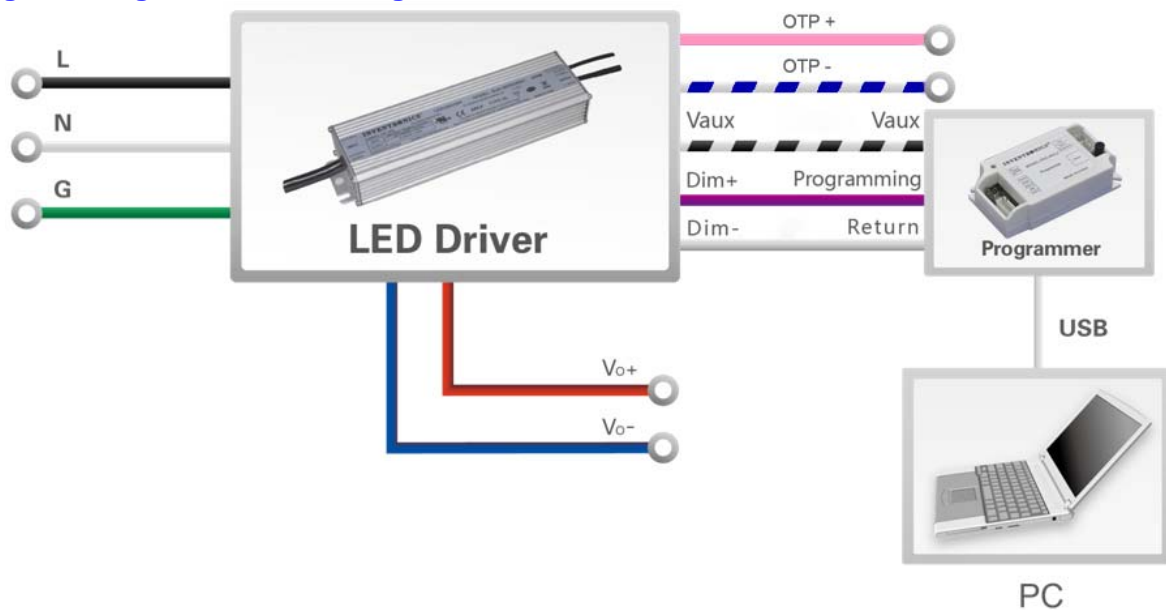

**Note:** The driver does not need to be powered on during the programming process.

- Please refer to [PRG-MUL2](#) (Programmer) datasheet for details.

## Mechanical Outline

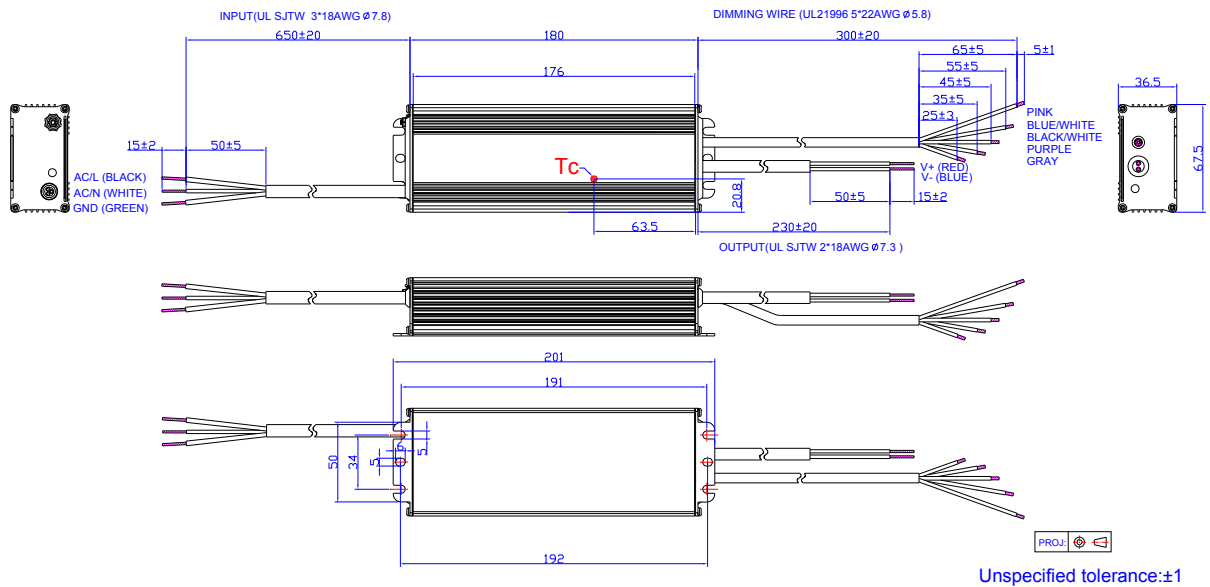

## RoHS Compliance

Our products comply with the European Directive 2011/65/EC, calling for the elimination of lead and other hazardous substances from electronic products.

## Revision History

Change Date	Rev.	Description of Change		
		Item	From	To
2016-07-05	A	Datasheets Release	/	/
2017-03-31	B	EUD-096S215DTA	/	Added
		I-V Operation Area	EUD-096S215DTA	Added
		Output Specifications	Output Current Setting(losset) Range	Updated
		Output Specifications	Output Current Setting Range with Constant Power	Updated
		Output Specifications	No Load Output Voltage	Updated
		General Specifications	Efficiency at 120 Vac input	Updated
		General Specifications	Efficiency at 220 Vac input	Updated
		General Specifications	Efficiency at 277 Vac input	Updated
		Dimming Specifications	Dimming Output Range	Updated
		Safety & EMC Compliance	/	Updated
		Efficiency vs. Load	EUD-096S215DTA	Added
Mechanical Outline	/	Updated		
2017-10-27	C	Features	Always-on Auxiliary Power	Added
		Features	Class P, UL Listed Versions Available (See Note 6)	Added
		Features	7 Years Warranty	Added
		Models	(6) Standard part UL Type TL. For UL Listed Class P models add suffix -00C0.	Added
		Input Specifications	PF/THD	Updated
		Output Specifications	12V Auxilliary Output Transient Peak Current	Added
		Operating Case Temperature for Warranty Tc_w	/	Updated