

Features

- Full Power at Wide Output Current Range (Constant Power)
- Adjustable Output Current (AOC) with NFC
- DALI-2 and D4i Certified
- 3-Timer-Modes Dimmable
- Dim-to-Off with Standby Power ≤ 0.5 W
- Always-on Auxiliary Power: 24Vdc, 125mA, 3W (Transient Peak Power up to 10W)
- Integrated 16Vdc Bus Power Supply based on DALI-2
- Integrated Power Monitoring with High Accuracy up to $\pm 1\%$
- Output Lumen Compensation
- End-of-Life Indicator
- Thermal Sensing and Protection for LED Module
- Input Surge Protection: DM 6kV, CM 10kV
- All-Around Protection: IUVP, IOVP, OVP, SCP, OTP
- IP66 / IP67 and UL Dry / Damp / Wet Location
- TYPE HL, for Use in a Class I, Division 2 Hazardous (Classified) Location
- 7 Year Warranty



Description

The EUM-200SxxxBx series is a 200W, constant-current, NFC programmable and IP66/IP67 rated LED driver that operates from 90-305Vac input with excellent power factor. Created for intra-luminaire solutions and health monitoring applications, this family provides integrated AC power monitoring with an auxiliary voltage and dim-to-off functionality for powering low voltage, wireless controls. The dimming control supports two-way communication via DALI-2 and complies with D4i. The high efficiency of these drivers and compact metal case enables them to run cooler, significantly improving reliability and extending product life. To ensure trouble-free operation, protection is provided against input surge, input under voltage, input over voltage, output over voltage, short circuit, and over temperature.

Models

Adjustable Output Current Range	Full-Power Current Range(1)	Default Output Current	Input Voltage Range(2)	Output Voltage Range	Max. Output Power	Typical Efficiency (3)	Typical Power Factor		Model Number (5)
							120Vac	220Vac	
70-1050mA	700-1050mA	700 mA	90~305 Vac/ 127~300 Vdc	95~286 Vdc	200 W	93.5%	0.99	0.96	EUM-200S105Bx
105-1500mA	1050-1500mA	1050 mA	90~305 Vac/ 127~300 Vdc	67~190 Vdc	200 W	93.5%	0.99	0.96	EUM-200S150Bx
180-2800mA	1800-2800mA	2100 mA	90~305 Vac/ 127~300 Vdc	36~111 Vdc	200 W	93.0%	0.99	0.96	EUM-200S280Bx ⁽⁴⁾
350-5600mA	3500-5600mA	4200 mA	90~305 Vac/ 127~300 Vdc	18 ~ 57 Vdc	200 W	92.0%	0.99	0.96	EUM-200S560Bx ⁽⁴⁾

- Notes:** (1) Output current range with constant power at 200W
 (2) Certified input voltage range: UL, FCC 100-277Vac; otherwise 100-240Vac.
 (3) Measured at 100%load and 220Vac input (see below "General Specifications" for details).
 (4) SELV output.
 (5) x = G are UL Recognized, ENEC and CCC, etc. models; x = T are UL Class P models; x = B are BIS models.

I-V Operation Area

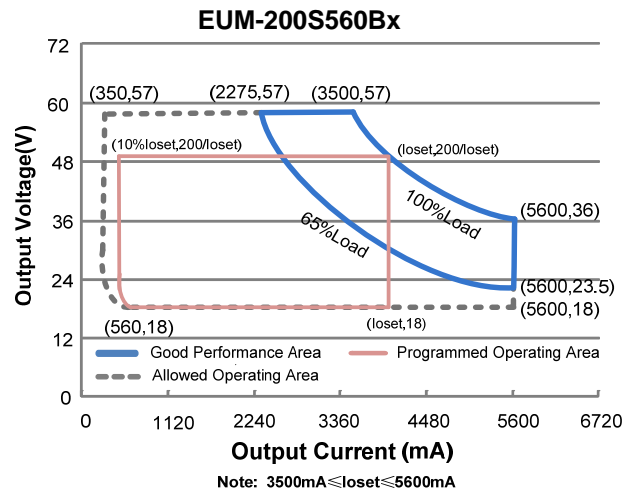
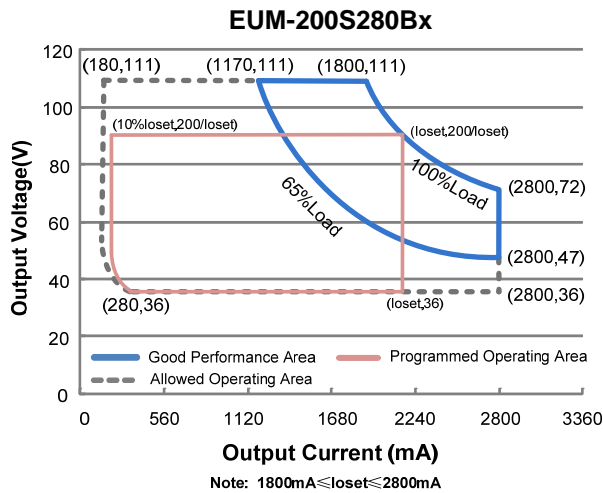
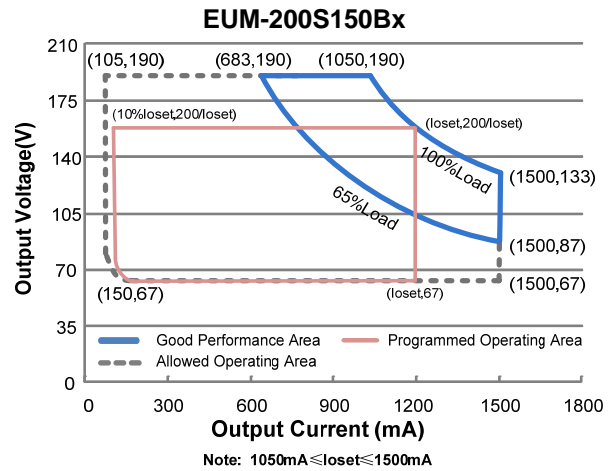
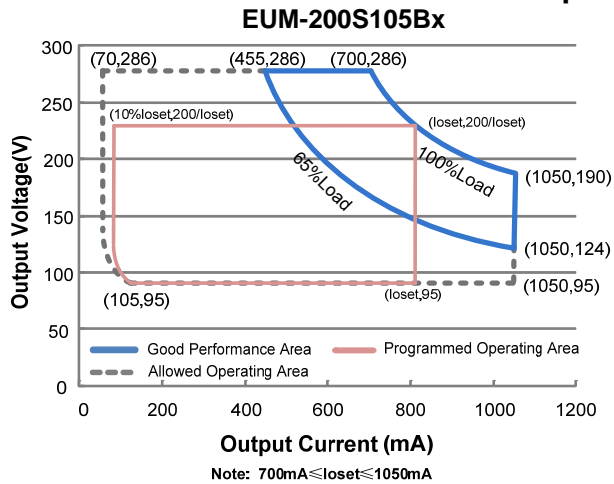

Input Specifications

Parameter	Min.	Typ.	Max.	Notes
Input AC Voltage	90 Vac	-	305 Vac	
Input DC Voltage	127 Vdc	-	300 Vdc	
Input Frequency	47 Hz	-	63 Hz	
Leakage Current	-	-	0.75 MIU	UL8750; 277Vac/60Hz
	-	-	0.70 mA	IEC60598-1; 240Vac/60Hz,
Input AC Current	-	-	2.12 A	Measured at 100%load and 120 Vac input.
	-	-	1.12 A	Measured at 100%load and 220 Vac input.
Inrush Current(I^2t)	-	-	4.65 A ² s	At 220Vac input, 25°C cold start, duration=584 μ s, 10%Ipk-10%Ipk. See Inrush Current Waveform for the details.

Input Specifications (Continued)

Parameter	Min.	Typ.	Max.	Notes
PF	0.9	-	-	At 100-277Vac, 50-60Hz, 65%-100% load (130-200W)
THD	-	-	20%	
THD	-	-	10%	At 220-240Vac, 50-60Hz, 75%-100% load (150-200W)

Output Specifications

Parameter	Min.	Typ.	Max.	Notes
Output Current Tolerance	-5%loset	-	5%loset	At 100%load condition
Output Current Setting(loset) Range				
EUM-200S105Bx	70 mA	-	1050 mA	
EUM-200S150Bx	105 mA	-	1500 mA	
EUM-200S280Bx	180 mA	-	2800 mA	
EUM-200S560Bx	350 mA	-	5600 mA	
Output Current Setting Range with Constant Power				
EUM-200S105Bx	700 mA	-	1050 mA	
EUM-200S150Bx	1050 mA	-	1500 mA	
EUM-200S280Bx	1800 mA	-	2800 mA	
EUM-200S560Bx	3500 mA	-	5600 mA	
Total Output Current Ripple (pk-pk)	-	5%lomax	10%lomax	At 100%load condition. 20 MHz BW
Output Current Ripple at < 200 Hz (pk-pk)	-	2%lomax	-	At 100%load condition. Only this component of ripple is associated with visible flicker.
Startup Overshoot Current	-	-	10%lomax	At 100%load condition
No Load Output Voltage				
EUM-200S105Bx	-	-	360 V	
EUM-200S150Bx	-	-	240 V	
EUM-200S280Bx	-	-	120 V	
EUM-200S560Bx	-	-	75 V	
Line Regulation	-	-	±0.5%	Measured at 100%load
Load Regulation	-	-	±3.0%	
Turn-on Delay Time				
	-	-	0.5 s	Measured at all dimming modes except DALI-2, and 120-277Vac input, 65%-100%Load
	-	-	1.0 s	Measured at DALI-2 dimming mode, and 120-277Vac input, 65%-100% Load
Temperature Coefficient of loset	-	0.03%/°C	-	Case temperature = 0°C~Tc max

Output Specifications (Continued)

Parameter	Min.	Typ.	Max.	Notes
24V Auxiliary Output Voltage	21.6 V	24 V	26.4 V	
24V Auxiliary Output Source Current	0 mA	-	125 mA	Return terminal is "DA"
24V Auxiliary Output Transient Peak Current@6W	-	-	250 mA	250mA peak for a maximum duration of 2.2 ms in a 6.0ms period during which time the average should not exceed 125mA.
24V Auxiliary Output Transient Peak Current@10W	-	-	425 mA	425mA peak for a maximum duration of 1.3 ms in a 5.2ms period during which time the average should not exceed 125mA.
Integrated DALI-2 Bus Power Supply Voltage	12 Vdc	16 Vdc	20 Vdc	Voltage is depending on loading.
Integrated DALI-2 Bus Power Supply Current	50 mA	-	60 mA	Return terminal is "DA"

Notes: (1) DALI-2 bus power supply is enabled by default and can be disabled via programming interface.
 (2) DALI-2 bus power supply supports automatic shut-down and restart after short-circuit.

General Specifications

Parameter	Min.	Typ.	Max.	Notes
Efficiency at 120 Vac input:				
EUM-200S105Bx				
I _o = 700 mA	88.5%	90.5%	-	
I _o =1050 mA	89.0%	91.0%	-	
EUM-200S150Bx				
I _o =1050 mA	88.5%	90.5%	-	Measured at 100%load and steady-state temperature in 25°C ambient; (Efficiency will be about 2.0% lower if measured immediately after startup.)
I _o =1500 mA	88.5%	90.5%	-	
EUM-200S280Bx				
I _o =1800 mA	88.0%	90.0%	-	
I _o =2800 mA	88.0%	90.0%	-	
EUM-200S560Bx				
I _o =3500 mA	87.0%	89.0%	-	
I _o =5600 mA	87.0%	89.0%	-	
Efficiency at 220 Vac input:				
EUM-200S105Bx				
I _o = 700 mA	91.5%	93.5%	-	Measured at 100%load and steady-state temperature in 25°C ambient; (Efficiency will be about 2.0% lower if measured immediately after startup.)
I _o =1050 mA	91.5%	93.5%	-	
EUM-200S150Bx				
I _o =1050 mA	91.5%	93.5%	-	
I _o =1500 mA	91.5%	93.5%	-	
EUM-200S280Bx				
I _o =1800 mA	91.0%	93.0%	-	
I _o =2800 mA	91.0%	93.0%	-	
EUM-200S560Bx				
I _o =3500 mA	90.0%	92.0%	-	
I _o =5600 mA	89.5%	91.5%	-	

General Specifications (Continued)

Parameter	Min.	Typ.	Max.	Notes
Efficiency at 277 Vac input: EUM-200S105Bx I _o = 700 mA I _o =1050 mA EUM-200S150Bx I _o =1050 mA I _o =1500 mA EUM-200S280Bx I _o =1800 mA I _o =2800 mA EUM-200S560Bx I _o =3500 mA I _o =5600 mA	92.0% 92.0% 92.0% 92.0% 91.5% 91.5% 90.5% 90.0%	94.0% 94.0% 94.0% 94.0% 93.5% 93.5% 92.5% 92.0%	- - - - - - - -	Measured at 100%load and steady-state temperature in 25°C ambient; (Efficiency will be about 2.0% lower if measured immediately after startup.)
Power Monitoring Accuracy	-1%	-	1%	Measured at 220Vac input and 100%Load
Standby Power	-	-	0.5 W	Measured at 230Vac/50Hz; Dimming off
MTBF	-	205,000 Hours	-	Measured at 220Vac input, 80%Load and 25°C ambient temperature (MIL-HDBK-217F)
Lifetime	-	102,000 Hours	-	Measured at 220Vac input, 80%Load and 70°C case temperature; See lifetime vs. T _c curve for the details
Operating Case Temperature for Safety T _{c_s}	-40°C	-	+90°C	
Operating Case Temperature for Warranty T _{c_w}	-40°C	-	+75°C	Case temperature for 7 years warranty Humidity: 10% RH to 95% RH;
Storage Temperature	-40°C	-	+85°C	Humidity: 5%RH to 95%RH
Dimensions Inches (L × W × H) Millimeters (L × W × H)	6.73 × 2.66 × 1.44 171 × 67.5 × 36.5			With mounting ear 7.40 × 2.66 × 1.44 188 × 67.5 × 36.5
Net Weight	-	1000 g	-	

Dimming Specifications

Parameter	Min.	Typ.	Max.	Notes	
DA+, DA- High Level	9.5 V	16 V	22.5 V		
DA+, DA- Low Level	-6.5 V	0 V	6.5 V		
DA+, DA- Current	0 mA	-	2 mA		
Dimming Output Range	EUM-200S105Bx EUM-200S150Bx EUM-200S280Bx EUM-200S560Bx	10%I _o set	-	I _o set	700 mA ≤ I _o set ≤ 1050 mA 1050 mA ≤ I _o set ≤ 1500 mA 1800 mA ≤ I _o set ≤ 2800 mA 3500 mA ≤ I _o set ≤ 5600 mA
	EUM-200S105Bx EUM-200S150Bx EUM-200S280Bx EUM-200S560Bx	70 mA 105 mA 180 mA 350 mA	-	I _o set	70 mA ≤ I _o set < 700 mA 105 mA ≤ I _o set < 1050 mA 180 mA ≤ I _o set < 1800 mA 350 mA ≤ I _o set < 3500 mA

Safety & EMC Compliance

Safety Category	Standard
UL/CUL	UL8750,CAN/CSA-C22.2 No. 250.13
ENEC & CE	EN 61347-1, EN61347-2-13
CB	IEC 61347-1, IEC 61347-2-13
CCC	GB 19510.1, GB 19510.14
PSE	J 61347-1, J 61347-2-13
BIS	IS 15885(Part2/Sec13)
Global Mark	AS/NZS 61347.1, AS/NZS 61347.2.13
KS	KS C 7655
EMI Standards	Notes
EN 55015/GB 17743/KN 15 ⁽¹⁾	Conducted emission Test & Radiated emission Test
EN 61000-3-2/GB 17625.1	Harmonic current emissions
EN 61000-3-3	Voltage fluctuations & flicker
FCC Part 15 ⁽¹⁾	ANSI C63.4 Class B
	This device complies with Part 15 of the FCC Rules. Operation is subject to the following two conditions: [1] this device may not cause harmful interference, and [2] this device must accept any interference received, including interference that may cause undesired operation.
EMS Standards	Notes
EN 61000-4-2	Electrostatic Discharge (ESD): 8 kV air discharge, 4 kV contact discharge
EN 61000-4-3	Radio-Frequency Electromagnetic Field Susceptibility Test-RS
EN 61000-4-4	Electrical Fast Transient / Burst-EFT: level 3, criteria A
EN 61000-4-5	Surge Immunity Test: AC Power Line: line to line 6 kV, line to earth 10 kV
EN 61000-4-6	Conducted Radio Frequency Disturbances Test-CS
EN 61000-4-8	Power Frequency Magnetic Field Test
EN 61000-4-11	Voltage Dips
EN 61547	Electromagnetic Immunity Requirements Applies To Lighting Equipment
DALI-2 Standards	Notes
DALI-2 ⁽²⁾	IEC 62386-101, -102 & -207

Notes: (1) This LED driver meets the EMI specifications above, but EMI performance of a luminaire that contains it depends also on the other devices connected to the driver and on the fixture itself.

(2) DALI parts: 101, 102, 150, 207, 250, 251, 252, 253.

Derating

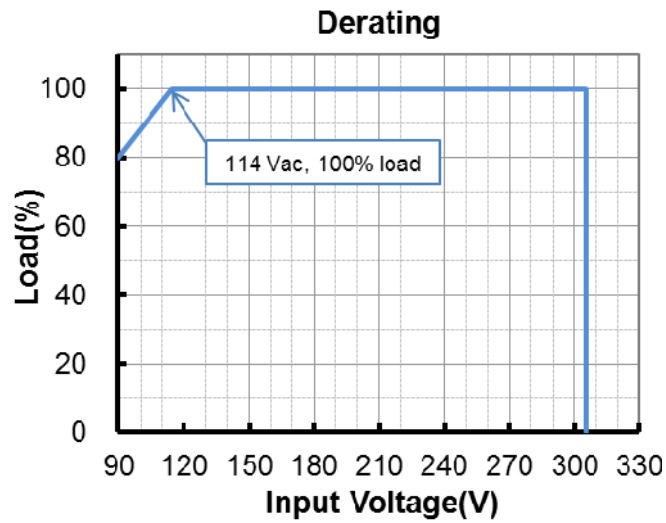

Lifetime vs. Case Temperature

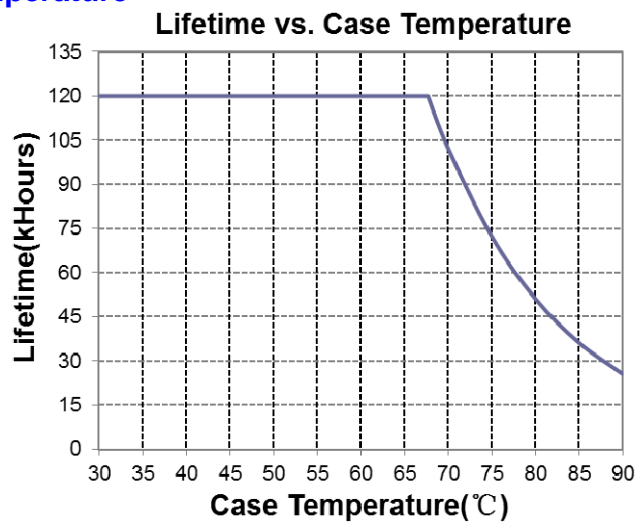

Inrush Current Waveform

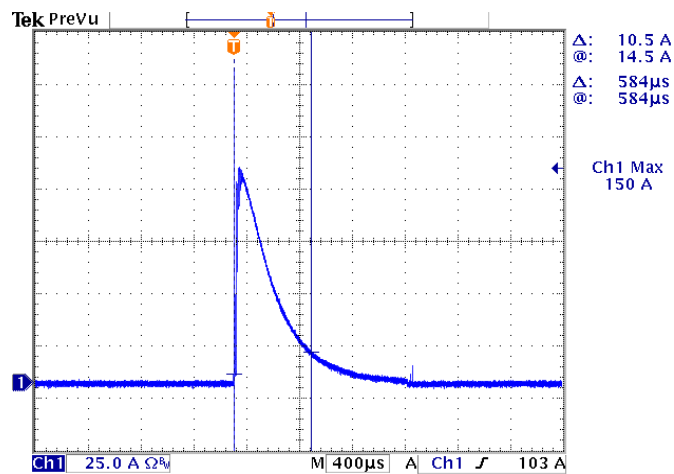

Efficiency vs. Load

EUM-200S105Bx ($I_o=700mA$)
Efficiency vs. Output Voltage

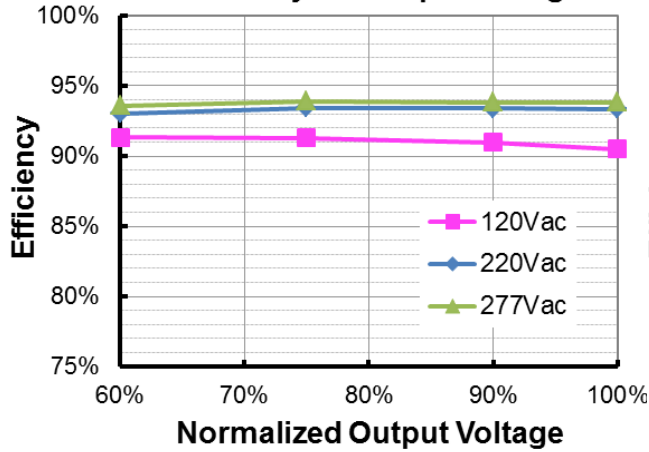

EUM-200S105Bx ($I_o=1050mA$)
Efficiency vs. Output Voltage

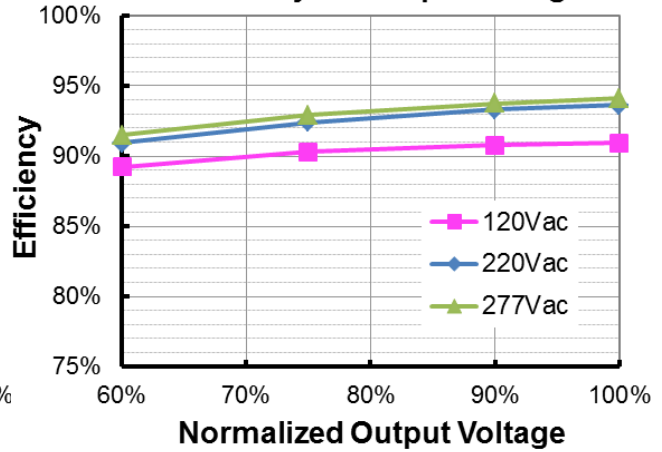

EUM-200S150Bx ($I_o=1050mA$)
Efficiency vs. Output Voltage

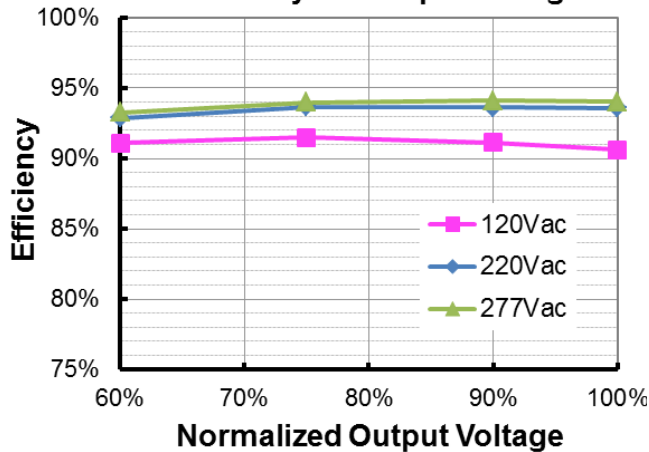

EUM-200S150Bx ($I_o=1500mA$)
Efficiency vs. Output Voltage

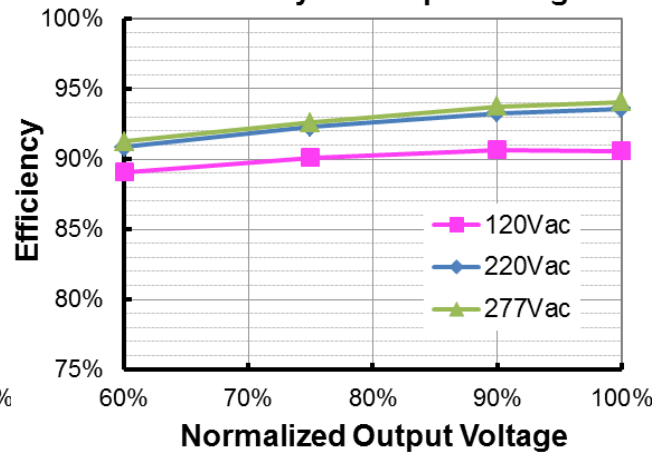

EUM-200S280Bx ($I_o=1800mA$)
Efficiency vs. Output Voltage

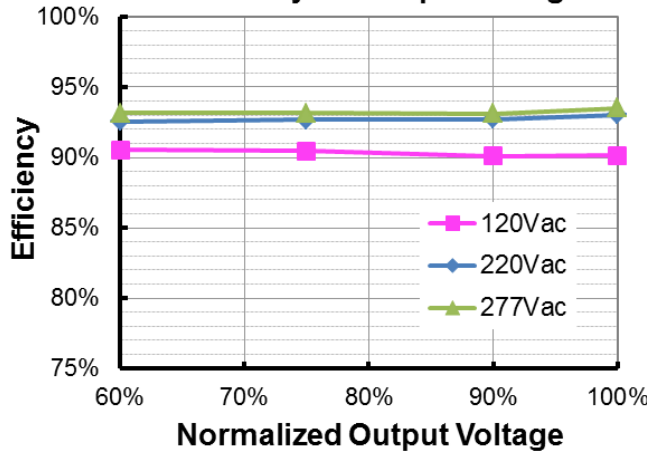

EUM-200S280Bx ($I_o=2800mA$)
Efficiency vs. Output Voltage

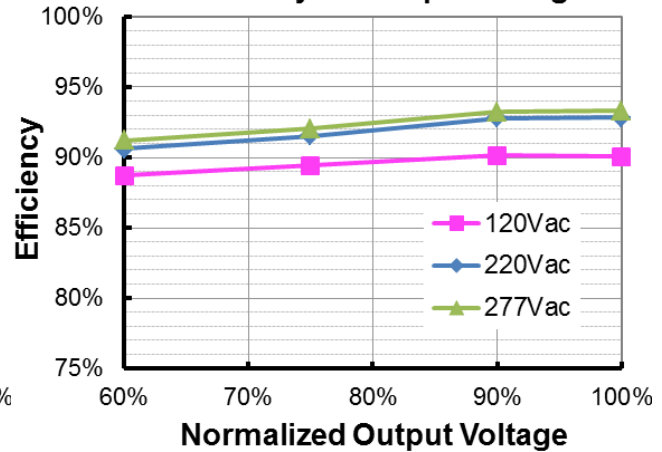

EUM-200S560Bx($I_o=3500mA$)
Efficiency vs. Output Voltage

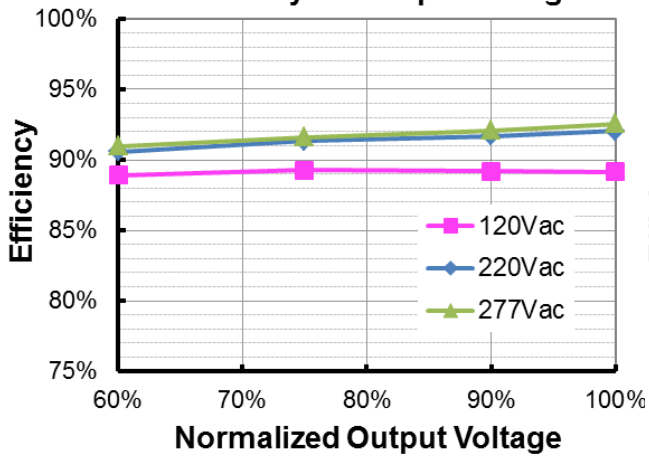

EUM-200S560Bx($I_o=5600mA$)
Efficiency vs. Output Voltage

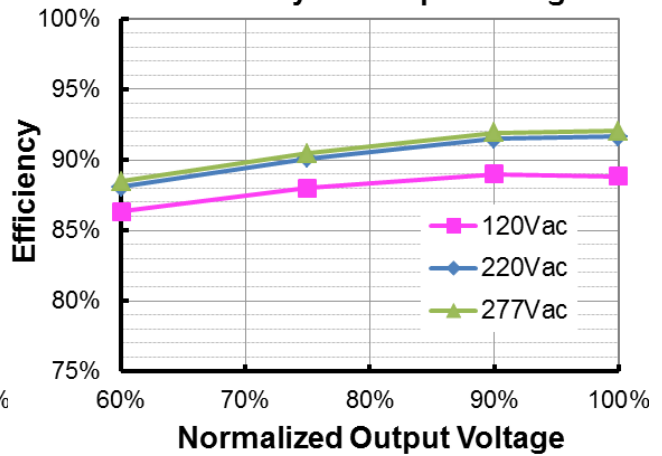

Power Factor

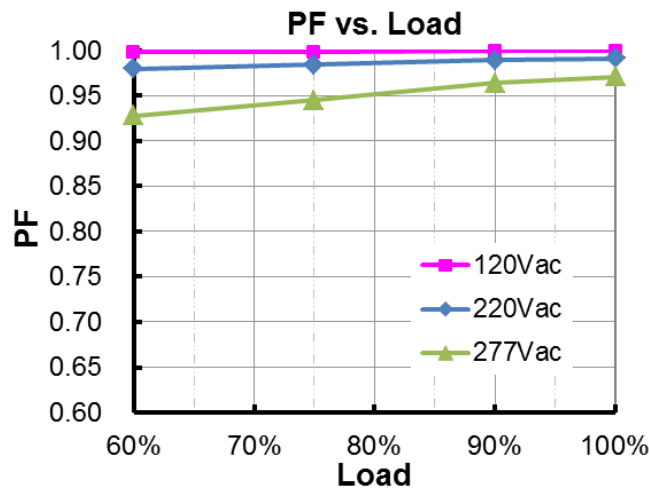

Total Harmonic Distortion

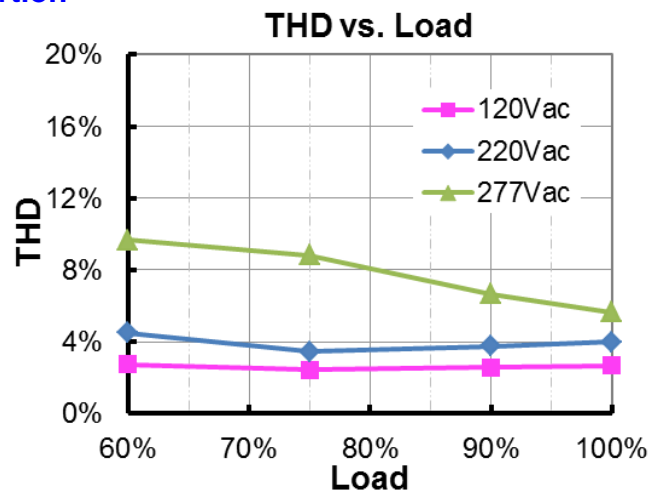

Protection Functions

Parameter		Min.	Typ.	Max.	Notes
External Thermal Protection	R1 (Start derating)	-	1.67 kΩ	-	The output current starts to decrease linearly when the actual NTC resistance value is lower than R1, until R2 is reached.
	R2 (Stop derating)	-	1.27 kΩ	-	When the actual NTC resistance value is lower than R2, the output current will stay at the programmed Protection Current Floor.
	Protection Current Floor	10%loset	20%loset	100%loset	10%loset > I _{omin} (default setting is 20%)
I _{omin}		20%loset	100%loset	10%loset ≤ I _{omin} (default setting is 20%)	
Over Voltage Protection		Limits output voltage at no load and in case the normal voltage limit fails.			
Short Circuit Protection		Auto Recovery. No damage will occur when any output is short circuited. The output shall return to normal when the fault condition is removed.			
Over Temperature Protection		Decreases output current, returning to normal after over temperature is removed.			
Input Under Voltage Protection (IUVP)	Input Under Voltage Protection	70 Vac	80 Vac	90 Vac	Turn off the output when the input voltage falls below protection voltage.
	Input Under Voltage Recovery	75 Vac	85 Vac	95 Vac	Auto Recovery. The driver will restart when the input voltage exceeds recovery voltage.
Input Over Voltage Protection	Input Over Voltage Protection	310 Vac	320 Vac	330 Vac	Turn off the output when the input voltage exceeds protection voltage.
	Input Over Voltage Recovery	300 Vac	310 Vac	320 Vac	Auto Recovery. The driver will restart when the input voltage falls below recovery voltage.
	Max. of Input Over Voltage	-	-	350 Vac	The driver can survive stabilized input over voltage conditions up to 350Vac for a total of 8 hours.

Note: (1) The recommended NTC type is 10kΩ NTC, Murata NCP18XH103J03RB.

● Input Under Voltage Protection Diagram

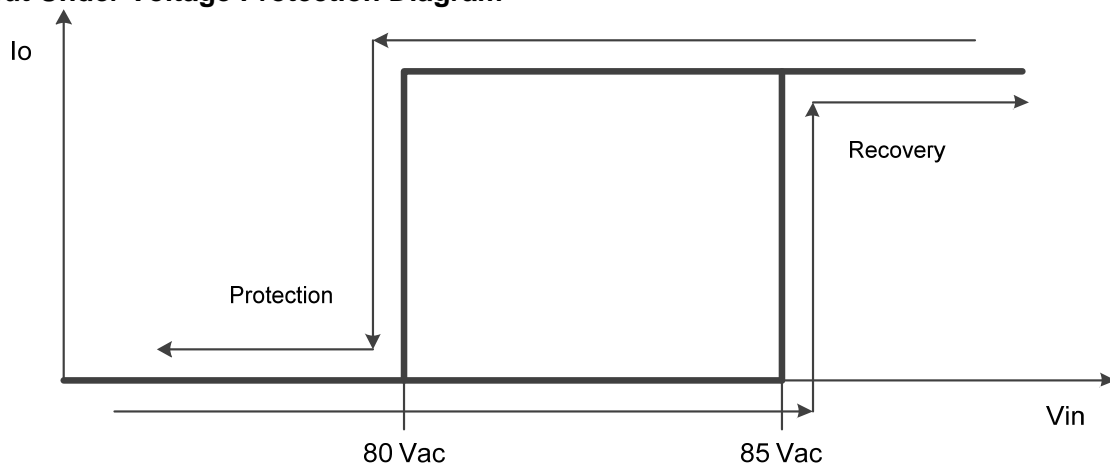

● **Input Over Voltage Protection Diagram**

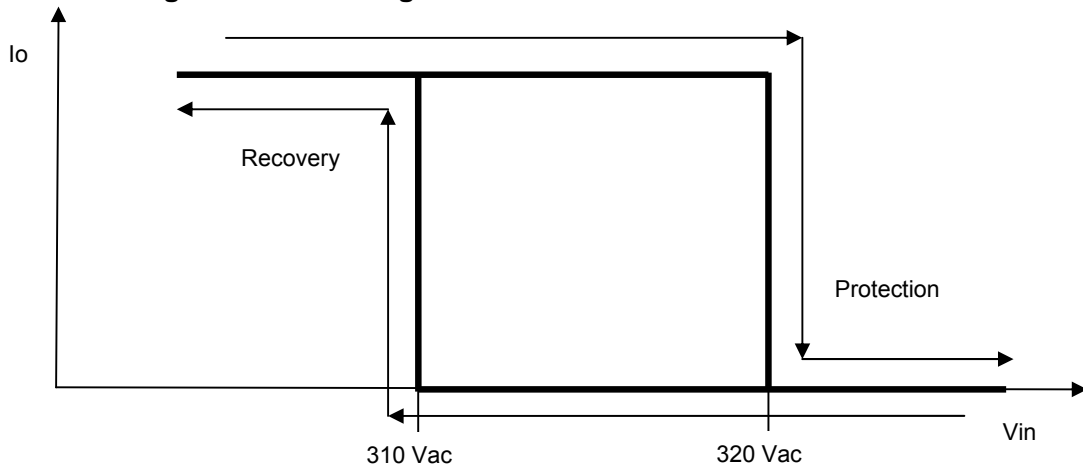

Dimming

● **DALI-2 Dimming**

The recommended implementation of the dimming control is provided below.

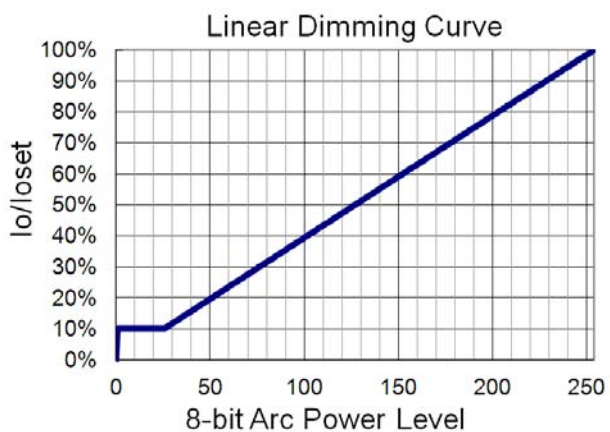
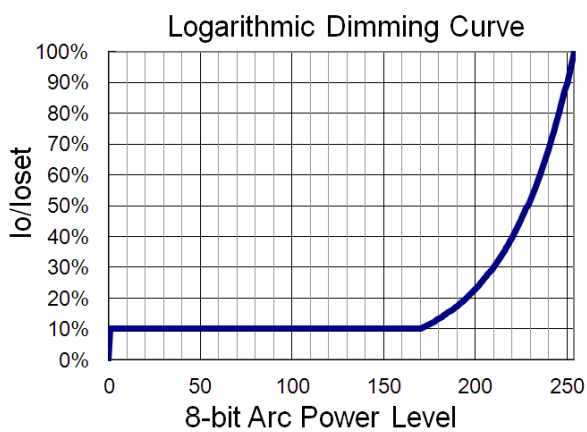
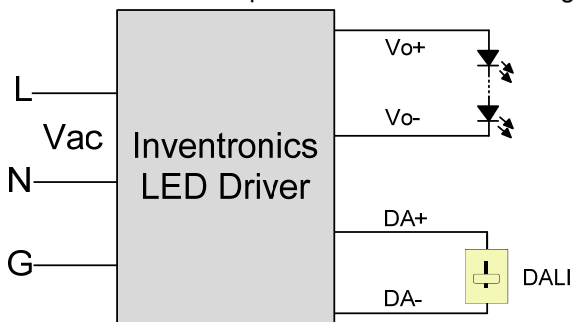

Implementation: DALI-2 Dimming

● Time Dimming

Time dimming control includes 3 kinds of modes, they are Self Adapting-Midnight, Self Adapting-Percentage and Traditional Timer.

- **Self Adapting-Midnight:** Automatically adjusts the dimming curve based on the on-time of past two days (if difference <15 minutes), assuming that the center point of the dimming curve is midnight local time.
- **Self Adapting-Percentage:** Automatically adjusts the on-time of each step by a constant percentage = (actual on-time for the past 2 days if difference <15 min) / (programmed on-time from the dimming curve).
- **Traditional Timer:** Follows the programmed timing curve after power on with no changes.

● Output Lumen Compensation

Output Lumen Compensation (OLC) may be used to maintain constant light output over the life of the LEDs by driving them at a reduced current when new, then gradually increasing the drive current over time to counteract LED lumen degradation.

● End Of Life

End-of-Life (EOL) is providing a visual notification to a user that the LED module has reached the end of manufacturer-specified life and that the replacement is recommended. Once active, an indication is given at each power-up of the driver, which the driver indicates this through a lower light output during the first 1 minute before normal operation is continued.

Programming Connection Diagram

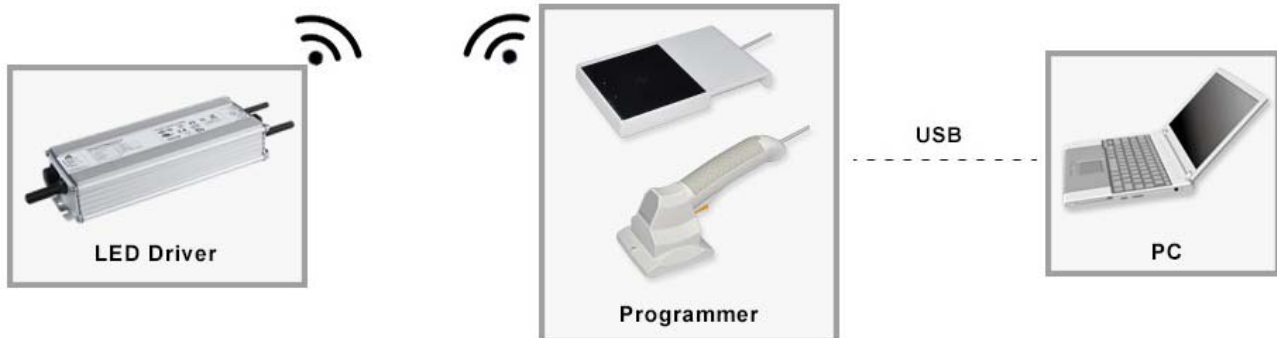

Note: The driver does not need to be powered on during the programming process.

- Please refer to [PRG-NFC-H](#) or [PRG-NFC-D](#) (Programmer) datasheet for details.

Mechanical Outline

EUM-200SxxxBG

INPUT(UL SJOW 17AWG/3C & VDE H05RN-F 3*1.0mm² Ø 8.3)

Dimming Wire(UL21996 22AWG/3C Ø 5.0)

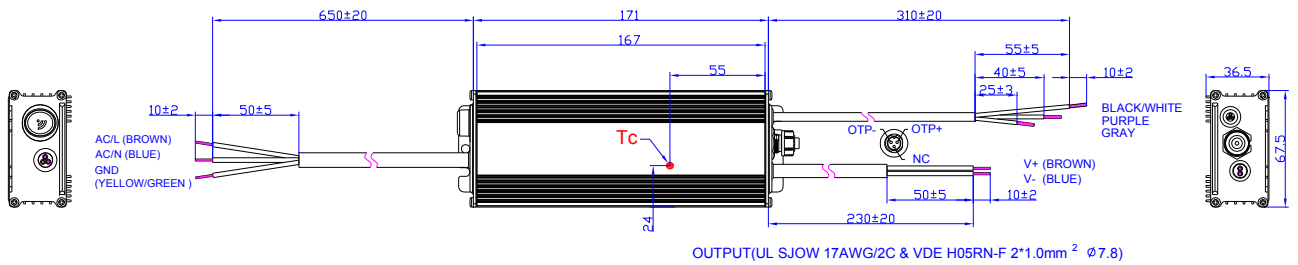

OUTPUT(UL SJOW 17AWG/2C & VDE H05RN-F 2*1.0mm² Ø 7.8)

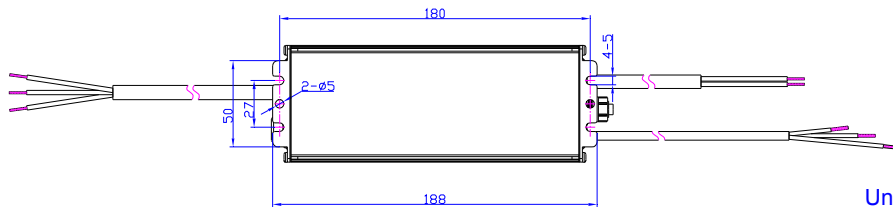
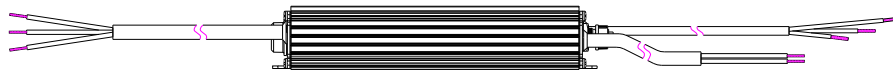

Unspecified tolerance:±1

EUM-200SxxxBT

INPUT(UL SJTW 18AWG/3C Ø 7.8)

Dimming Wire(UL21996 22AWG/3C Ø 5.0)

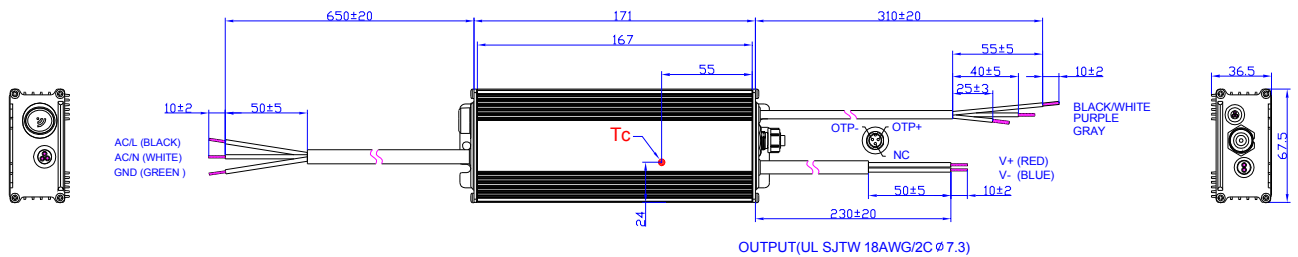

OUTPUT(UL SJTW 18AWG/2C Ø 7.3)

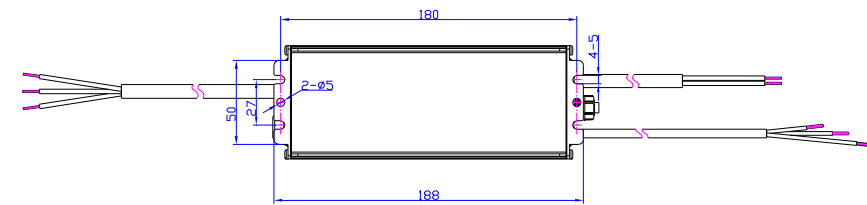
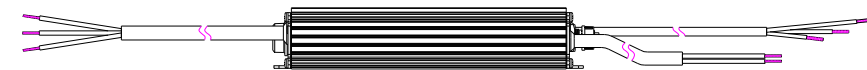

Unspecified tolerance:±1

EUM-200SxxxBB

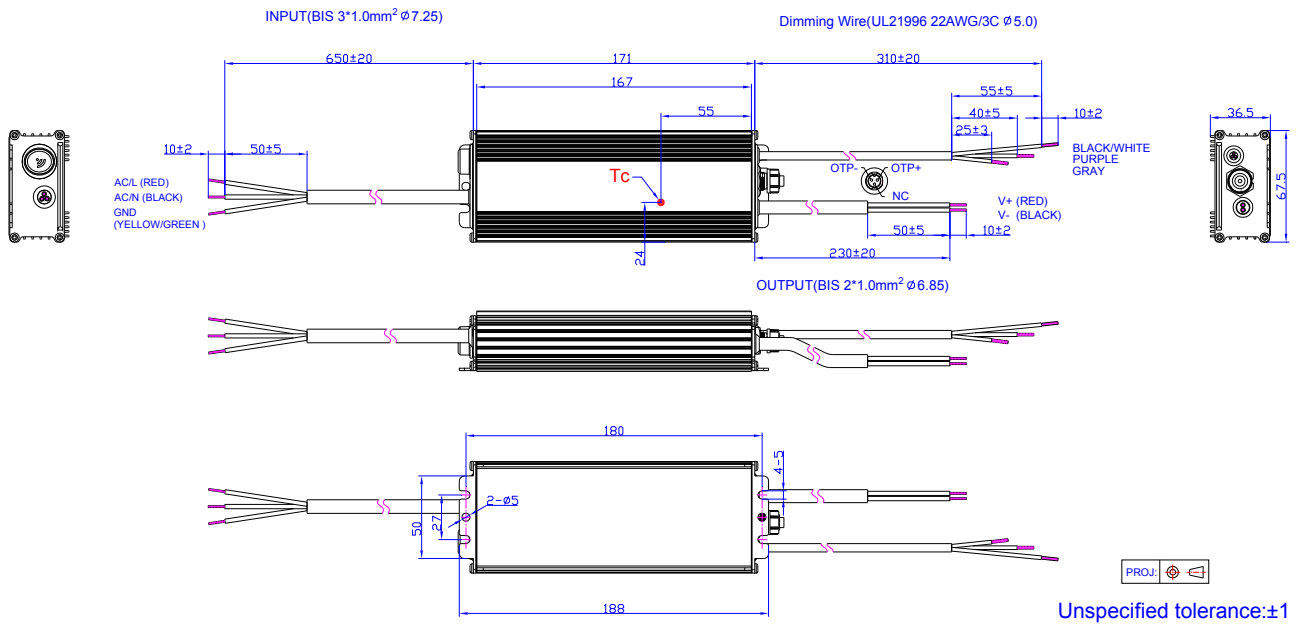

RoHS Compliance

Our products comply with reference to RoHS Directive (EU) 2015/863 amending 2011/65/EU, calling for the elimination of lead and other hazardous substances from electronic products.

Revision History

Change Date	Rev.	Description of Change		
		Item	From	To
2020-08-04	A	Datasheet Release	/	/