

## 50 & 30 W Programmable CC Class 2 LED Driver with Integrated Bluetooth® Mesh

Nominal Input Voltage	Max. Output Power	Output Current	Efficiency	Max. Case Temperature	THD	Power Factor	Dimming Method	Dimming Range	Startup Time
120 & 277 Vac	50 W	300 mA to 1200 mA	up to 90% typical	90°C (measured at the hot spot)	< 20%	> 0.9	Bluetooth	1 - 100%	300 ms typical

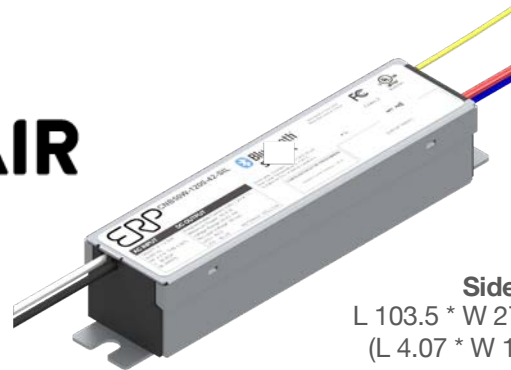
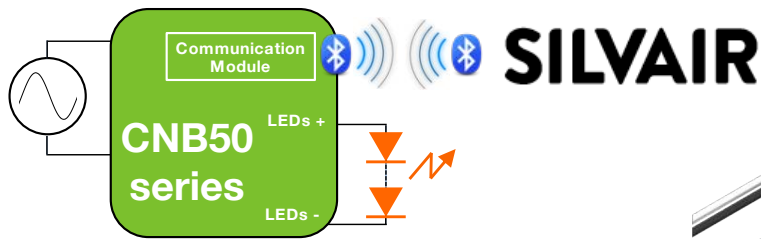

**Side Leads**  
L 103.5 \* W 27.3 \* H 22.65 mm  
(L 4.07 \* W 1.07 \* H 0.89 in.)

### FEATURES

- UL Class P
- Class 2 power supply
- Lifetime: 50,000 hours @ Tc ≤ 75°C
- 90°C maximum case hot spot temperature
- IP20-rated case with silicone-based potting
- Surge protection:
  - IEC61000-4-5: 2 kV line to line/2 kV line to earth
  - 2.5 kV ring wave: ANSI/IEEE c62.41.1-2002 & c62.41.2-2002 category A
- Complies with ENERGY STAR®, DLC (DesignLight Consortium®) and CA Title 24 technical requirements

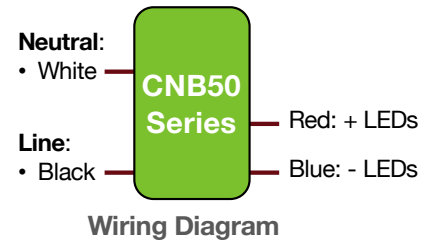

### NFC PROGRAMMING

- Current: 100% to 50% in each voltage range
- Data log read: SKU, S/N, lot code, hours of operation, FW rev., power cycles

### APPLICATIONS

- Commercial lighting
- Architectural lighting
- Indoor lighting



## 50 & 30 W Programmable CC Class 2 LED Driver with Integrated Bluetooth® Mesh

### 1 - ORDERING INFORMATION

Part Number	Nominal Input Voltage (Vac)	Max Output Power (W)	Iout (mA)	Vout Min. (Vdc)	Vout Nom. (Vdc)	Vout Max. (Vdc)	Open Loop (No Load) Voltage (Vdc)	Comments
<b>120 &amp; 277 VAC NOMINAL INPUT VOLTAGE</b>								
<b>CNB30W</b>								
CNB30W-0600-42-SILF	120 & 277	25.2	300 to 600	28	37.8	42	50	Rigado BMD-300/1 Bluetooth Mesh module with Silvair Bluetooth firmware, with wire whip antenna, Side Leads case
<b>CNB50W</b>								
CNB50W-1200-42-SILF	120 & 277	50.4	600 to 1200	28	37.8	42	50	Rigado BMD-300/1 Bluetooth Mesh module with Silvair software, with wire whip antenna, Side Leads case

## 50 & 30 W Programmable CC Class 2 LED Driver with Integrated Bluetooth® Mesh

### 2 - INPUT SPECIFICATION (@25°C ambient temperature)

	Units	Minimum	Typical	Maximum	Notes
<b>Input Voltage Range (Vin)</b>	Vac	90	120 & 277	305	<ul style="list-style-type: none"> <li>The rated output current for each model is achieved at <math>V_{in} \geq 108</math> Vac &amp; at <math>V_{in} \geq 198</math> Vac</li> <li>At nominal load</li> </ul>
<b>Input Frequency Range</b>	Hz	47	60	63	
<b>Input Current (Iin)</b>	A			0.5 A @ 120 Vac 0.23 A @ 277 Vac	
<b>Power Factor (PF)</b>		0.9	> 0.9		<ul style="list-style-type: none"> <li>At nominal input voltage and with nominal LED voltage</li> <li>From 100% to 50% of rated power</li> </ul>
<b>Inrush Current</b>	A	Meets NEMA-410 requirements			<ul style="list-style-type: none"> <li>At any point on the sine wave and 25°C</li> <li>Active limiting inrush current is available as an option. Please contact your ERP representative or send an email to SaveEnergy@erp-power.com.</li> </ul>
<b>Leakage Current</b>	mA			0.3 mA @ 120 Vac 0.7 mA @ 277 Vac	Measured per IEC60950-1
<b>Input Harmonics</b>	Complies with IEC61000-3-2 for Class C equipment				
<b>Total Harmonics Distortion (THD)</b>				20%	<ul style="list-style-type: none"> <li>At nominal input voltage and nominal LED voltage</li> <li>From 100% to 50% of rated power</li> <li>Complies with DLC (Design Light Consortium) technical requirements</li> </ul>
<b>Efficiency</b>	%	-	up to 90%	-	Measured with nominal input voltage, a full sinusoidal wave form and without dimmer attached.
<b>Isolation</b>	The AC input to the main DC output is isolated				

### 3 - MAIN OUTPUT SPECIFICATION (@25°C ambient temperature)

	Units	Minimum	Typical	Maximum	Notes
<b>Output Voltage (Vout)</b>	Vdc				See ordering information for details
<b>Output Current (Iout)</b>	mA				<ul style="list-style-type: none"> <li>See ordering information for details</li> <li>The rated output current for each model is achieved at <math>V_{in} \geq 108</math> Vac &amp; at <math>V_{in} \geq 198</math> Vac.</li> </ul>
<b>Output Current Regulation</b>	%	-5	$\pm 2.5$	5	<ul style="list-style-type: none"> <li>At nominal AC line voltage</li> <li>Includes load and current set point variations</li> </ul>
<b>Output Current Overshoot</b>	%	-	-	10	The driver does not operate outside of the regulation requirements for more than 500 ms during power on with nominal LED load and without dimmer.
<b>Ripple Current</b>	$\leq 10\%$ of rated output current for each model				<ul style="list-style-type: none"> <li>Measured at nominal LED voltage and nominal input voltage without dimming</li> <li>Calculated in accordance with the IES Lighting Handbook, 9th edition</li> </ul>
<b>Dimming Range (% of Iout)</b>	%	1		100	<ul style="list-style-type: none"> <li>Dimming is controlled by Bluetooth mesh from 1% to 100%.</li> <li>Dimming performance is optimal when the driver is operated at its nominal output voltage matching the LED nominal Vf (forward voltage). Dimming performance may vary when the driver is operated near its minimum output voltage.</li> </ul>
<b>Start-up Time</b>	ms		300	500	<ul style="list-style-type: none"> <li>Without any dimmer attached, and at nominal input voltages and nominal load</li> <li>Measured from application of AC line voltage to 100% light output</li> <li>Complies with ENERGY STAR® luminaire specification and CA Title 24</li> </ul>
<b>Isolation</b>	The main DC output is certified and tested per UL8750 Class 2 or LED Class 2				

## 50 & 30 W Programmable CC Class 2 LED Driver with Integrated Bluetooth® Mesh

### 4 – BLUETOOTH DIMMING CONTROL

Dimming is controlled by Bluetooth mesh from 1% to 100%.

### 5 - ENVIRONMENTAL CONDITIONS

	Units	Minimum	Typical	Maximum	Notes
<b>Operating Ambient Temperature (Ta)</b>	°C	-20		50	50°C is the non-derated temperature (Refer to section 8 "Output power de-rating at higher temperatures".
<b>Maximum Case Temperature (Tc)</b>	°C			+90	Case temperature measured at the hot spot •tc (see label in page 12)
<b>Storage Temperature</b>	°C	-40		+85	
<b>Humidity</b>	%	5	-	95	Non-condensing
<b>Cooling</b>	Convection cooled				
<b>Acoustic Noise</b>	dBA			24	Measured at a distance of 1 meter, without dimmer
<b>Mechanical Shock Protection</b>	per EN60068-2-27				
<b>Vibration Protection</b>	per EN60068-2-6 & EN60068-2-64				
<b>MTBF</b>	> 200,000 hours when operated at nominal input and output conditions, and at Tc ≤ 75°C				
<b>Lifetime</b>	50,000 hours at Tc ≤ 75°C maximum case hot spot temperature (see hot spot •tc on label in page 12)				

### 6 - EMC COMPLIANCE AND SAFETY APPROVALS

EMC Compliance					
<b>Conducted and Radiated EMI</b>	Compliant with FCC CFR Title 47 Part 15 Class B at 120 Vac & Class A at 277 Vac				
<b>Harmonic Current Emissions</b>	IEC61000-3-2	For Class C equipment			
<b>Voltage Fluctuations &amp; Flicker</b>	IEC61000-3-3				
<b>Immunity Compliance</b>	<b>ESD (Electrostatic Discharge)</b>	IEC61000-4-2	6 kV contact discharge, 8 kV air discharge, level 3		
	<b>RF Electromagnetic Field Susceptibility</b>	IEC61000-4-3	3 V/m, 80 - 1000 MHz, 80% modulated at a distance of 3 meters		
	<b>Electrical Fast Transient</b>	IEC61000-4-4	± 2 kV on AC power port for 1 minute, ±1 kV on signal/control lines		
	<b>Surge</b>	IEC61000-4-5	± 2 kV line to line (differential mode) / ± 2 kV line to common mode ground (tested to secondary ground) on AC power port, ±0.5 kV for outdoor cables		
			ANSI/IEEE c62.41.1-2002 & c62.41.2-2002 category A, 2.5 kV ring wave		
<b>Conducted RF Disturbances</b>	IEC61000-4-6	3V, 0.15-80 MHz, 80% modulated			
<b>Voltage Dips</b>	IEC61000-4-11	>95% dip, 0.5 period; 30% dip, 25 periods; 95% reduction, 250 periods			
Safety Agency Approvals					
<b>cUL</b>	UL8750 listed Class 2				
Safety					
	Units	Minimum	Typical	Maximum	Notes
<b>Hi Pot (High Potential) or Dielectric voltage-withstand</b>	Vdc	2500			<ul style="list-style-type: none"> <li>•Insulation between the input (AC line and Neutral) and the output</li> <li>•Tested at the RMS voltage equivalent of 1768 Vac</li> </ul>

## 50 & 30 W Programmable CC Class 2 LED Driver with Integrated Bluetooth® Mesh

### ■ 7 - PROTECTION FEATURES

#### **Input Over Current Protection**

The CNB series incorporates a primary AC line fuse for input over current protection to prevent damage to the LED driver and meet product safety requirements as outlined in Section 6.

#### **Short Circuit and Over Current Protection**

The CNB50/30 series is protected against short-circuit such that a short from any output to return shall not result in a fire hazard or shock hazard. The driver shall hiccup as a result of a short circuit or over current fault. Removal of the fault will return the driver to within normal operation. The driver shall recover, with no damage, from a short across the output for an indefinite period of time.

#### **Internal Over temperature Protection**

The CNB50/30 series is equipped with internal temperature sensor on the primary power train. Failure to stay within the convection power rating will result in the power supply reducing the available current (fold back) below the programmed amount. The main output current will be restored to the programmed value when the temperature of the built-in temperature sensor cools adequately.

#### **Output Open Load Protection**

When the LED load is removed, the output voltage of the CNB50/30 series is typically limited to 1.3 times the maximum output voltage of each model.

### ■ 8 - OUTPUT POWER DE-RATING AT ELEVATED TEMPERATURES

The CNB50/30 series can be operated with cooling air temperatures above 40°C by linearly de-rating the total maximum output power (or current) by 2.5%/°C typical until internal over temperature protection activates.

## 50 & 30 W Programmable CC Class 2 LED Driver with Integrated Bluetooth® Mesh

### ■ 9 - PROGRAMMING

The CNB series can be programmed by placing the programming wand over the NFC receiver area of the driver and by plugging the USB other end of the wand into a computer. ***The driver does not need to be powered on during the programming process.***

When ordering the CNB series, please make sure you order a programming wand. The part number for the programming wand is “NFC\_WAND”.

Programming is done by using the ERP GUI (Graphical User Interface), which enables the user to adjust output current from 100% to 50%.

Please note that, for each model, the **default output current setting is 50% of max current**. For example, the default output current setting for the CNB50W-1200-42 is 600 mA.

Furthermore, when programming the driver with a computer using the programming wand, you can access the driver’s internal data log and read the following information: SKU, serial number, manufacturing lot code, hours of operation, firmware revision, and power cycles.

For more information, please refer to the GUI user’s manual at:  
<https://www.erp-power.com/our-products/programming-software/>



**Figure 1**

## 50 & 30 W Programmable CC Class 2 LED Driver with Integrated Bluetooth® Mesh

### 10 - PREDICTED LIFETIME VERSUS CASE AND AMBIENT TEMPERATURE

Lifetime is defined by the measurement of the temperatures of all the electrolytic capacitors whose failure would affect light output under the nominal LED load and worst case AC line voltage. The graphs in figures 2 and 3 are determined by the electrolytic capacitor with the shortest lifetime, among all electrolytic capacitors. It represents a worst case scenario in which the LED driver is powered 24 hours/day, 7 days/week. The lifetime of an electrolytic capacitor is measured when any of the following changes in performance are observed:

- 1) Capacitance changes more than 20% of initial value
- 2) Dissipation Factor ( $\tan \delta$ ): 150% or less of initial specified value
- 3) Equivalent Series Resistance (ESR): 150% or less of initial specified value
- 4) Leakage current: less of initial specified value

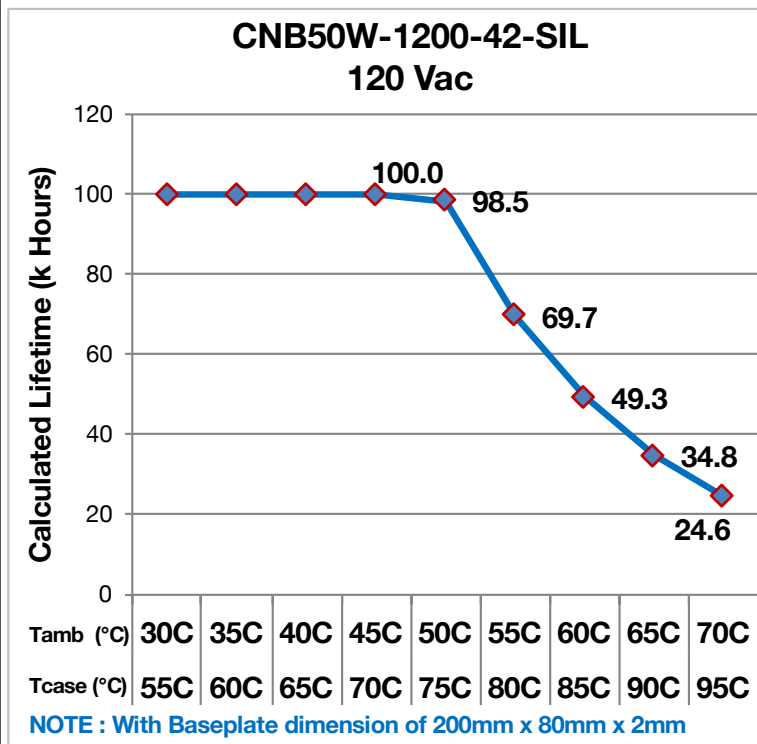

Figure 2

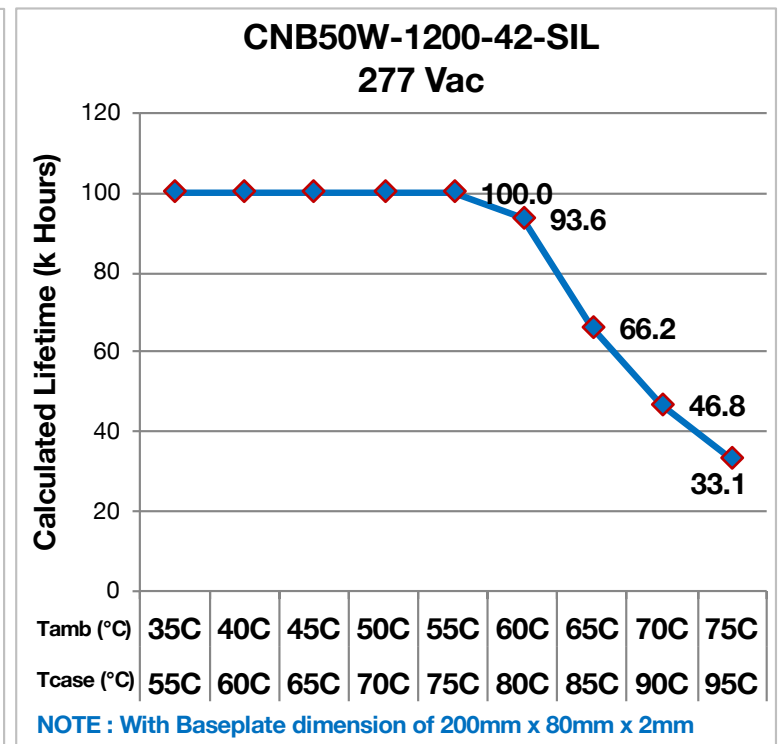

Figure 3

- Notes:
- The ambient temperature  $T_{ambient}$  and the differential between  $T_{ambient}$  and  $T_{case}$  mentioned in the above graphs are relevant only as long as both the driver and the light fixture are exposed to the same ambient room temperature. If the LED driver is housed in an enclosure or covered by insulation material, then the ambient room temperature is no longer valid. In this situation, please refer only to the case temperature  $T_{case}$ .
  - It should be noted the graph "Lifetime vs. Ambient Temperature" may have an error induced in the final application if the mounting has restricted convection flow around the case. For applications where this is evident, the actual case temperature measured at the Tc point in the application should be used for reliability calculations.

## 50 & 30 W Programmable CC Class 2 LED Driver with Integrated Bluetooth® Mesh

### 11 – EFFICIENCY VERSUS LOAD

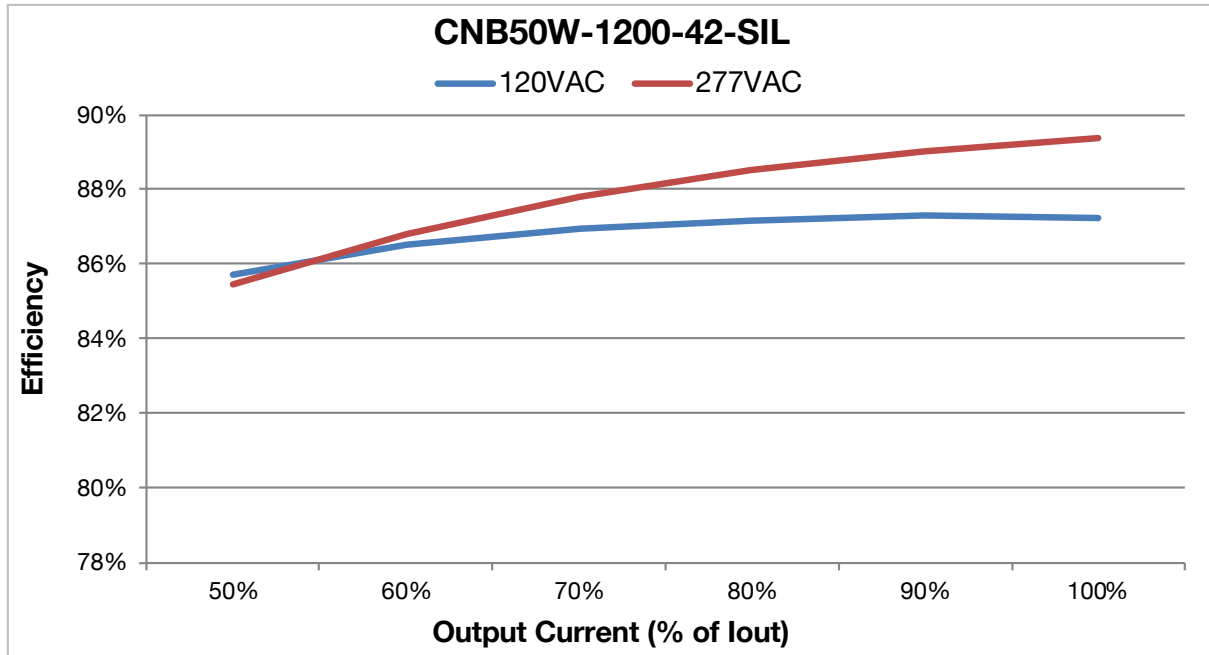

Figure 4

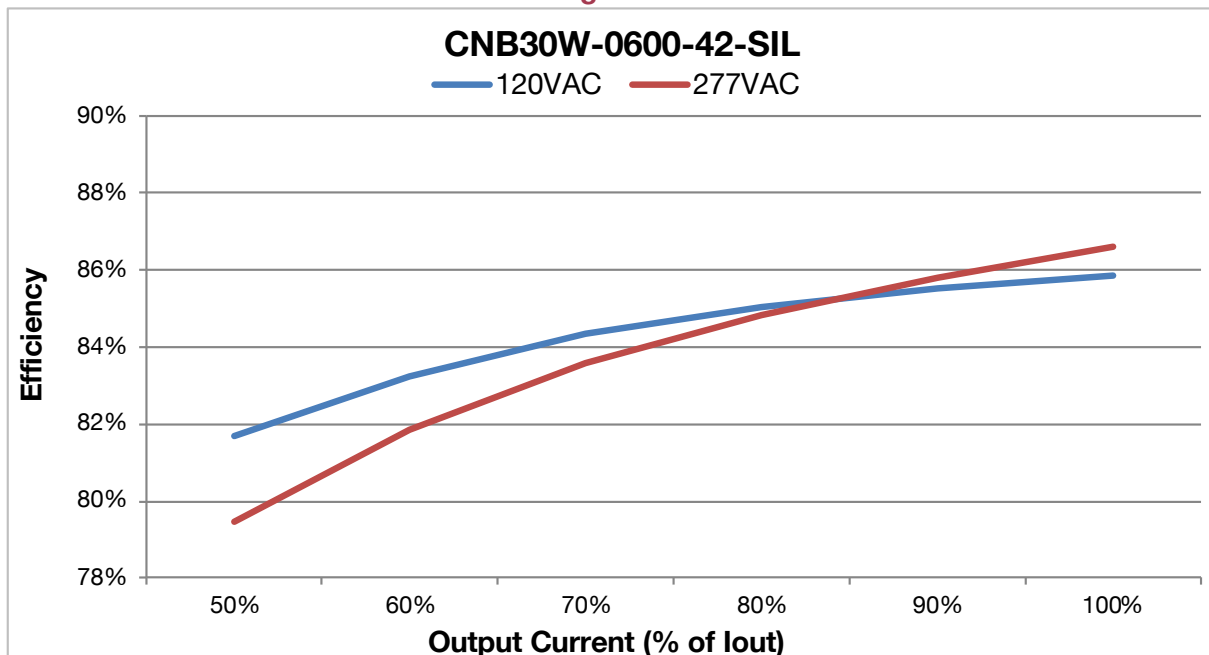

Figure 5



## 50 & 30 W Programmable CC Class 2 LED Driver with Integrated Bluetooth® Mesh

12 – POWER FACTOR VERSUS LOAD

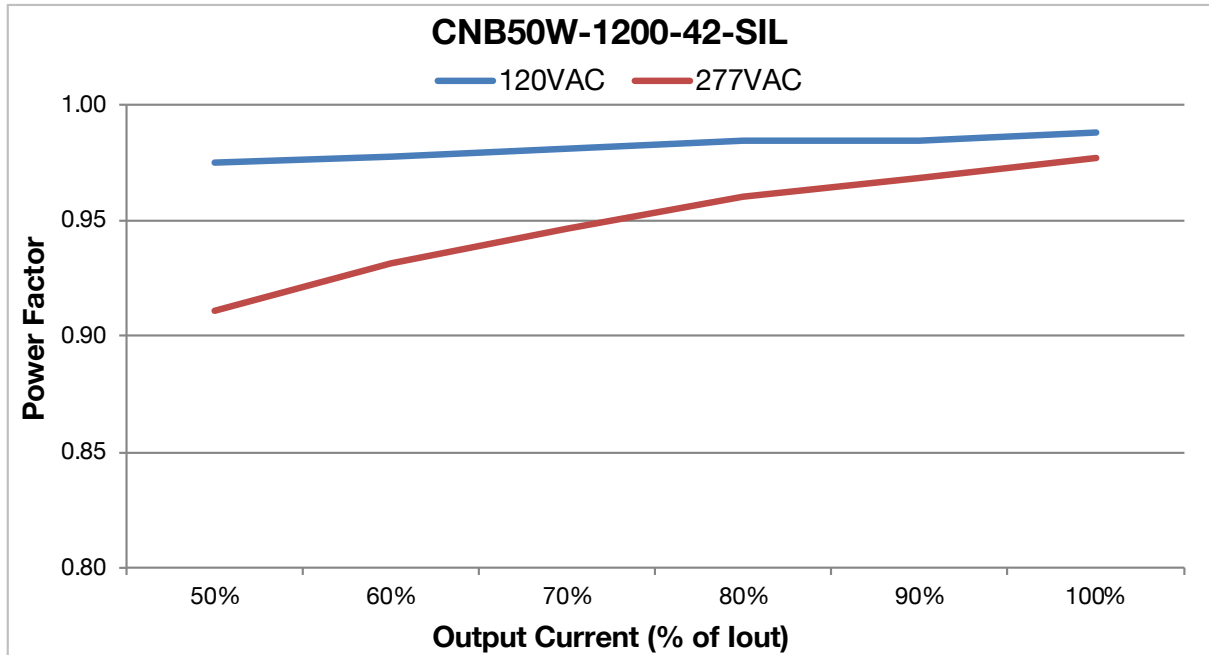

Figure 6

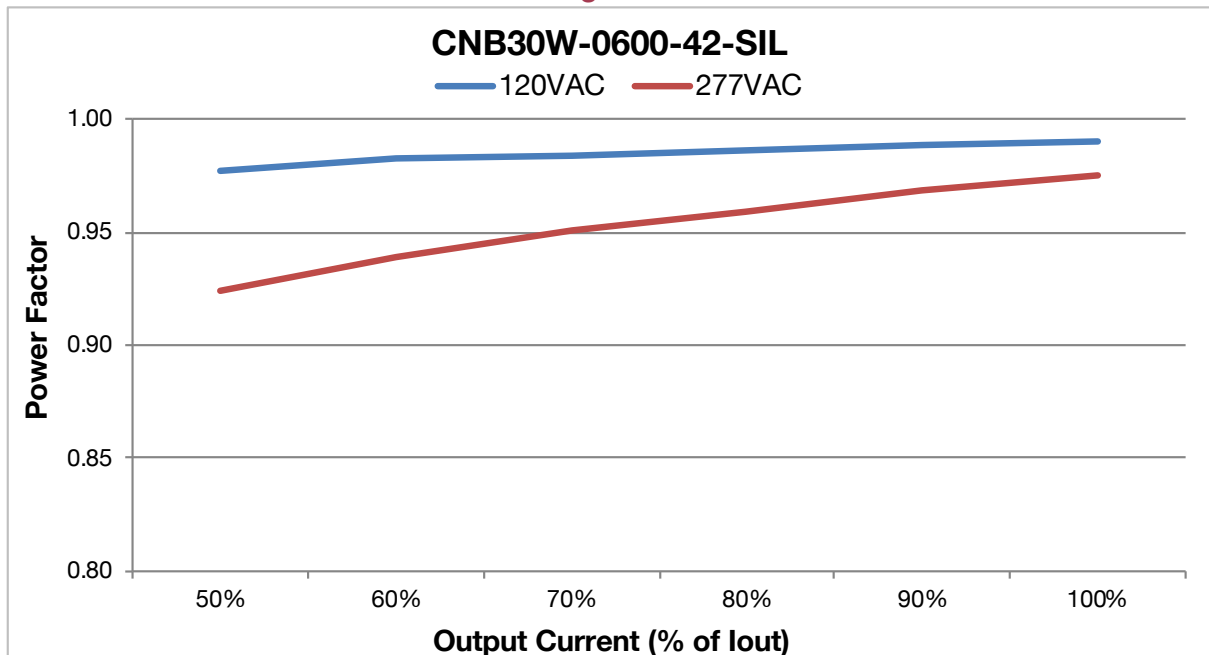

Figure 7

## 50 & 30 W Programmable CC Class 2 LED Driver with Integrated Bluetooth® Mesh

13 – TOTAL HARMONIC DISTORTION (THD) VERSUS LOAD

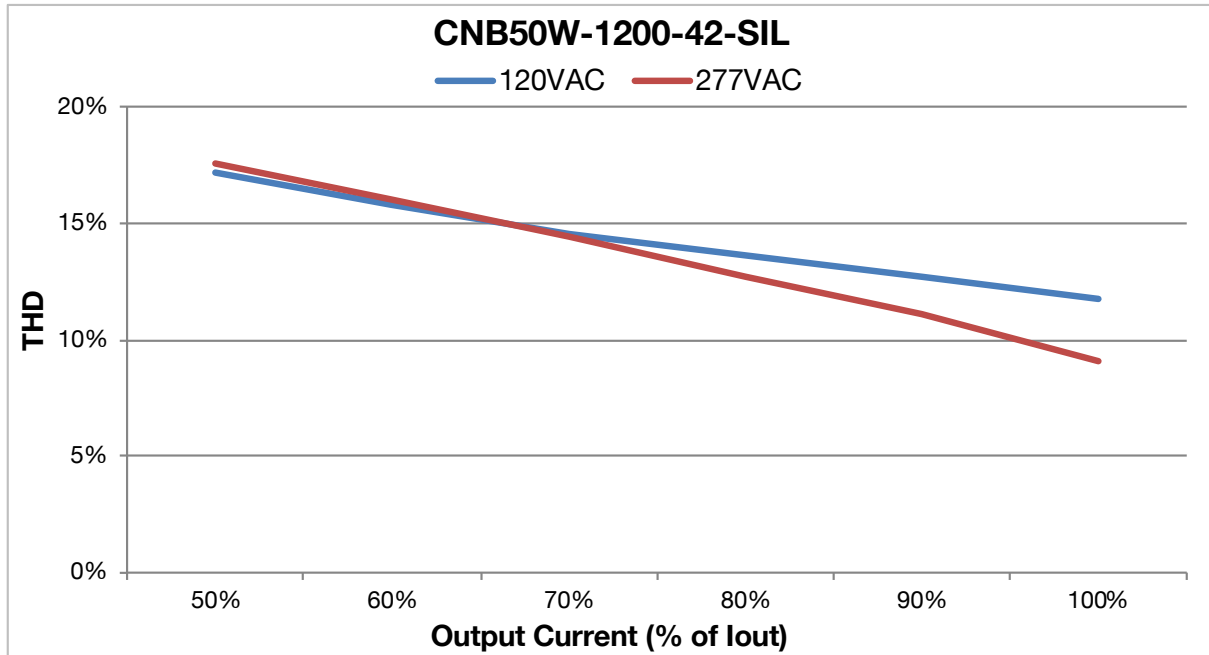

Figure 8

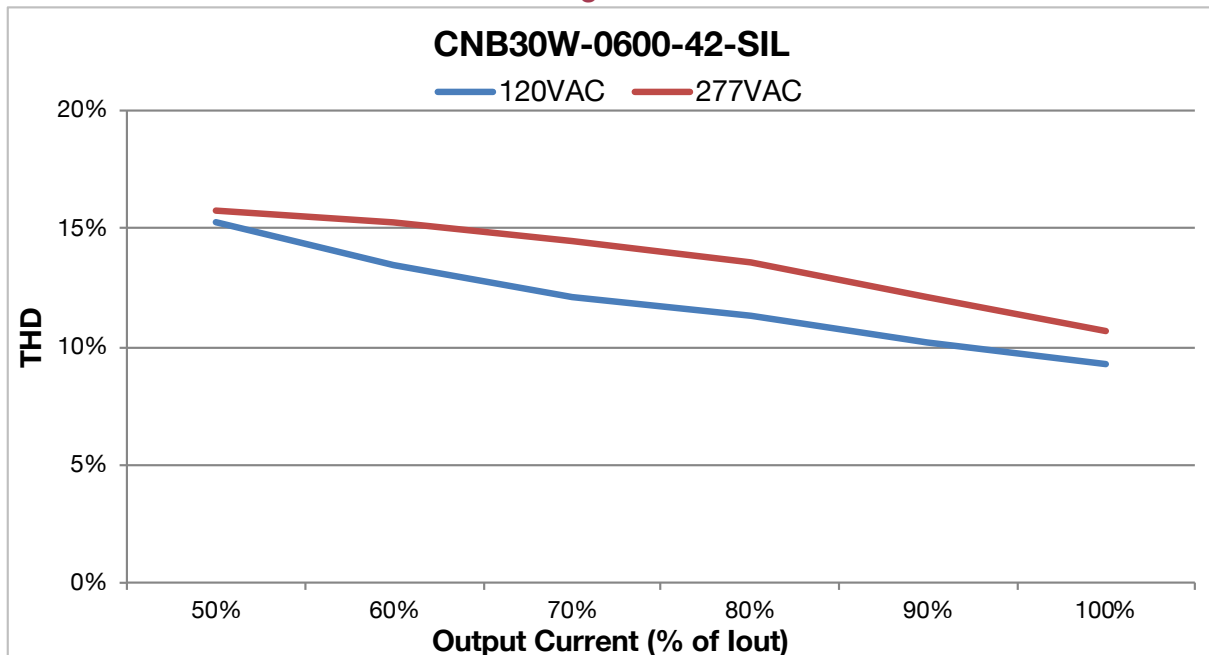

Figure 9

## 50 & 30 W Programmable CC Class 2 LED Driver with Integrated Bluetooth® Mesh

### 14 - MECHANICAL DETAILS

- **Packaging:** Aluminum case
- **I/O Connections:**
  - **Models with flying leads:** 18 AWG on all leads, 203mm (8 in) long, 105°C rated, stranded, stripped by approximately 9.5 mm, and tinned. All the wires, on both input and output, have a 300 V insulation rating.
- **Ingress Protection:** IP20 rated
- **Mounting Instructions:** The CNB50/30 driver case must be secured on a flat surface through the two mounting tabs, shown here below in the case outline drawings.

### 15 - OUTLINE DRAWINGS

**Dimensions:** L 103.5 \* W 27.3 \* H 22.65 mm (L 4.07 \* W 1.07 \* H 0.89 in.)

**Volume:** 64.0 cm<sup>3</sup> (3.89 in<sup>3</sup>)

**Weight:** 114 g (4.02 oz)

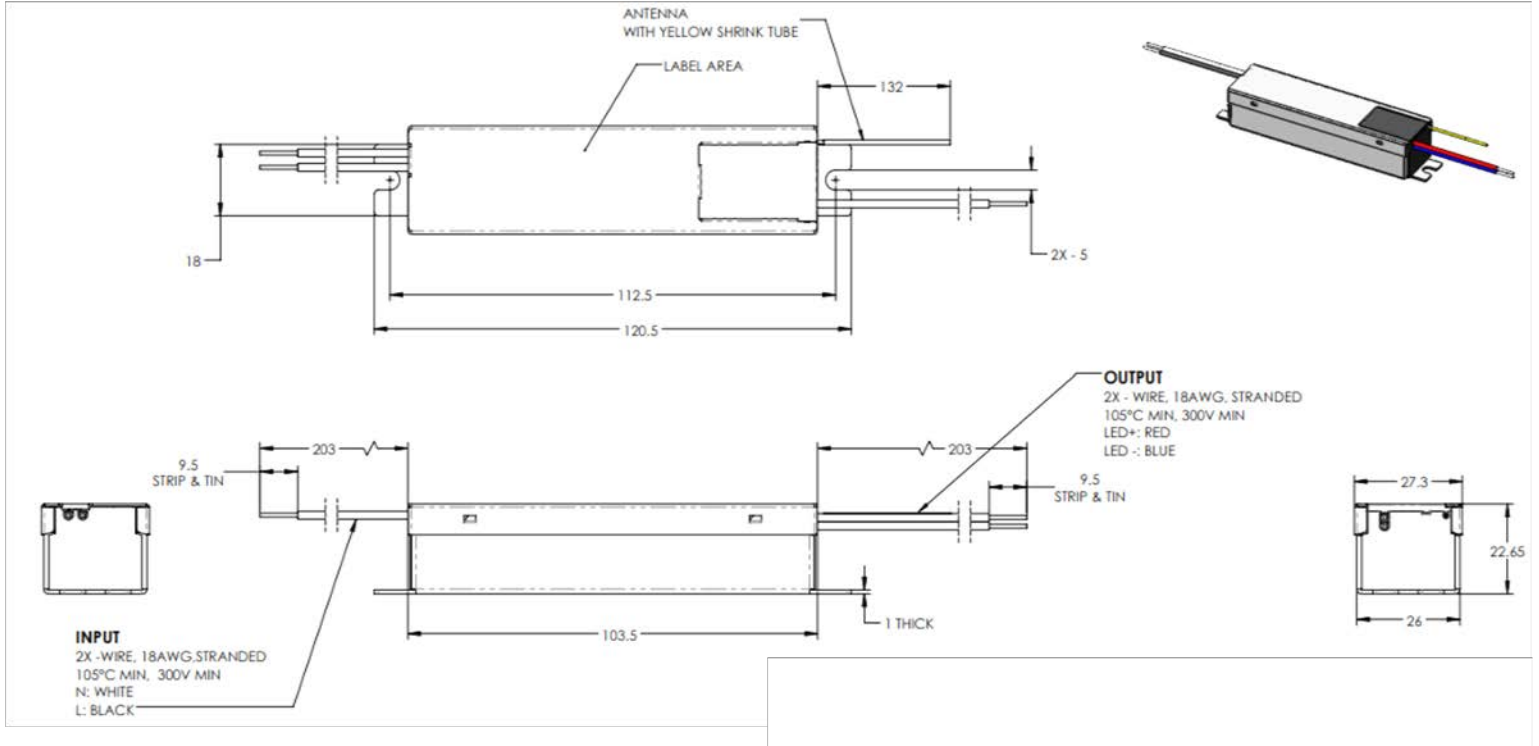

All dimensions are in mm

**Figure 10**

## 50 & 30 W Programmable CC Class 2 LED Driver with Integrated Bluetooth® Mesh

### 16 - LABELING

The CNB50W-1200-42-SILF is used in figure 11 as an example to illustrate a typical label.

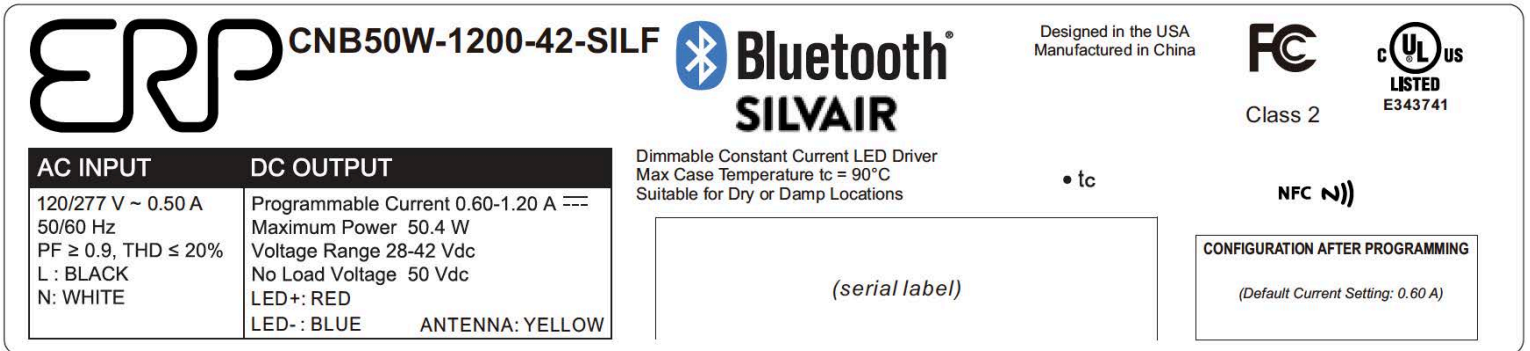

Figure 11

**USA Headquarters**  
Tel: +1-805-517-1300  
Fax: +1-805-517-1411  
893 Patriot Drive, Suite E,  
Moorpark, CA 93021, USA

**CHINA Operations**  
Tel: +86-756-6266298  
Fax: +86-756-6266299  
No. 8 Pingdong Road 2  
Zhuhai, Guangdong, China 519060

ERP Power, LLC (ERP) reserves the right to make changes without further notice to any products herein. ERP makes no warranty, representation or guarantee regarding the suitability of its products for any particular purpose, nor does ERP assume any liability arising out of the application or use of any product or circuit, and specifically disclaims any and all liability, including without limitation special, consequential or incidental damages. "Typical" parameters which may be provided in ERP data sheets and/or specifications can and do vary in different applications and actual performance may vary over time. All operating parameters, including "Typicals" must be validated for each customer application by customer's technical experts. ERP does not convey any license under its patent rights nor the rights of others. ERP products are not designed, intended, or authorized for use as components in systems intended for surgical implant into the body, or other applications intended to support or sustain life, or for any other application in which the failure of the ERP product could create a situation where personal injury or death may occur. Should Buyer purchase or use ERP products for any such unintended or unauthorized application, Buyer shall indemnify and hold ERP and its officers, employees, subsidiaries, affiliates, and distributors harmless against all claims, costs, damages, and expenses, and reasonable attorney fees arising out of, directly or indirectly, any claim of personal injury or death associated with such unintended or unauthorized use, even if such claim alleges that ERP was negligent regarding the design or manufacture of the part. ERP is an Equal Opportunity/Affirmative Action Employer. This literature is subject to all applicable copyright laws and is not for resale in any manner.

**50 & 30 W Programmable CC Class 2 LED Driver  
with Integrated Bluetooth® Mesh**

**Revision History**

<b>Date</b>	<b>Comments</b>
02MAR2020	Initial Release
11MAR2020	Specific version with –SILF for Future Lighting North America