



The new Fortimo downlight module (DLM) EaseSelect (ES) is an integrated module with a 0-10V 1% dimmable driver inside, enabling speed on design, assembly and installation. It also offers a self-cooling feature up to 1,500lm*, eliminating the need for an external heat sink.

Commercial Product Name	12NC	Box Quantity
Fortimo LED DLM ES 2000 830 0-10V G1 NA	929000792113	32
Fortimo LED DLM ES 2000 835 0-10V G1 NA	929000792213	32
Fortimo LED DLM ES 2000 840 0-10V G1 NA	929000792313	32

*Please refer to product's design-in guide for further details and conditions.

Fortimo DLM ES 0-10V G1 NA 2000lm

Features

- High system efficiency (>95lm/W – including driver)
- Self-cooling up to 1,500 lm*
- Class 2 LED driver**
 - 120V–277V, 0–10V dimming, 1% dimmable
 - Comparable flicker performance as Advance Xitanium SmartMate drivers. Contact your account manager for more details.
- L2 LED module
 - 3 SDCM, CRI 80
 - 3 CCTs (3000K, 3500K, 4000K)
 - 3 lumen packages (1,100lm, 1,500lm, 2,000lm)

Benefits

- Fewer components as compared to current offering = less BOM and manufacturing costs
- Fast assembly and installation time
- Specifications compatible with market standards (no compromise due to integration)
- Improved serviceability as compared to current offering

Application

- Offices
- Retail
- Hospitality

Electrical Input Data

Specification Item	Value	Unit	Condition
Rated Input Voltage	120~277	V	AC
Rated Input Frequency	50~60	Hz	
Rated Input Current	0.17/0.077	A	Typical current @120V AC 60Hz/277V 60Hz
Power @277V AC 60HZ	19.5	W	Typical
Power Factor	>0.9		
Total Harmonic Distortion	<15	%	Typical current @120V AC 60Hz/277V 60Hz
Dimming	0-10V dimmable		100-1%
Surge Protection (Combi-Wave, KV)	2.5	Kv	100kHz Ring Wave (w/t 30Ω)
Envir. Protection Rating	UL damp & dry		
Approval Marks	UL, UL SREC, CSA, RoHS		

Typical specifications stated at Tc-nom.
Power range -4% to + 4%.

* Please refer to product's design-in guide for further details and conditions.

** This integrated module is a non-class 2 system with an integrated class 2 driver.

Fortimo DLM ES 0-10V G1 NA 2000lm

Optical Characteristics – Table per CCT

Fortimo LED DLM ES 2000 830 0-10V G1 NA

Parameter	Min.	Typ.	Max.	Unit
Flux (at Tc-nom)		1970		lm
Efficacy (at Tc-nom)		99		lm/W
Reference Correlated Color Temperature (CCT)		3000		K
CRI	80			-
Radiation Angle		108		deg

Specifications stated at Tc-nom (70°C).

Color consistency of 3 SDCM, averaged over the module.

Measurement tolerance is: ± 5% for the flux data, ± 5% for the efficacy data, and ± 1.5 for the CRI data.

Flux range -10% to +20%. Power range -4% to + 4%. Efficiency range respective to flux and power ranges.

Spectrum of DLM ES

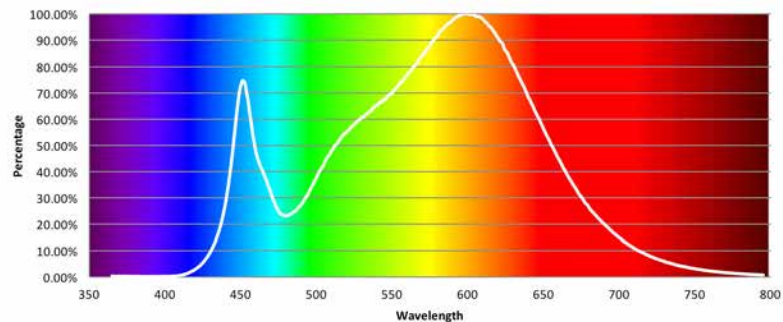

Optical Characteristics – Table per CCT

Fortimo LED DLM ES 2000 835 0-10V G1 NA

Parameter	Min.	Typ.	Max.	Unit
Flux (at Tc-nom)		2000		lm
Efficacy (at Tc-nom)		100		lm/W
Reference Correlated Color Temperature (CCT)		3500		K
CRI	80			-
Radiation Angle		108		deg

Specifications stated at Tc-nom (70°C).

Color consistency of 3 SDCM, averaged over the module.

Measurement tolerance is: ± 5% for the flux data, ± 5% for the efficacy data, and ± 1.5 for the CRI data.

Flux range -10% to +20%. Power range -4% to + 4%. Efficiency range respective to flux and power ranges.

Spectrum of DLM ES

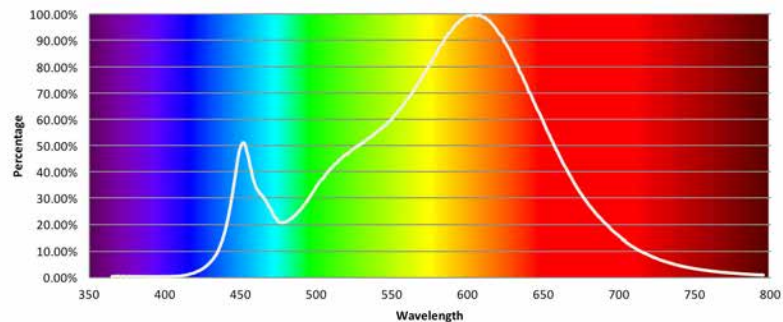

Fortimo DLM ES 0-10V G1 NA 2000lm

Optical Characteristics – Table per CCT

Fortimo LED DLM ES 2000 840 0-10V G1 NA				
Parameter	Min.	Typ.	Max.	Unit
Flux (at Tc-nom)		2060		lm
Efficacy (at Tc-nom)		103		lm/W
Reference Correlated Color Temperature (CCT)		4000		K
CRI	80			-
Radiation Angle		108		deg

Specifications stated at Tc-nom (70°C).

Color consistency of 3 SDCM, averaged over the module.

Measurement tolerance is: ± 5% for the flux data, ± 5% for the efficacy data, and ± 1.5 for the CRI data.

Flux range -10% to +20%. Power range -4% to + 4%. Efficiency range respective to flux and power ranges.

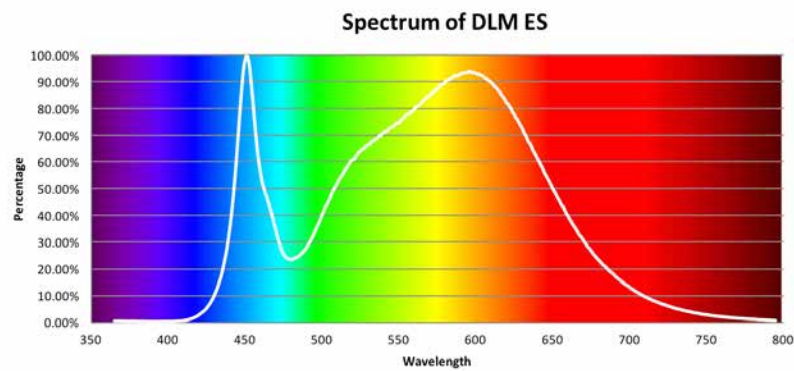

Beam Shape

The Fortimo DLM ES generates a Lambertian beam shape, which is a pragmatic starting point for OEMs wishing to design secondary optics.

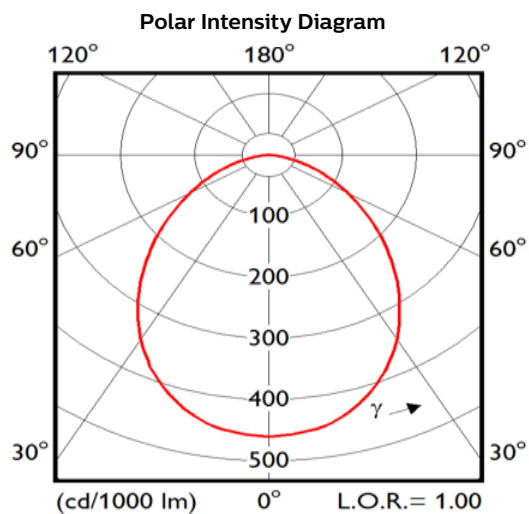

Fortimo DLM ES 0-10V G1 NA 2000Im

Module Temperatures

Parameter	Nominal*	Life**	Max.***	Unit
Tc (case temperature at Tc point)	70	75	85	°C

* Nominal value at which typical performance is specified.

** Value at which lifetime is specified.

** Note: Modules Tc Life of 75°C has a comparable thermal power of a L2 board at Tc=85°C.

*** Maximum value for safe operation (UL); do not operate above this value.

Inrush Current Info

Vin	Ipeak	T (@ 10% of Ipeak)
120 Vrms	1.9	48
277 Vrms	5.3	120

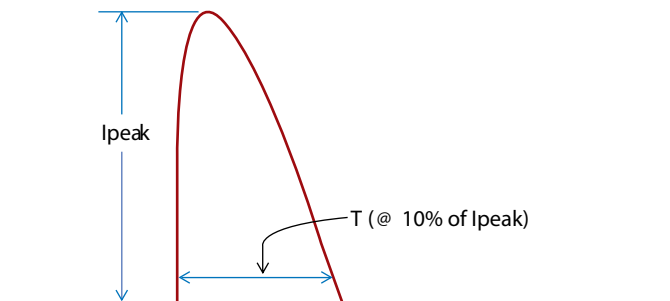

Abs Max. Ratings

Parameter	Min.	Typ.	Max.	Unit
Ambient Temperature	-20		65	°C
Ambient Relative Humidity (non-condensing)	10		90	%
Operating Pressure			290	hPa
Input Voltage	120		277	Vac
Storage Temperature	-25		85	°C
Storage Relative Humidity (non-condensing)	5		95	%

Thermal Switching Cycles

Tc	Cycles
75	28K
70	42K
65	>50K
60	>50K
55	>50K

Maximum number of cycles allowed over lifetime (varying according to different Tc values @Ta=25C).

Fortimo DLM ES 0-10V G1 NA 2000lm

Mechanical Characteristics

Parameter	Min.	Typ.	Max.	Unit
Height	43.4	43.6	43.8	mm
Width	82.6	82.8	83	mm
Length Excl. Conduit Fitting Base	81.4	81.6	81.8	mm
Length Incl. Conduit Fitting Base	104.4	104.6	104.8	mm

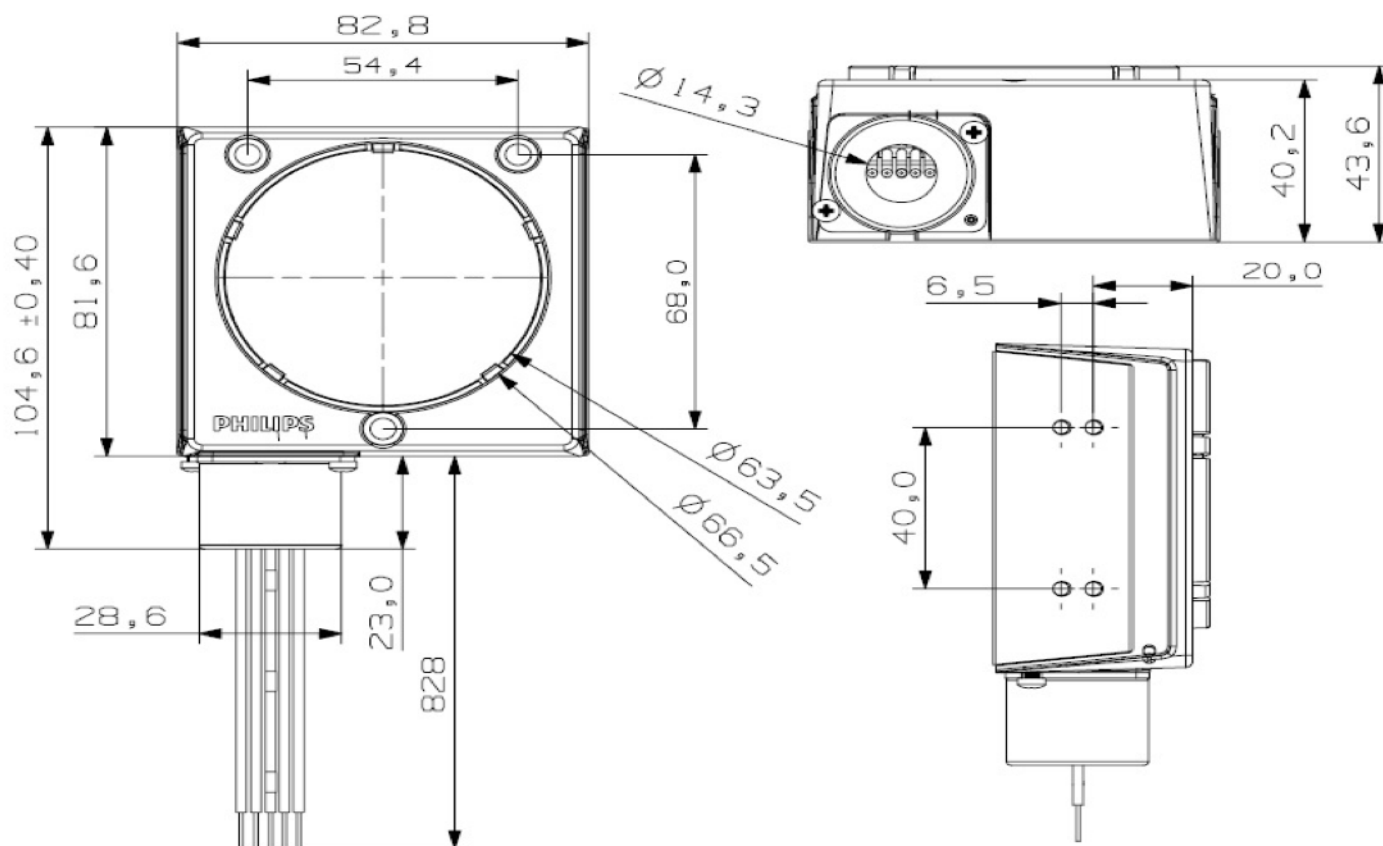

Unmarked tolerances +/-0.2mm

Application Information

Compliance and Approval

UL (E336402), UL SREC (UL991), CSA

Application Information

IP Rating	No IP Rating
Overheating Protection	UL SREC
Luminaire Class	Non-Class 2

Fortimo DLM ES 0-10V G1 NA 2000lm

Flux and Efficacy Versus Temperature at Tc

	Tc [°C]	Flux [%]	Efficacy [%]
(Tc-Max.)	85	97%	97%
Tc-Life	75	99%	99%
Tc-Nom	70	100%	100%
	60	102%	102%
	50	104%	103%
	40	105%	105%
	30	107%	106%
	20	108%	107%
	10	110%	108%
(0 degC)	0	111%	109%

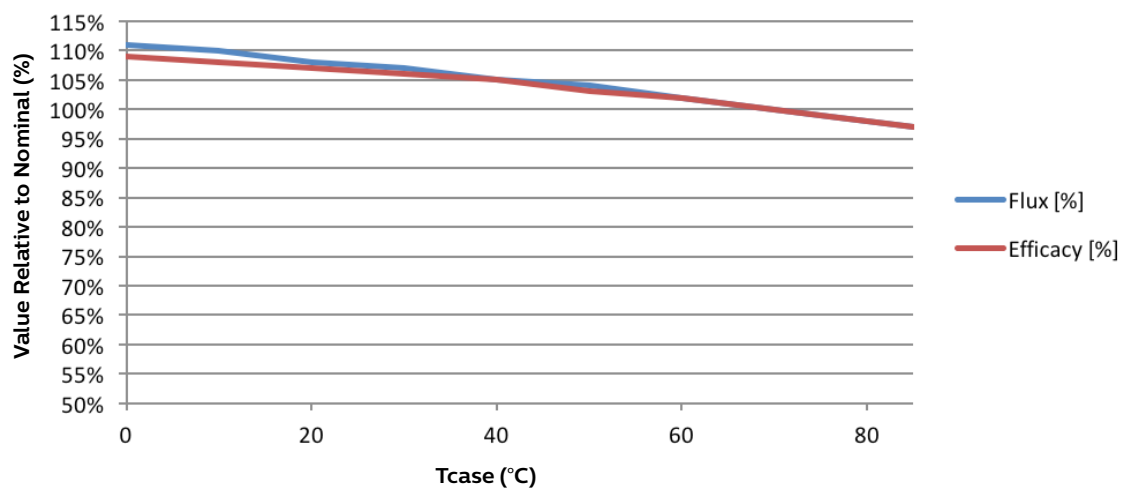

Fortimo DLM ES 0-10V G1 NA 2000lm



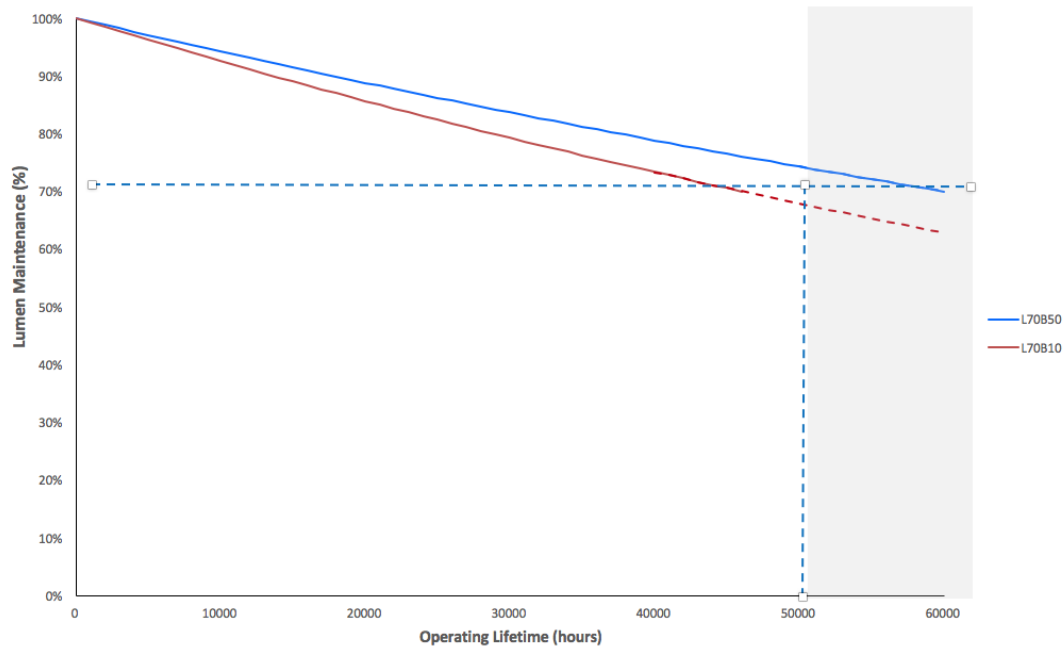

Lumen Maintenance at Tc-life Conditions



Parameter

Parameter	Min.	Typ.	Max.	Unit
$\Delta u'v'$ at 6000 hours			0.007	-

Wiring Schematic

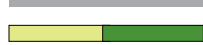
	Neutral (White)
	Line (Black)
	Dim + (Purple)
	Dim - (Gray)
	Function GND only (Yellow-Green)

Warning: Install in accordance with national and local electrical codes.

Wires are 18AWG solid copper wires.

Rated $\geq 300V/105^{\circ}C$

Grounding:

Metal case must be grounded.

Note:

Removable conduit interface is suitable for 5/16" conduit cable.

The information presented in this document is not intended as any commercial offer and does not form part of any quotation or contract.

