

UV module Solution
specification

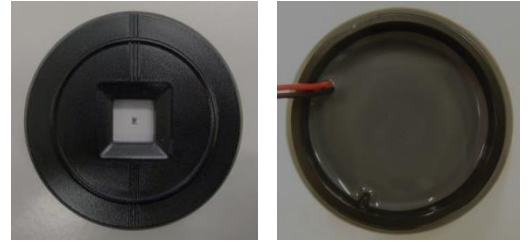

Product Brief

Description

- CMW-FCC-CO1A is disinfection Module with UV LED mounted on the Metal PCB
- UV module is suitably designed for water and surface sterilization.

Features and Benefits

- Waterproof
- Deep ultraviolet LED
- Simple BOM
- Miniaturization
- Lead Free Product

Key Applications

- Disinfection

Table 1. Product

Model	Color	IP Grade	IF [mA]	Φ_e [mW]	Wp [nm]		Remark
					Min	Max	
CMW-FCC-CO1A	Black	IPX8	100	7.0	270	280	Constant current drive

* Above data base on DC Power Supply(Not SMPS)

Table of Contents

Index	
• Product Brief	
• Table of Contents	
• Performance Characteristics	
• Characteristic Diagrams	
• Part List	
• Mechanical Dimension	
• Packing	
• Precaution for Use	

Performance Characteristics

Table 2. Electro Optical Characteristics at 100mA

 (T_a=25°C RH=30%)

Parameter	Symbol	Value			Unit
		Min.	Typ.	Max.	
Peak wavelength ^[1]	λ_p	270	275	280	nm
Forward Voltage ^[2]	V _F	5	6.5	8.0	Vdc
Power Consumption	P	0.5	0.65	0.8	W
Radiant Flux ^[3]	Φ_e ^[4]	7.0			mW
Spectrum Half Width	$\Delta\lambda$	10			nm
Weight	g	16.0±1.0			g

Notes :

- (1) Peak Wavelength Measurement tolerance : ±3nm
- (2) Forward Voltage Measurement tolerance : ±3%
- (3) Radiant Flux Measurement tolerance : ±10%
- (4) Φ_e is the Total Radiant Flux as measured with an integrated sphere.
- (5) All measurements were made under the standardized environment of Seoul viosys

Table 3. Absolute Maximum Ratings

Parameter	Symbol	Unit	Value
Maximum Input Current	I _f	mA	100
Operating Temperature	T _{opr}	°C	-20 ~ +60
Storage Temperature	T _{stg}	°C	-40 ~ +85

Table 4. Reliability

Item	Test Condition	Test Time ,Cycle	Evaluation Items	Q'ty	Result
Room Temp. Operating	<ul style="list-style-type: none"> ▶ Ta = 25°C ▶ IF = Constant Current (100mA) 	1,000 [hr]	<ul style="list-style-type: none"> ▶ Po = within 50.0% ▶ VF = within 10.0% ▶ Wp = within 1.0% 	5	Pass
High Temp. High Humi. Operating	<ul style="list-style-type: none"> ▶ Ta = 60°C ▶ RH = 90% ▶ IF = Constant Current (100mA) 		<ul style="list-style-type: none"> ※ Compared to the initial value 	5	Pass
Thermal Shock	<ul style="list-style-type: none"> ▶ Ta max = +85°C ▶ Ta min = -40°C ※ 30min dwell / Transfer time=10s ※ 1Cycle = 1hr 	200 [Cycle]	▶ No Open	5	Pass
ESD	<ul style="list-style-type: none"> ▶ R=1.5kΩ, C=100pF, ▶ Voltage level=2 kV 	3 Times	▶ No Open	5	Pass

Characteristic Diagrams

Fig1. Relative Voltage vs. Current [Ta=25°C]

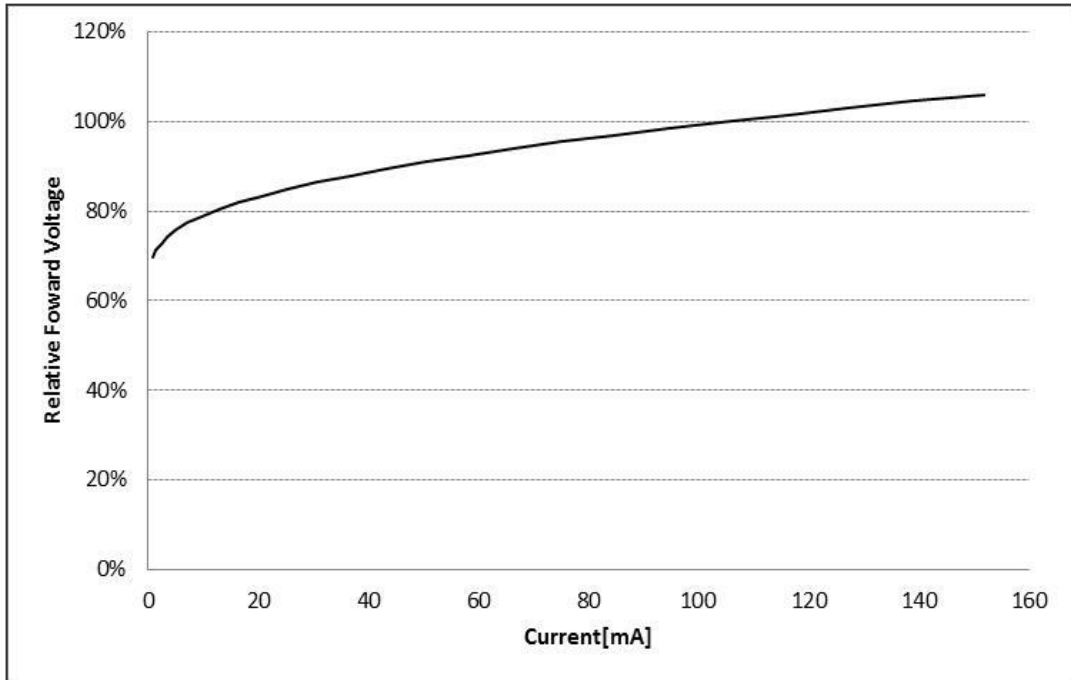
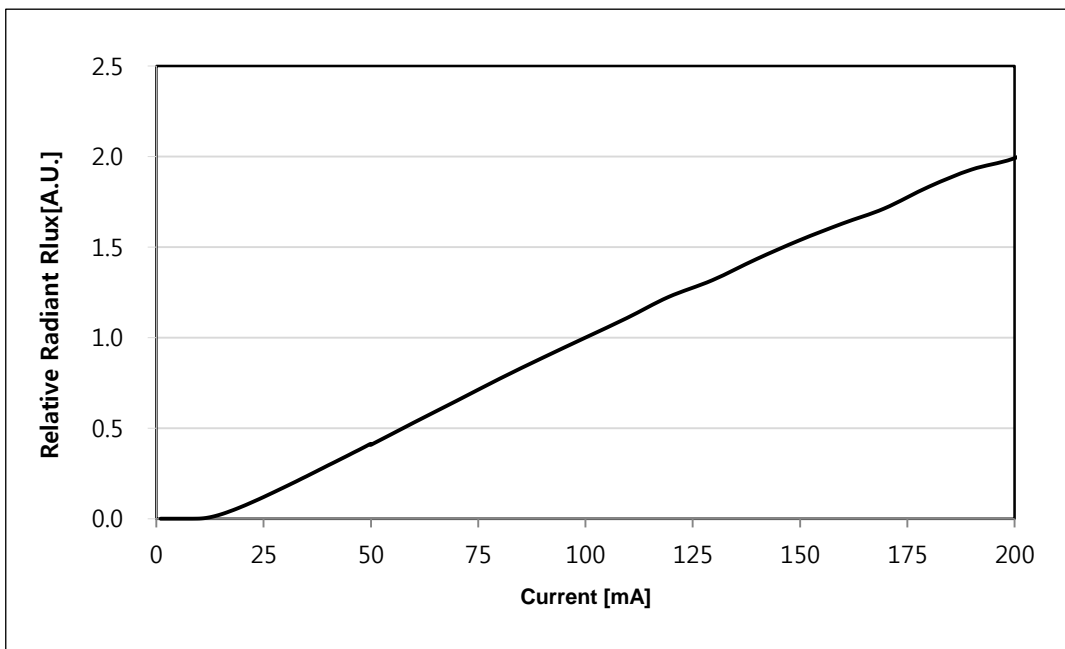

Fig2. Relative Radiant Flux vs. Current [Ta=25°C]



Characteristic Diagrams

Fig3. Wavelength

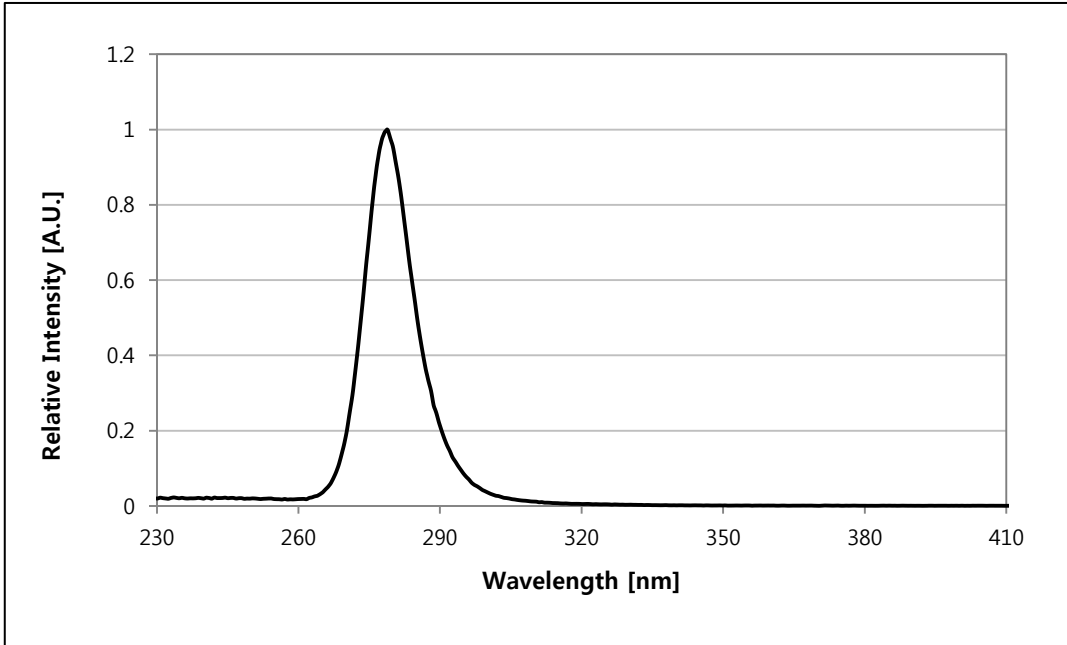
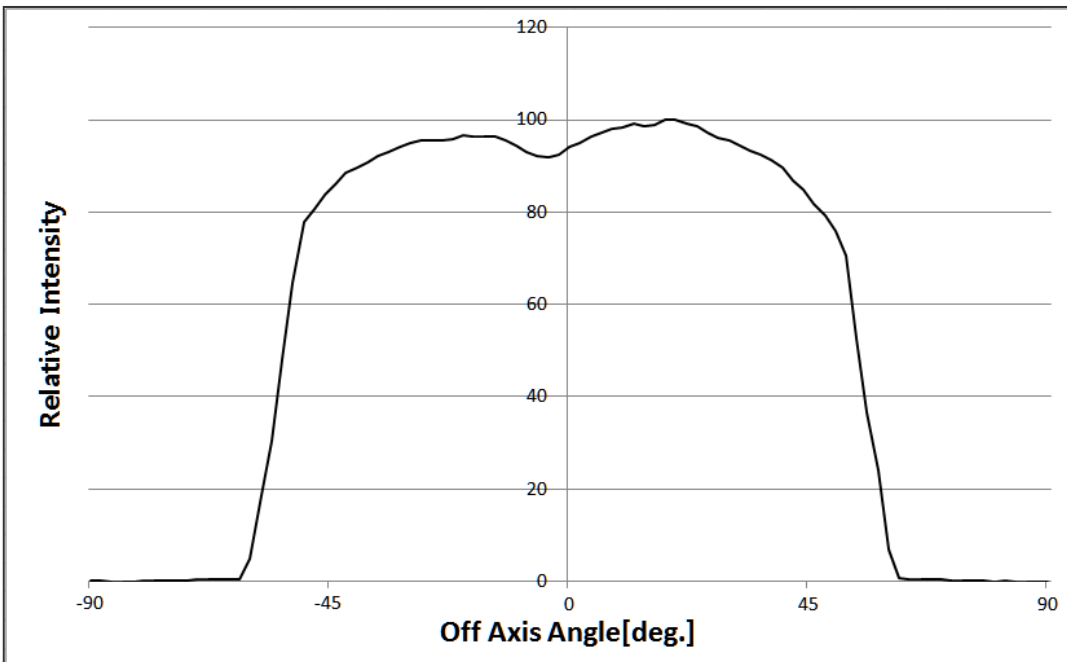
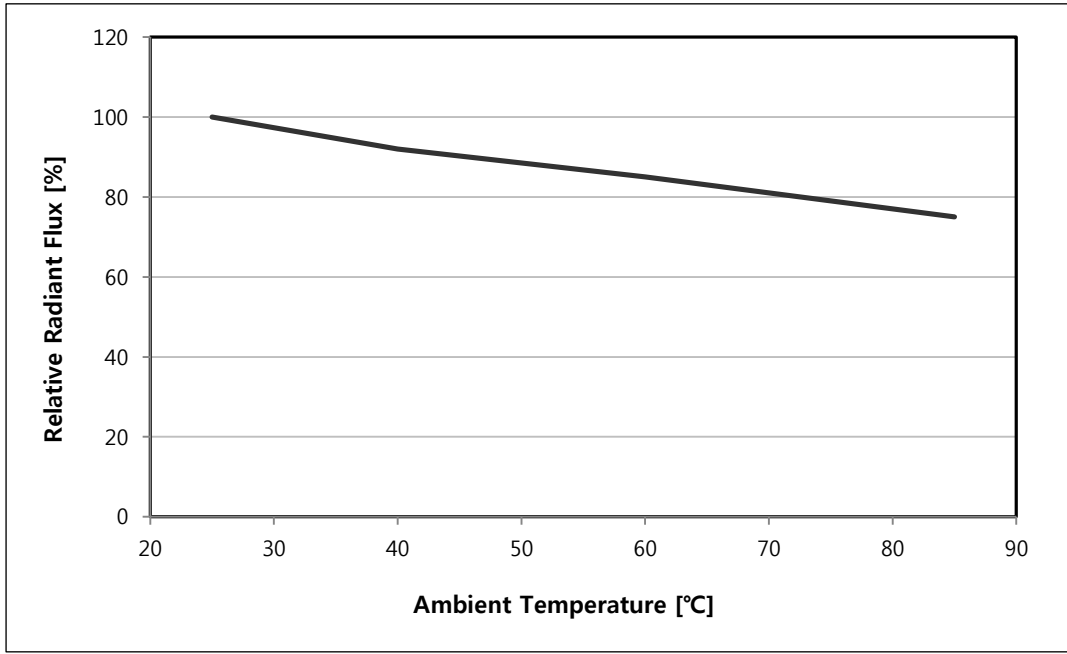

Fig4. Radiation pattern



Characteristic Diagrams

Fig5. Relative Radiant Flux vs. Ambient Temperature



Part list

Table 3. Part List
Unit : mm

No	Model	Item Specification	Quantity
1	CMW-FCC-CO1A	Module Guard (Material : POM, Black)	1
		Outer Guard (Material : POM, Black)	1
		Quartz Glass	1
		Quartz Rubber (Material : Silicone, Black)	1
		Outer Rubber (Material : Silicone, Gray)	1
		Screw (M2.6 X L5)	3
		LED PCB ASS'Y	1
		Wire (UL1571, AWG28)	2
		Silicone Molding (Material : SE-9189L, Gray)	

Mechanical Dimensions

Unit : mm

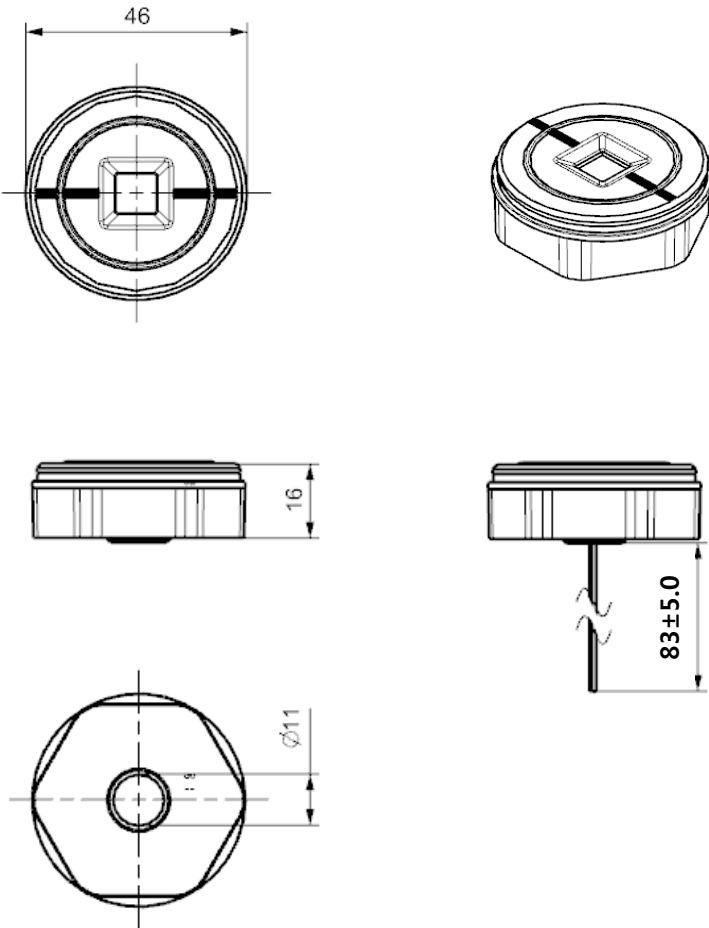

“UV Module” Assembly Guide

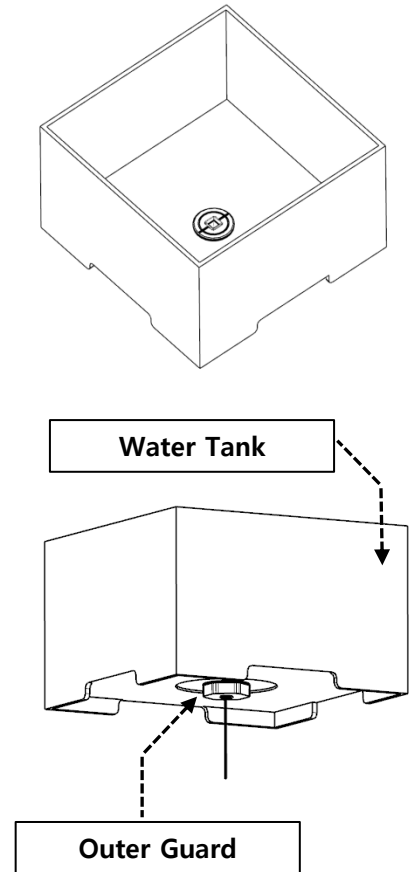

Notes :

- “Outer Guard” When assembly, the torque varies depending on the material and thickness of the product. Test and use it to suit your environment.

[SVC does not guarantee about assembly failure for Outer Guard.]

- Dimensions of the indicated maximum value, and to allow a tolerance : ± 0.5 [mm]

Packing

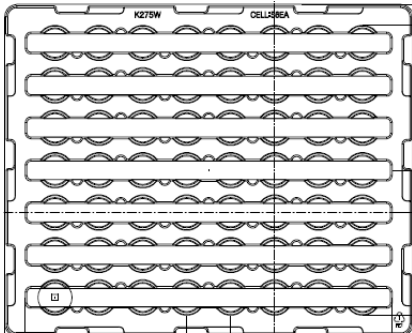

* 56ea UV LED modules packed per tray

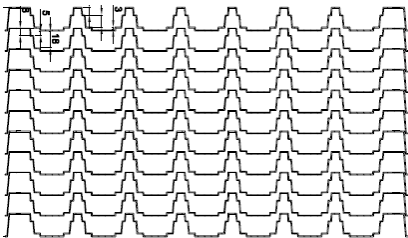

* UV LED Module 10ea Trays and additional 1 dummy tray each up of box

Pack the tray in a box

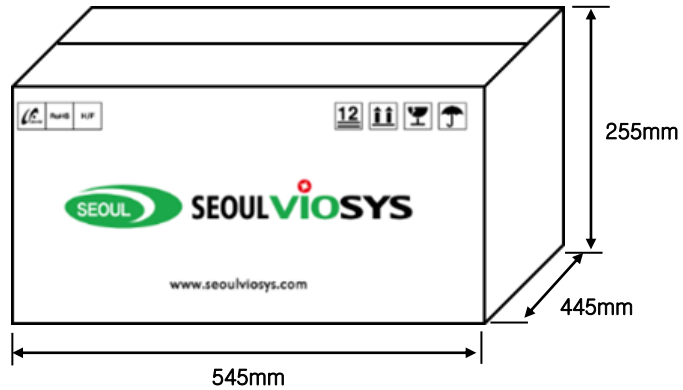

* 1BOX : 56ea per tray x 10Trays = 560ea

* TOTAL : 560ea per 1BOX

* If it is not a full box, apply the buffer material to fix the product

Precaution for Use

1) Storage

- To avoid moisture penetration, we recommend storing UV Module in a dry box with a desiccant. The recommended temperature and Relative humidity are between 5°C and 30°C and below 50% respectively.
- Replace the remained UV Module into the moisture-proof bag and reseal the bag after work to avoid those UV Module being exposed to moisture. Prolonged exposure to moisture can adversely affect the proper functioning of the UV Module.

2) Handling Precautions

- Do not use inflammable material nearby the products.
- Do not touch the products with wet hand
- Do not fix or remodel the products.
- Do not drop the machine, or give strong impact on the products.
- UV Module needs to be handled carefully as below
 - Avoid touching quartz glass parts especially with sharp tools such as Tweezers
 - Avoid leaving fingerprints cover parts.
 - UV Module will attract dust so use covered containers for storage.

Precaution for Use

3) Safety for eyes and skin

- The Products emit high intensity ultraviolet light which can make your eyes and skin harmful, So do not look directly into the UV light and wear protective equipment during operation.

4) Cleaning

- After assembly the product, empty the water and then wipe the UV Module with a dry towel.

5) Others

- Be sure to turn On / Off after module is connected.

When connecting the module in the power on state, LED can be damaged by the influence of the inrush voltage / current.

- Do not handle this product with acid or sulfur material in sealed space
- Please handle using equipment that prevents static electricity.
- Do not touch unless ESD protection is used.
- grounding and keeping appropriate humidity are necessary for work environment.

