



LED HIGH POWER

C03 UV Product Series

Data Sheet

Created Date: 09 / 03 / 2014
Revision: 3.4, 07 / 23 / 2015

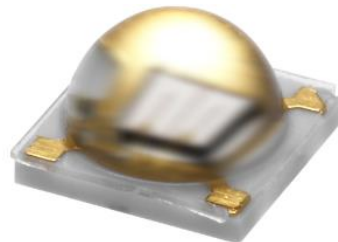

LED HIGH POWER C03 UV Product Series

1. Description

The LiteON C03 UV Product series is a revolutionary, energy efficient light source for UV curing and common UV application, combining the lifetime and reliability advantages of Light Emitting Diodes with the brightness of conventional light source. It gives you design freedom, and creating a new opportunities for solid state UV light source to displace conventional UV technologies.

1.1 Features

- I.C. compatible
- RoHS compliant and Pb free
- Lower operating costs
- Reduced maintenance costs

1.2 Available Part Numbers

Nominal peak wavelength (nm)	Forward Voltage	Part Number
W365	4.0V	LTPL-C034UVH365
W385	3.7V	LTPL-C034UVH385
W405	3.7V	LTPL-C034UVH405

LED HIGH POWER C03 UV Product Series

2. Outline Dimensions

2.1 Form Factor

■ LTPL-C034UVHXXX

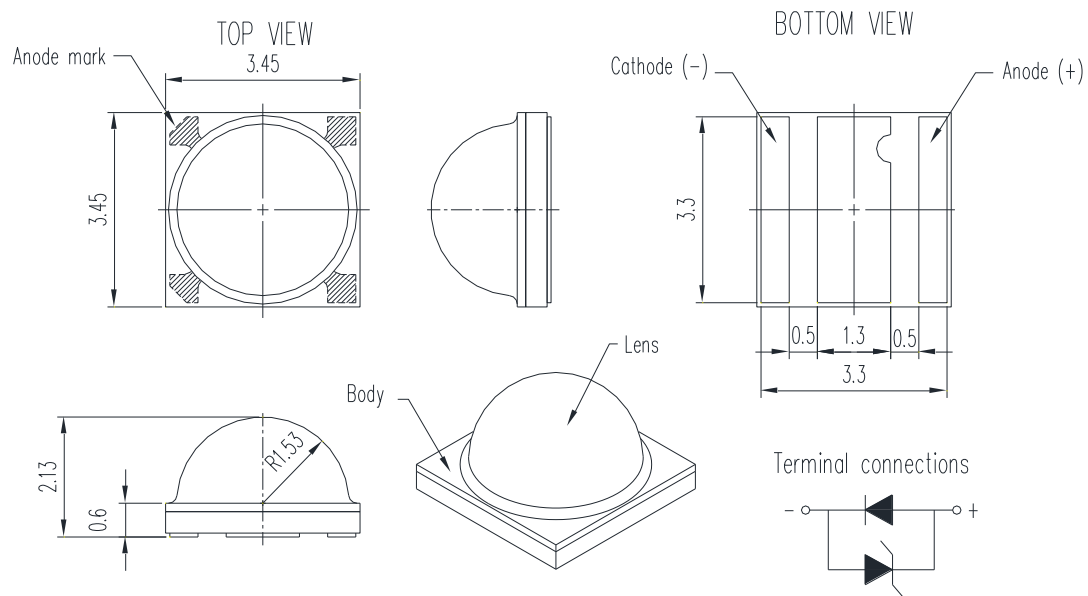

Notes

1. All dimensions are in millimeters and dimension tolerances are $\pm 0.2\text{mm}$ except lens height and ceramic length / width dimension tolerance are $\pm 0.1\text{mm}$.
2. Thermal pad of the device is electrically neutral from the anode and cathode pads.

LED HIGH POWER C03 UV Product Series

3. Rating and Characteristics

3.1 Absolute Maximum Ratings at Ta=25°C.

Parameter	Symbol	Rating	Unit
Power Dissipation	Po	3.08	W
DC Forward Current	IF	700	mA
Junction Temperature	Tj	90	°C
Operating Temperature Range	Topr	-40~+85	°C
Storage Temperature Range	Tstg	-55~+100	°C

Notes

1. The pulse mode condition is 1 KHz with 0.1msec pulse width.
2. Forbid to operating at reverse voltage condition.

LED HIGH POWER C03 UV Product Series

3.2 Electro-Optical-Thermal Characteristics

■ LTPL-C034UVHXXX

Peak Wavelength	Current (mA)	View Angle $2\theta_{1/2}$	Typ. VF (V) @25°C	Typ. mW @25°C	Typ. VF (V) @85°C	Typ. mW @85°C	WPE(%) @25°C	WPE(%) @85°C	Rth °C/W
365	500	130	4.0	665	3.8	492	33.3%	25.9%	5.1
385	500	130	3.7	975	3.6	795	50.6%	44.1%	4.1
405	500	130	3.7	1000	3.5	896	54.0%	51.2%	3.0

Notes

1. All of the VF value are typical and the real bin range please refer page 13 "VF Binning Parameter".
2. All of the Flux value are typical and the real Bin range please refer page 13 "Flux Binning Parameter".
3. Typical viewing angle is 130deg.
4. Thermal resistance measurement tolerance is $\pm 10\%$

4. Typical Electrical/Optical Characteristics Curve

■ Efficiency Comparison Table

4.1 Relative Radiant Flux vs. Current of LTPL-C034UVHXXX at 25°C

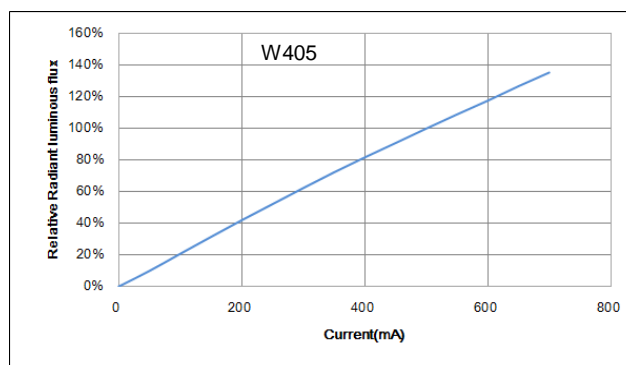
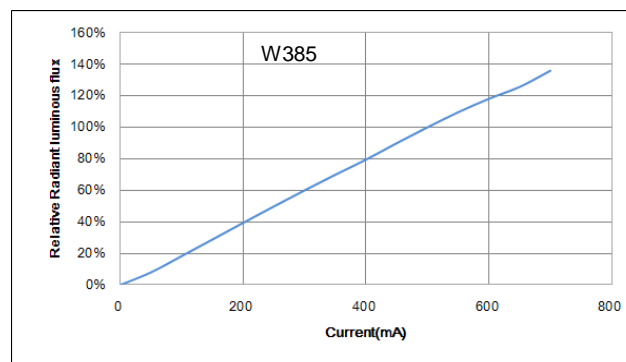
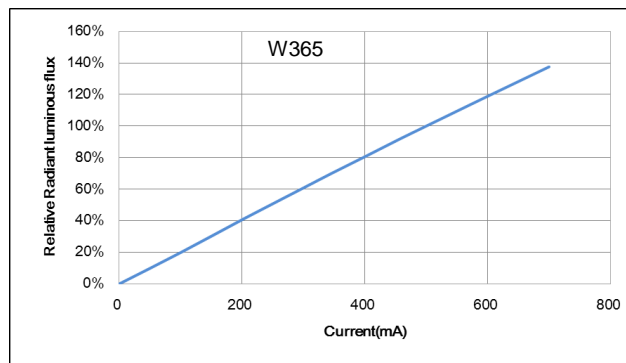

Fig 1. Typical relative Radiant flux vs. forward current of LTPL-C034UVH365, LTPL-C034UVH385 and LTPL-C034UVH405

LED HIGH POWER C03 UV Product Series

Current (mA)	W365		W385		W405	
	Vf (V)	mW	Vf (V)	mW	Vf (V)	mW
100	3.5	126.3	3.2	183.3	3.2	198.2
200	3.6	265.7	3.4	383.0	3.4	406.1
300	3.7	403.6	3.5	579.8	3.5	608.1
350	3.8	468.7	3.6	679.4	3.5	708.6
400	3.9	538.2	3.6	775.9	3.6	806.1
450	4.0	603.8	3.7	871.1	3.7	904.3
500	4.0	665.0	3.7	975.0	3.7	1000.0
600	4.1	789.5	3.8	1156.6	3.8	1189.2
700	4.1	909.0	3.9	1336.6	3.9	1375.5

LED HIGH POWER
C03 UV Product Series

4.2 Relative Spectral Distribution vs. Wavelength Characteristics at 25°C & 85°C

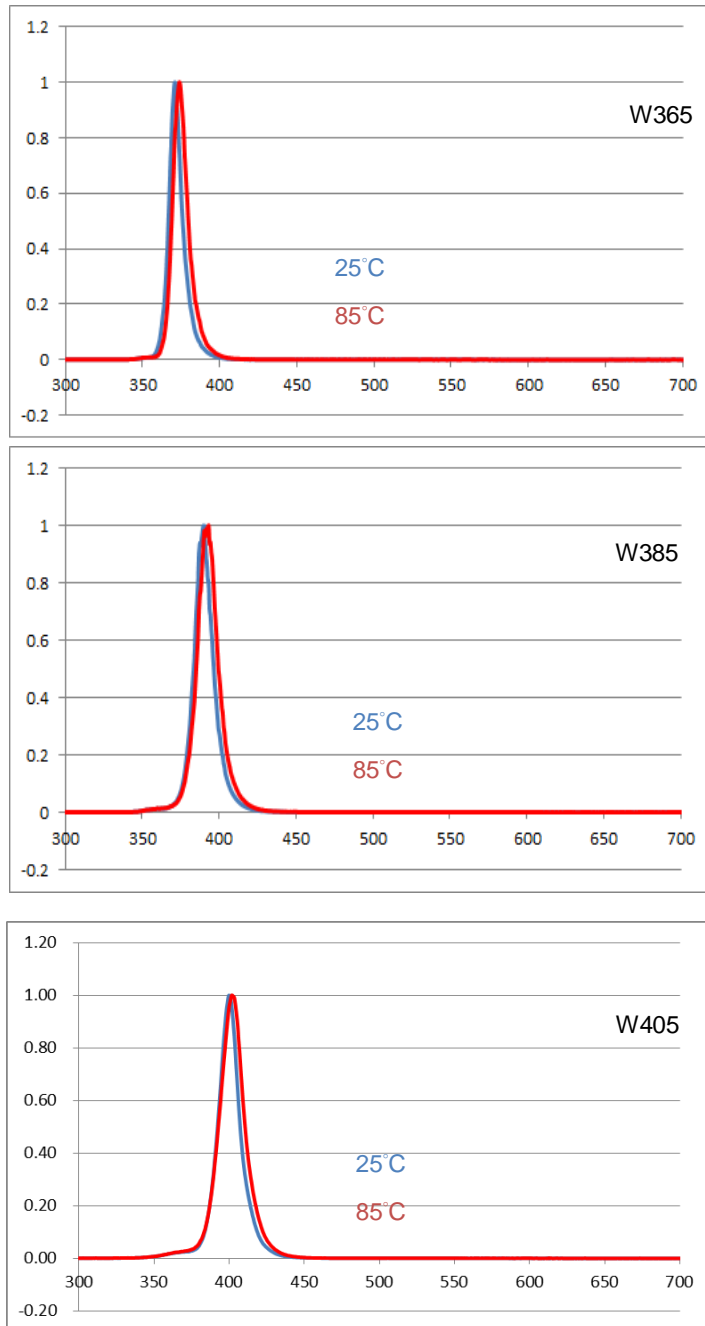

Fig 2. Relative Spectral Distribution at T_j = 25°C & 85°C

4.3 Typical Spatial Radiation Pattern

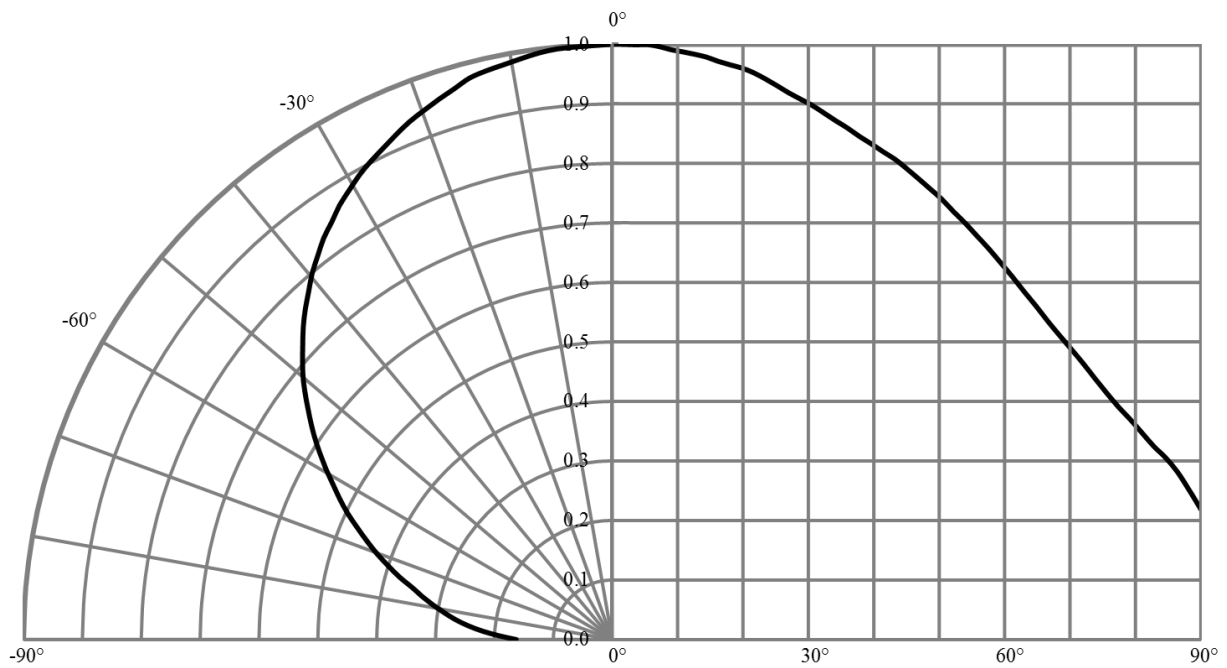

Fig 3. Radiation Characteristics

LED HIGH POWER
C03 UV Product Series

4.4 Forward Current vs. Forward Voltage at 25°C

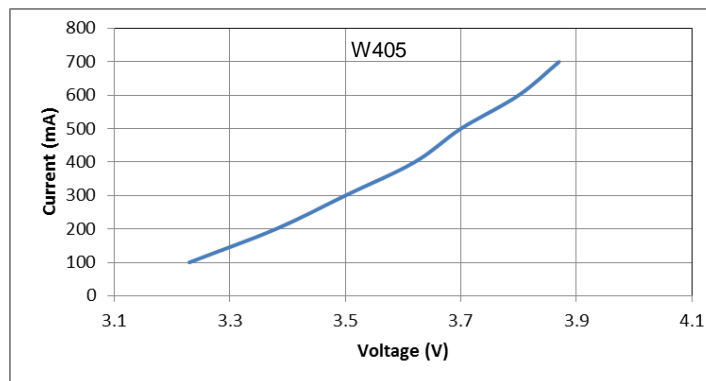
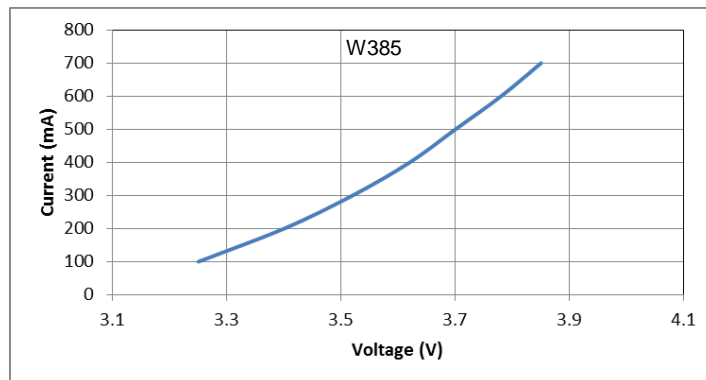
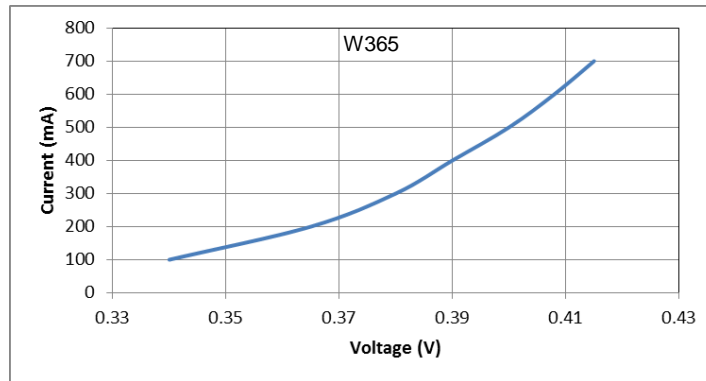

Fig 4. Forward Current vs. Forward Voltage of LTPL-C034UVHXXX

LED HIGH POWER C03 UV Product Series

4.5 Maximum Forward Current vs. Ambient Temperature

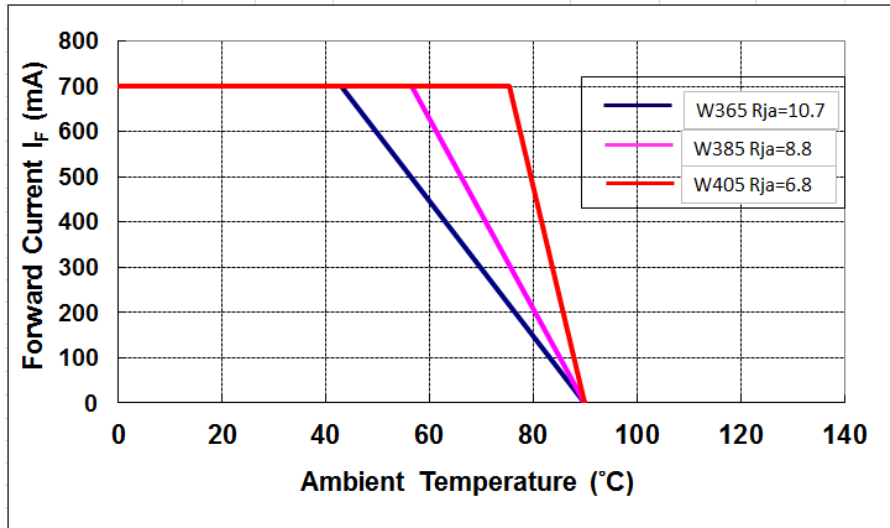

Fig 5. Forward Current Degrading Curve of LTPL-C034UVHXXX

4.6 Relative radiant flux vs. Junction Temperature

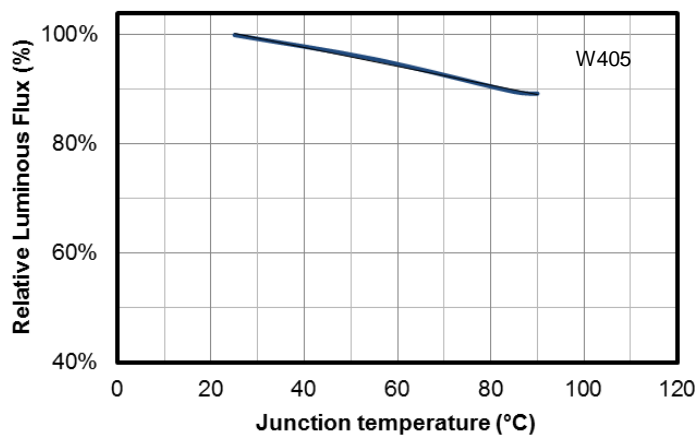
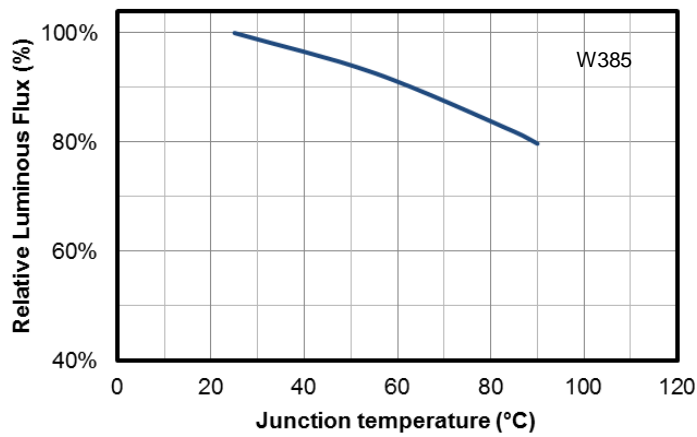
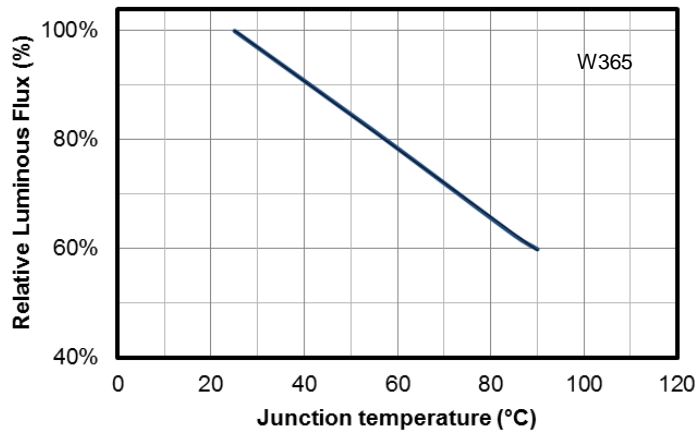

Fig.6 Ambient Temperature vs Relative Radiant Flux Curve of LTPL-C034UVHXXX

LED HIGH POWER C03 UV Product Series

5. VF Bin Definition

Forward Voltage Binning Parameter at 25°C

■ LTPL-C034UVHXXX

Parameter	Bin	Symbol	Min	Max	Unit	Condition
Forward Voltage	V1	VF	3.2	3.6	V	IF = 500mA
Forward Voltage	V2	VF	3.6	4.0	V	IF = 500mA
Forward Voltage	V3	VF	4.0	4.4	V	IF = 500mA

6. Radiant Flux Bin Definition

Radiant Flux Binning Parameter at 25°C

■ LTPL-C034UVHXXX

W365

Parameter	Bin	Symbol	Min	Max	Unit	condition
Radiant Flux	GH	ΦV	560	610	mW	If=500mA
	HI		610	665		
	IJ		665	720		
	JK		720	775		

W385

Parameter	Bin	Symbol	Min	Max	Unit	condition
Radiant Flux	MN	ΦV	835	900	mW	If=500mA
	NO		900	975		
	OP		975	1050		
	PR		1050	1135		

W405

Parameter	Bin	Symbol	Min	Max	Unit	condition
Radiant Flux	MN	ΦV	835	900	mW	If=500mA
	NO		900	975		
	OP		975	1050		
	PR		1050	1135		

LED HIGH POWER C03 UV Product Series

7. Reflow Soldering Characteristics

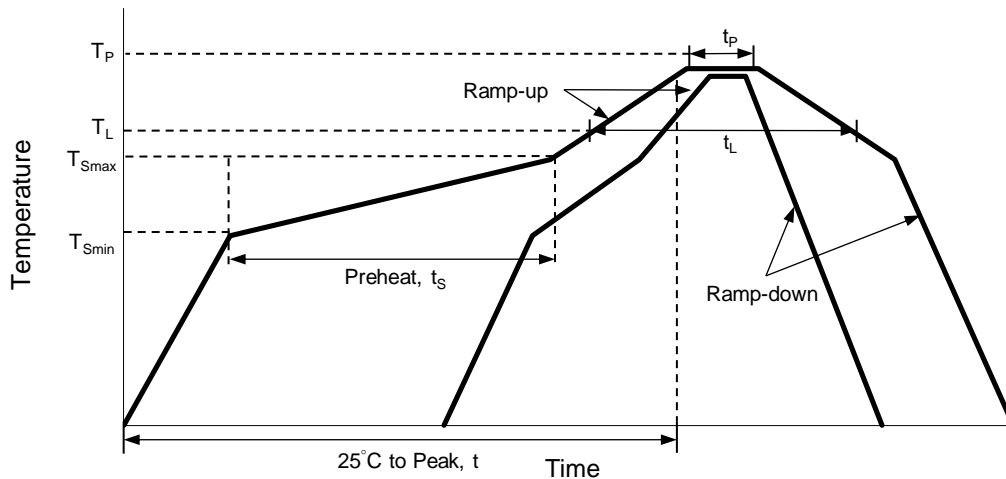

Profile Feature	Lead Free Assembly
Average Ramp-Up Rate (T_{Smax} to T_P)	3°C / second max
Preheat Temperature Min (T_{Smin})	150°C
Preheat Temperature Max (T_{Smax})	200°C
Preheat Time (t_{Smin} to t_{Smax})	60 – 180 seconds
Time Maintained Above Temperature (T_L)	217°C
Time Maintained Above Time (t_L)	60 – 150 seconds
Peak / Classification Temperature (T_P)	255°C
Time Within 5°C of Actual Peak Temperature (t_p)	5 seconds
Ramp – Down Rate	6°C / second max
Time 25°C to Peak Temperature	8 minutes max

LED HIGH POWER C03 UV Product Series

- Recommended Soldering Pad Layout

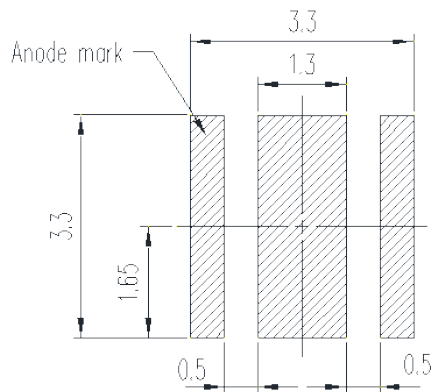

Notes:

1. The LEDs can be soldered using the reflow soldering or hand soldering method. The recommended hand soldering condition is 300°C max. and 2secs max. only once, and the operation of reflow soldering is only up to three times at maximum.
2. All temperatures refer to topside of the package, measured on the package body surface.
3. The soldering condition referring to J-STD-020B. The storage ambient for the LEDs should not exceed 30°C temperature or 70% relative humidity. It is recommended that LEDs out of their original packaging are soldered within one week. For extended storage out of their original packaging, it is recommended that the LEDs were stored in a sealed container with appropriate desiccant, or desiccators with nitrogen ambient. If the LEDs were unpacked more than 168hrs, baking the LEDs at 60°C for 24hrs before soldering process.
4. The soldering profile could be further referred to different soldering grease material characteristic. The grease vendor will provide this information.
5. A rapid-rate process is not recommended for the LEDs cooling down from the peak temperature.
6. Although the recommended reflow conditions are specified above, the reflow or hand soldering condition at the lowest possible temperature is desirable for the LEDs.
7. LiteOn cannot make a guarantee on the LEDs which have been already assembled using the dip soldering method.

LED HIGH POWER C03 UV Product Series

8. Reliability Test Plan

■ LTPL-C034UVHXXX

No	Test item	Condition	Duration	Number of Failed
1	Low Temperature Operating Life (LTOL)	Tc=-10°C, IF=500mA DC	1K hrs	0/10
2	Room Temperature Operating Life (RTOL)	25°C, IF=700mA	1K hrs	0/10
3	High Temperature Operating Life (HTOL)	Tc=85°C, IF=60mA DC	1K hrs	0/10
4	Wet High Temperature Operating Life (WHTOL)	60°C/90%RH, IF=350mA	500 hrs	0/10
5	Non-Operating Thermal Shock (TMSK)	-40°C to 125°C 30minutes dwell, <10 seconds transfer measure each 250 cycles (continues to fail, more than 1k cycles)	200 cycles	0/10
6	High temperature storage	T _A =100°C	1K hrs	0/10

Notes:

1. Operating life test are mounted on thermal heat sink
2. Storage item are only component, not put on heat sink.

Criteria for Judging the Damage

Item	Symbol	Test Condition	Criteria for Judgment	
			Min.	Max.
Forward Voltage	V _f	IF=Typical Current	-10%	+10%
Luminous Flux	mW	IF=Typical Current	-15%	+15%

LED HIGH POWER C03 UV Product Series

9. Package Dimension of Tape and Reel

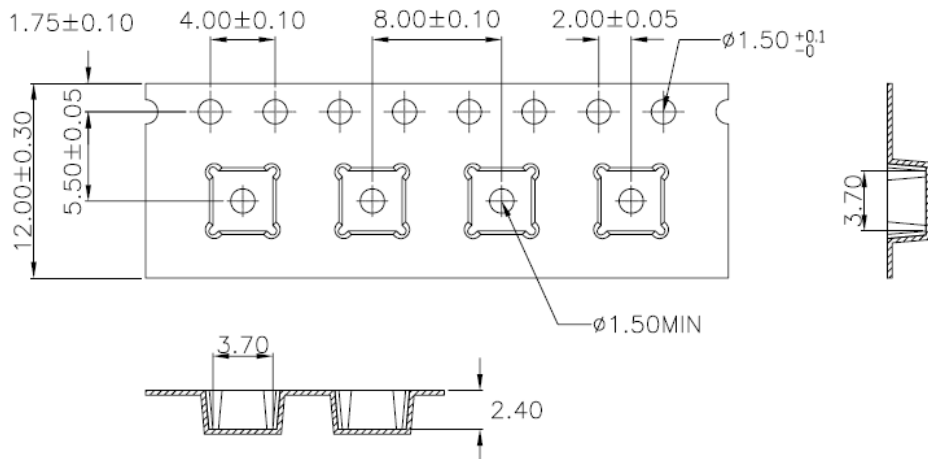

Package Dimensions of Reel

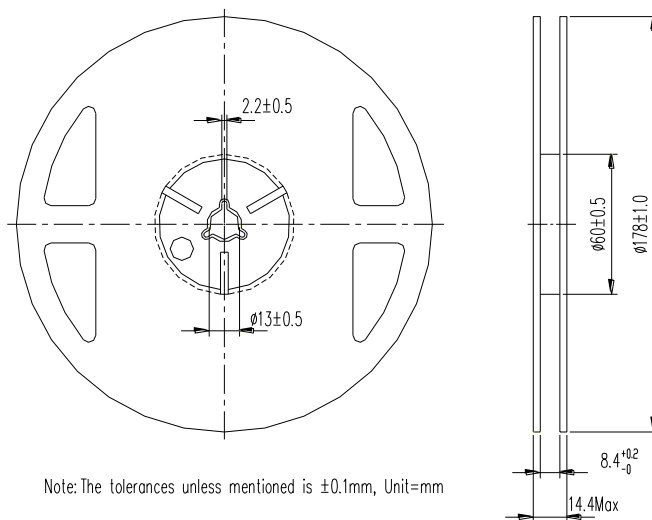

Notes:

1. Empty component pockets sealed with top cover tape.
2. 7 inch reel-700 pieces per reel.
3. Minimum packing quantity is 250 pieces for remainders.
4. The maximum number of consecutive missing lamps is two.
5. In accordance with EIA-481-1-B specifications.

LED HIGH POWER C03 UV Product Series

10. Cautions

10.1 An LED is a current-operated device. In order to ensure intensity uniformity on multiple LEDs connected in parallel in an application, it is recommended that a current limiting resistor be incorporated in the drive circuit, in series with each LED as shown in Circuit below.

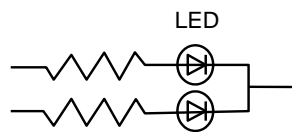

Circuit model A

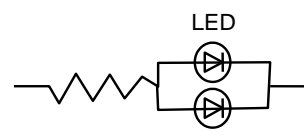

Circuit model B

(A) Recommended circuit.

(B) The brightness of each LED might appear different due to the differences in the I-V characteristics of those LEDs.

(C) This LED should be used under forward current, particularly not used under continuous reverse current to avoid the damage to LED.

10.2 The electrode pads are plated with gold, but it is still not recommended to the use under any of the following conditions, please confirm the performance and reliability are well enough if you use it under any of the following conditions

- Do not use sulfur-containing materials in commercial products including the materials such as seals and adhesives that may contain sulfur.
- Do not put this product in a place with a lot of moisture (over 85% relative humidity), dew condensation, briny air, and corrosive gas (Cl, H₂S, NH₃, SO₂, NO_x, etc.).

10.3 Manual Handling Remark

The LED should only be picked up by making contact with the sides of the LED body. It should not put any pressure on the lens either by finger or any hand tool. Do not puncture or push the lens. Below figure illustrate correct and incorrect handling.

10.4 Safety

Do NOT directly look at the UV light from LED or optical instrument because it is harmful to human eyes. And it is recommended to use UV goggles protective glasses for avoiding eye damage.

10.5 ESD (Electrostatic Discharge)

Static Electricity or power surge will damage the LED. Suggestions to prevent ESD damage:

- Use a conductive wrist band or anti-electrostatic glove when handling these LEDs.
- All devices, equipment, and machinery must be properly grounded.
- Work tables, storage racks, etc. should be properly grounded.
- Use ion blower to neutralize the static charge which might have built up on surface of the LED's plastic lens as a result of friction between LEDs during storage and handling.

ESD-damaged LEDs will exhibit abnormal characteristics such as high reverse leakage current, low forward voltage, or "no light up" at low currents. To verify for ESD damage, check for "light up" and V_F of the suspect LEDs at low currents. The V_F of "good" LEDs should be $>2.0V@0.5mA$.

Training and Certification

1. Working area is ESD-certified.
2. Training records and re-certification dates monitored.

Static-Safe Workstation & Work Areas

1. Static-safe working stations or work-areas have ESD signs.
2. All surfaces and objects at all static-safe workstation and within 1 ft measure less than 100V.
3. All ionizer activated, positioned towards the units.
4. Each work surface mats grounding is good.

Personnel Grounding

1. Every person (including visitors) handling ESD sensitive (ESDS) items wear wrist strap, heel strap or conductive shoes with conductive flooring.
2. If conductive footwear used, conductive flooring also present.
3. Garments, hairs or anything closer than 1 ft to ESD items measure less than 100V.
4. The wrist strap or heel strap/conductive shoes are checked daily and result recorded.
5. All wrist strap or heel strap checkers calibration up to date.

Device Handling

1. Each ESDS items identified by EIA-471 labels on item or packaging..
2. No static charge generators (e.g. plastics) inside shielding containers with ESDS items.
3. All flexible conductive and dissipative package materials are inspected before reuse or recycles

LED HIGH POWER C03 UV Product Series

10.6 Storage

Before opening aluminum bag, the storage ambient for the LEDs should not exceed 30°C temperature or 85% relative humidity.

After opening aluminum bag, the storage ambient for the LEDs should not exceed 30°C temperature or 70% relative humidity.

It is recommended that LEDs out of their original packaging are soldered within one week.

For extended storage out of their original packaging, it is recommended that the LEDs were stored in a sealed container with appropriate desiccant, or a desiccators with nitrogen ambient. LEDs stored out of their original packaging for more than a week should be baked at about 60°C for at least 24 hours before solder assembly.

**LED HIGH POWER
C03 UV Product Series**

11. Revision history

Version	Revised date	Summary of change
3.1	April 15, 2015	Initial specification
3.3	July 17, 2015	Create new P/N of LTPL-C034UVH405
3.4	July 23, 2015	Description of pin definition Update Vf of LTPL-C034UVH365