

Generation 4

Sensus™ LED Series

Pure White Targeted COB Arrays Below the Black Body Locus (BBBL)



Contents

Part Number Nomenclature 2

CCT, CRI & R9 Specification . . 2

Chromaticity Bin Structure . 3

Ordering Part Numbers 4

Operating Characteristics . . 9

Optical and Electrical Characteristics 15

Typical Spectrum 32

Radiation Pattern 32

Mechanical Dimension . . . 33

Shipping Container 33

Label Information 38

Technology Review 39

Test Specifications 39

Handling Notes 40

Features:

- Matching the human perception of “Pure white” light
- Designed to provide the look and feel of ceramic metal halide lights
- Wide product range from 1,000lm to over 15,000lm
- 2700K, 3000K and 3500K, 80 and 90CRI standard
- Highly saturated color rendering version in 2700K, 3000K and 3500K
- 3 SDCM color binning standard, 2 SDCM binning available
- Excellent optical emission uniformity and color over angle consistency
- Exceptional long term color stability
- Superior thermal conductivity for uniform heat spreading
- Environmentally friendly: RoHS and REACH compliant
- UL recognized, file # E465703



Applications

- Spotlights/Track Lights
- Downlights
- Shop Lighting
- Hospitality Lighting
- Architectural and Specialty
- Street Lighting
- Parking Lot and Area Lighting
- Tunnel Lighting

Part Number Nomenclature

All Luminus COB products are packaged and labeled with part numbers as outlined in the table on page 4. Luminus may include any smaller chromaticity bin that is contained in the larger bin as part of the ordered part. When shipped, each package will contain only a single flux and chromaticity bin. The part number designation is as follows:

Product Family	LES ¹	CCT ²	Min. CRI ³	Typical Voltage	Package Configurator ⁴	Flux Bin	Chromaticity Bin
CIM/CLM/ CXM/CGM Chip on Board Multi-die	Approximate LES diameter	See Note 2 below	CRI See Table Below	Volts (V)	AC42	Lumens	See page 3 for bins

Notes:

1. Light Emitting Surface (LES) Diameter corresponding to the following:

- 6 = 6.3mm
- 9 = 9.8mm
- 11 = 11.6mm
- 14 = 14.5mm
- 18 = 17.5mm
- 22 = 22.0mm
- 32 = 32.8 mm

2. Correlated Color Temperature (CCT), NN nomenclature corresponds to the following:

- 27 = 2700K
- 30 = 3000K
- 35 = 3500K

3. Minimum Color Rendering Index (CRI).

4. AC is a standard substrate size, AA is an alternative; 4 means Generation 4 COB products; 2 means Sensus products, 4 means Xtreme Sensus products.

5. Luminus part numbers may be accompanied by prefixes or suffixes. The most common is the "Rev01" suffix indicating a part is fully released and carries a full warranty. These additional characters may appear on shipping labels, packing slips and invoices. In all cases the basic part number described above will always be included.

CCT, CRI and R9 Values

Correlated Color Temperatures	XX Value	CRI	*R9
3000K	80	>80	>0
2700K, 3000K, 3500K	90	>90	>50

Note: R9 values have a tolerance of +/- 5%

Chromaticity Bin Structure

Chromaticity Bins: 1931 CIE Color Space

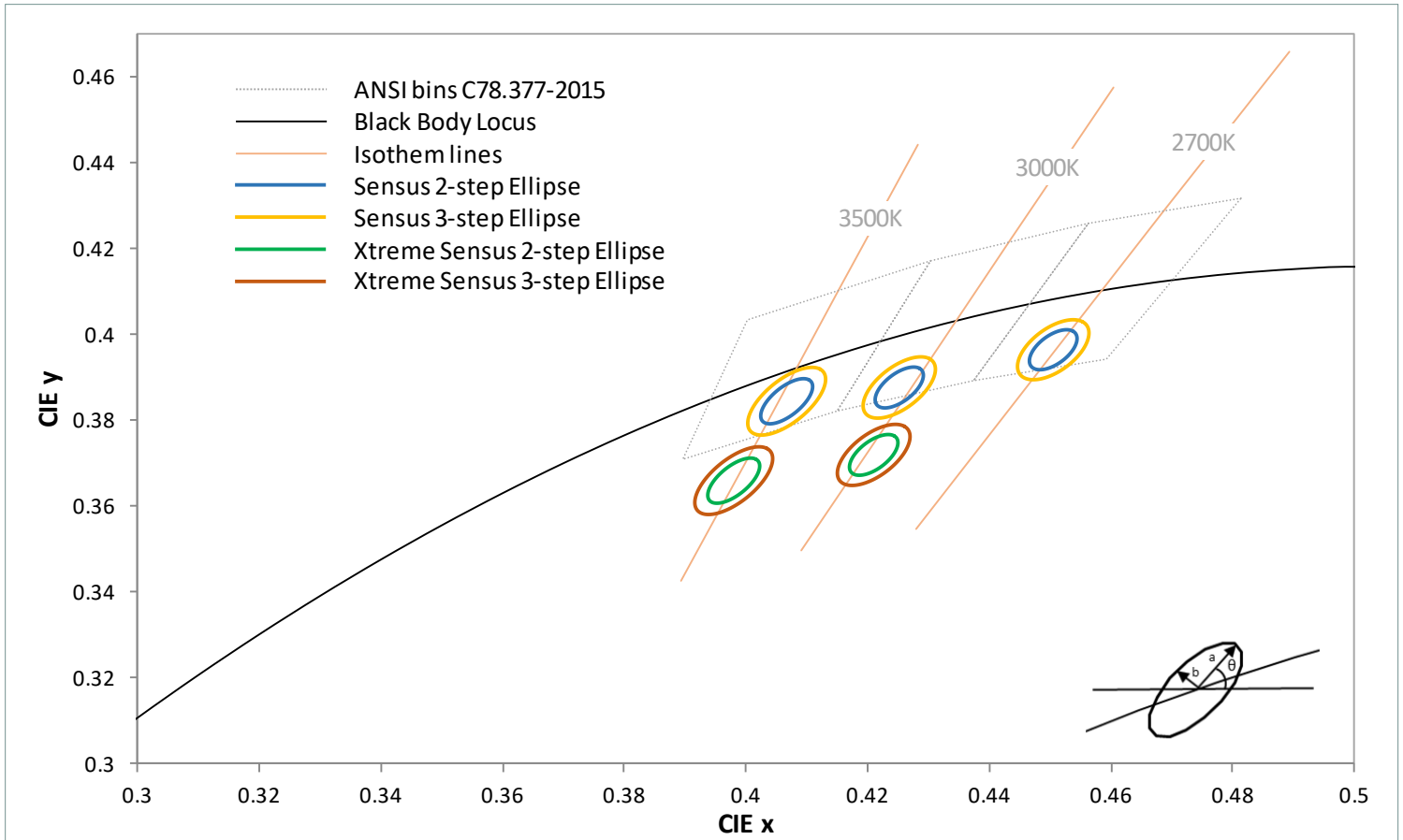

The following tables describe the chromaticity bin center points, the orientation angle for the MacAdam ellipse (θ°), and the maximum radii for the ellipses. The ANSI Bin is provided for reference.

Description	CCT	Center Point		Angle θ°	3-step Bin		2-step Bin	
		CIE _x	CIE _y		a	b	a	b
Sensus	2700K	0.4505	0.3965	53.7	0.0081	0.0042	0.0054	0.0028
	3000K	0.4252	0.3877	53.6	0.00834	0.00408	0.00556	0.00272
	3500K	0.4067	0.3845	54.0	0.00927	0.00414	0.00618	0.00276
Xtreme Sensus	3000K	0.4210	0.3720	53.2	0.00834	0.00408	0.00556	0.00272
	3500K	0.3980	0.3660	54.0	0.00927	0.00414	0.00618	0.00276

Note: Luminus maintains a +/- 0.005 tolerance on chromaticity (CIE_x and CIE_y) measurements

Ordering Part Numbers - Sensus

The following tables describe products with typical flux and minimum flux measured at typical current and specified at $T_j = 85^\circ\text{C}$. The values at 25°C are calculated and shown for reference only.

Output Flux (lm)			LES Diameter (mm)	Typ. Current (mA)	Ordering Part Number	
Typ. (85°C)	Min. (85°C)	Calculated Typ. (25°C)			3-step MacAdam Ellipse	2-step MacAdam Ellipse
600	560	640	6.3	300	CXM-6-27-90-18-AC42-F5-3	CXM-6-27-90-18-AC42-F5-2
740	690	790			CXM-6-30-80-18-AC42-F5-3	CXM-6-30-80-18-AC42-F5-2
655	610	700			CXM-6-30-90-18-AC42-F5-3	CXM-6-30-90-18-AC42-F5-2
680	630	730			CXM-6-35-90-18-AC42-F5-3	CXM-6-35-90-18-AC42-F5-2
600	560	640		150	CXM-6-27-90-36-AC42-F5-3	CXM-6-27-90-36-AC42-F5-2
740	690	790			CXM-6-30-80-36-AC42-F5-3	CXM-6-30-80-36-AC42-F5-2
655	610	700			CXM-6-30-90-36-AC42-F5-3	CXM-6-30-90-36-AC42-F5-2
680	630	730			CXM-6-35-90-36-AC42-F5-3	CXM-6-35-90-36-AC42-F5-2
745	695	795	9.8	360	CIM-9-27-90-18-AC42-F5-3	CIM-9-27-90-18-AC42-F5-2
915	850	980			CIM-9-30-80-18-AC42-F5-3	CIM-9-30-80-18-AC42-F5-2
810	755	865			CIM-9-30-90-18-AC42-F5-3	CIM-9-30-90-18-AC42-F5-2
845	785	905			CIM-9-35-90-18-AC42-F5-3	CIM-9-35-90-18-AC42-F5-2
745	695	795		180	CIM-9-27-90-36-AC42-F5-3	CIM-9-27-90-36-AC42-F5-2
915	850	980			CIM-9-30-80-36-AC42-F5-3	CIM-9-30-80-36-AC42-F5-2
810	755	865			CIM-9-30-90-36-AC42-F5-3	CIM-9-30-90-36-AC42-F5-2
845	785	905			CIM-9-35-90-36-AC42-F5-3	CIM-9-35-90-36-AC42-F5-2
1,000	930	1,070	9.8	250	CLM-9-27-90-36-AC42-F5-3	CLM-9-27-90-36-AC42-F5-2
1,235	1,150	1,320			CLM-9-30-80-36-AC42-F5-3	CLM-9-30-80-36-AC42-F5-2
1,095	1,020	1,170			CLM-9-30-90-36-AC42-F5-3	CLM-9-30-90-36-AC42-F5-2
1,135	1,055	1,215			CLM-9-35-90-36-AC42-F5-3	CLM-9-35-90-36-AC42-F5-2
1,415	1,315	1,515	9.8	360	CXM-9-27-90-36-AA42-F5-3	CXM-9-27-90-36-AA42-F5-2
1,745	1,625	1,865			CXM-9-30-80-36-AA42-F5-3	CXM-9-30-80-36-AA42-F5-2
1,550	1,440	1,660			CXM-9-30-90-36-AA42-F5-3	CXM-9-30-90-36-AA42-F5-2
1,610	1,495	1,725			CXM-9-35-90-36-AA42-F5-3	CXM-9-35-90-36-AA42-F5-2
1,415	1,315	1,515			CXM-9-27-90-36-AC42-F5-3	CXM-9-27-90-36-AC42-F5-2
1,745	1,625	1,865			CXM-9-30-80-36-AC42-F5-3	CXM-9-30-80-36-AC42-F5-2
1,550	1,440	1,660			CXM-9-30-90-36-AC42-F5-3	CXM-9-30-90-36-AC42-F5-2
1,610	1,495	1,725			CXM-9-35-90-36-AC42-F5-3	CXM-9-35-90-36-AC42-F5-2

Note: Luminus maintains a +/- 6% tolerance on flux measurements.
Luminus maintains a +/- 2% tolerance on CRI measurements.

Ordering Part Numbers - Sensus

The following tables describe products with typical flux and minimum flux measured at typical current and specified at $T_j = 85^\circ\text{C}$. The values at 25°C are calculated and shown for reference only.

Output Flux (lm)			LES Diameter (mm)	Typ. Current (mA)	Ordering Part Number	
Typ. (85°C)	Min. (85°C)	Calculated Typ. (25°C)			3-step MacAdam Ellipse	2-step MacAdam Ellipse
1,825	1,695	1,955	11.6	450	CXM-11-27-90-36-AA42-F5-3	CXM-11-27-90-36-AA42-F5-2
2,250	2,095	2,410			CXM-11-30-80-36-AA42-F5-3	CXM-11-30-80-36-AA42-F5-2
1,995	1,855	2,135			CXM-11-30-90-36-AA42-F5-3	CXM-11-30-90-36-AA42-F5-2
2,075	1,930	2,220			CXM-11-35-90-36-AA42-F5-3	CXM-11-35-90-36-AA42-F5-2
1,870	1,740	2,000	14.5	450	CIM-14-27-90-36-AC42-F5-3	CIM-14-27-90-36-AC42-F5-2
2,305	2,145	2,465			CIM-14-30-80-36-AC42-F5-3	CIM-14-30-80-36-AC42-F5-2
2,045	1,900	2,190			CIM-14-30-90-36-AC42-F5-3	CIM-14-30-90-36-AC42-F5-2
2,125	1,975	2,275			CIM-14-35-90-36-AC42-F5-3	CIM-14-35-90-36-AC42-F5-2
2,075	1,930	2,220	14.5	500	CLM-14-27-90-36-AC42-F5-3	CLM-14-27-90-36-AC42-F5-2
2,560	2,380	2,740			CLM-14-30-80-36-AC42-F5-3	CLM-14-30-80-36-AC42-F5-2
2,270	2,110	2,430			CLM-14-30-90-36-AC42-F5-3	CLM-14-30-90-36-AC42-F5-2
2,360	2,195	2,525			CLM-14-35-90-36-AC42-F5-3	CLM-14-35-90-36-AC42-F5-2
2,990	2,780	3,200	14.5	720	CXM-14-27-90-36-AC42-F5-3	CXM-14-27-90-36-AC42-F5-2
3,685	3,425	3,945			CXM-14-30-80-36-AC42-F5-3	CXM-14-30-80-36-AC42-F5-2
3,265	3,035	3,495			CXM-14-30-90-36-AC42-F5-3	CXM-14-30-90-36-AC42-F5-2
3,395	3,155	3,635			CXM-14-35-90-36-AC42-F5-3	CXM-14-35-90-36-AC42-F5-2
2,990	2,780	3,200			CXM-14-27-90-36-AA42-F5-3	CXM-14-27-90-36-AA42-F5-2
3,685	3,425	3,945			CXM-14-30-80-36-AA42-F5-3	CXM-14-30-80-36-AA42-F5-2
3,265	3,035	3,495			CXM-14-30-90-36-AA42-F5-3	CXM-14-30-90-36-AA42-F5-2
3,395	3,155	3,635			CXM-14-35-90-36-AA42-F5-3	CXM-14-35-90-36-AA42-F5-2
3,595	3,345	3,845	14.5	900	CGM-14-27-90-36-AC42-F5-3	CGM-14-27-90-36-AC42-F5-2
4,435	4,125	4,745			CGM-14-30-80-36-AC42-F5-3	CGM-14-30-80-36-AC42-F5-2
3,930	3,655	4,205			CGM-14-30-90-36-AC42-F5-3	CGM-14-30-90-36-AC42-F5-2
4,085	3,800	4,370			CGM-14-35-90-36-AC42-F5-3	CGM-14-35-90-36-AC42-F5-2

Note: Luminus maintains a +/- 6% tolerance on flux measurements.
Luminus maintains a +/- 2% tolerance on CRI measurements.

Ordering Part Numbers - Sensus

The following tables describe products with typical flux and minimum flux measured at typical current and specified at $T_j = 85^\circ\text{C}$. The values at 25°C are calculated and shown for reference only.

Output Flux (lm)			LES Diameter (mm)	Typ. Current (mA)	Ordering Part Number	
Typ. (85°C)	Min. (85°C)	Calculated Typ. (25°C)			3-step MacAdam Ellipse	2-step MacAdam Ellipse
3,365	3,130	3,600	17.5	800	CXM-18-27-90-36-AA42-F5-3	CXM-18-27-90-36-AA42-F5-2
3,680	3,420	3,940			CXM-18-30-90-36-AA42-F5-3	CXM-18-30-90-36-AA42-F5-2
3,825	3,555	4,095			CXM-18-35-90-36-AA42-F5-3	CXM-18-35-90-36-AA42-F5-2
4,570	4,250	4,890	22.0	990	CIM-22-30-90-36-AC42-F5-3	CIM-22-30-90-36-AC42-F5-2
4,750	4,420	5,085			CIM-22-35-90-36-AC42-F5-3	CIM-22-35-90-36-AC42-F5-2
4,485	4,170	4,800	22.0	1050	CLM-22-27-90-36-AC42-F5-3	CLM-22-27-90-36-AC42-F5-2
4,905	4,560	5,250			CLM-22-30-90-36-AC42-F5-3	CLM-22-30-90-36-AC42-F5-2
5,095	4,740	5,450			CLM-22-35-90-36-AC42-F5-3	CLM-22-35-90-36-AC42-F5-2
7,225	6,720	7,730	22.0	1050	CXM-22-30-90-54-AC42-F5-3	CXM-22-30-90-54-AC42-F5-2
7,515	6,990	8,040			CXM-22-35-90-54-AC42-F5-3	CXM-22-35-90-54-AC42-F5-2
10,705	9,955	11,455	22.0	1600	CGM-22-30-90-54-AC42-F5-3	CGM-22-30-90-54-AC42-F5-2
11,130	10,350	11,910			CGM-22-35-90-54-AC42-F5-3	CGM-22-35-90-54-AC42-F5-2
16,190	15,055	17,325	32.8	2400	CXM-32-30-90-54-AC42-F5-3	CXM-32-30-90-54-AC42-F5-2
16,830	15,650	18,010			CXM-32-35-90-54-AC42-F5-3	CXM-32-35-90-54-AC42-F5-2

Note: Luminus maintains a +/- 6% tolerance on flux measurements.
Luminus maintains a +/- 2% tolerance on CRI measurements.

Ordering Part Numbers - Xtreme Sensus

The following tables describe products with typical flux and minimum flux measured at typical current and specified at $T_j = 85^\circ\text{C}$. The values at 25°C are calculated and shown for reference only.

Output Flux (lm)			LES Diameter (mm)	Typ. Current (mA)	Ordering Part Number	
Typ. (85°C)	Min. (85°C)	Calculated Typ. (25°C)			3-step MacAdam Ellipse	2-step MacAdam Ellipse
600	560	640	6.3	300	CXM-6-30-90-18-AC44-F5-3	CXM-6-30-90-18-AC44-F5-2
620	575	665			CXM-6-35-90-18-AC44-F5-3	CXM-6-35-90-18-AC44-F5-2
600	560	640		150	CXM-6-30-90-36-AC44-F5-3	CXM-6-30-90-36-AC44-F5-2
620	575	665			CXM-6-35-90-36-AC44-F5-3	CXM-6-35-90-36-AC44-F5-2
745	695	795	9.8	360	CIM-9-30-90-36-AC44-F5-3	CIM-9-30-90-36-AC44-F5-2
770	715	825			CIM-9-35-90-36-AC44-F5-3	CIM-9-35-90-36-AC44-F5-2
745	695	795		180	CIM-9-30-90-18-AC44-F5-3	CIM-9-30-90-18-AC44-F5-2
770	715	825			CIM-9-35-90-18-AC44-F5-3	CIM-9-35-90-18-AC44-F5-2
1,000	930	1,070	9.8	250	CLM-9-30-90-36-AC44-F5-3	CLM-9-30-90-36-AC44-F5-2
1,035	965	1,105			CLM-9-35-90-36-AC44-F5-3	CLM-9-35-90-36-AC44-F5-2
1,420	1,320	1,520	9.8	360	CXM-9-30-90-36-AA44-F5-3	CXM-9-30-90-36-AA44-F5-2
1,470	1,365	1,575			CXM-9-35-90-36-AA44-F5-3	CXM-9-35-90-36-AA44-F5-2
1,420	1,320	1,520			CXM-9-30-90-36-AC44-F5-3	CXM-9-30-90-36-AC44-F5-2
1,470	1,365	1,575			CXM-9-35-90-36-AC44-F5-3	CXM-9-35-90-36-AC44-F5-2
1,830	1,700	1,960	11.6	450	CXM-11-30-90-36-AA44-F5-3	CXM-11-30-90-36-AA44-F5-2
1,890	1,760	2,020			CXM-11-35-90-36-AA44-F5-3	CXM-11-35-90-36-AA44-F5-2
1,875	1,745	2,005	14.5	450	CIM-14-30-90-36-AC44-F5-3	CIM-14-30-90-36-AC44-F5-2
1,940	1,805	2,075			CIM-14-35-90-36-AC44-F5-3	CIM-14-35-90-36-AC44-F5-2
2,080	1,935	2,225	14.5	500	CLM-14-30-90-36-AC44-F5-3	CLM-14-30-90-36-AC44-F5-2
2,150	2,000	2,300			CLM-14-35-90-36-AC44-F5-3	CLM-14-35-90-36-AC44-F5-2
2,995	2,785	3,205	14.5	720	CXM-14-30-90-36-AC44-F5-3	CXM-14-30-90-36-AC44-F5-2
3,100	2,885	3,315			CXM-14-35-90-36-AC44-F5-3	CXM-14-35-90-36-AC44-F5-2
2,995	2,785	3,205			CXM-14-30-90-36-AA44-F5-3	CXM-14-30-90-36-AA44-F5-2
3,100	2,885	3,315			CXM-14-35-90-36-AA44-F5-3	CXM-14-35-90-36-AA44-F5-2
3,600	3,350	3,850	14.5	900	CGM-14-30-90-36-AC44-F5-3	CGM-14-30-90-36-AC44-F5-2
3,725	3,465	3,985			CGM-14-35-90-36-AC44-F5-3	CGM-14-35-90-36-AC44-F5-2

Note: Luminus maintains a +/- 6% tolerance on flux measurements.
Luminus maintains a +/- 2% tolerance on CRI measurements.

Ordering Part Numbers - Xtreme Sensus

The following tables describe products with typical flux and minimum flux measured at typical current and specified at $T_j = 85^\circ\text{C}$. The values at 25°C are calculated and shown for reference only.

Output Flux (lm)			LES Diameter (mm)	Typ. Current (mA)	Ordering Part Number	
Typ. (85°C)	Min. (85°C)	Calculated Typ. (25°C)			3-step MacAdam Ellipse	2-step MacAdam Ellipse
3,375	3,140	3,610	17.5	800	CXM-18-30-90-36-AA44-F5-3	CXM-18-30-90-36-AA44-F5-2
3,490	3,245	3,735			CXM-18-35-90-36-AA44-F5-3	CXM-18-35-90-36-AA44-F5-2
4,190	3,895	4,485	22.0	990	CIM-22-30-90-36-AC44-F5-3	CIM-22-30-90-36-AC44-F5-2
4,330	4,025	4,635			CIM-22-35-90-36-AC44-F5-3	CIM-22-35-90-36-AC44-F5-2
4,495	4,180	4,810	22.0	1050	CLM-22-30-90-36-AC44-F5-3	CLM-22-30-90-36-AC44-F5-2
4,650	4,325	4,975			CLM-22-35-90-36-AC44-F5-3	CLM-22-35-90-36-AC44-F5-2
6,625	6,160	7,090	22.0	1050	CXM-22-30-90-54-AC44-F5-3	CXM-22-30-90-54-AC44-F5-2
6,850	6,370	7,330			CXM-22-35-90-54-AC44-F5-3	CXM-22-35-90-54-AC44-F5-2
9,815	9,130	10,500	22.0	1600	CGM-22-30-90-54-AC44-F5-3	CGM-22-30-90-54-AC44-F5-2
10,150	9,440	10,860			CGM-22-35-90-54-AC44-F5-3	CGM-22-35-90-54-AC44-F5-2
14,840	13,800	15,880	32.8	2400	CXM-32-30-90-54-AC44-F5-3	CXM-32-30-90-54-AC44-F5-2
15,350	14,275	16,425			CXM-32-35-90-54-AC44-F5-3	CXM-32-35-90-54-AC44-F5-2

Note: Luminus maintains a +/- 6% tolerance on flux measurements.
Luminus maintains a +/- 2% tolerance on CRI measurements.

CXM-6 Operating Characteristics¹

Parameter - 36V	Symbol	Minimum	Typical	Maximum	Unit
Forward Current ²	I_f		150	450	mA
Forward Voltage ³	V_f	31.0	33.6	37.0	V

Parameter - 18V	Symbol	Minimum	Typical	Maximum	Unit
Forward Current ²	I_f		300	900	mA
Forward Voltage ³	V_f	15.5	16.8	18.5	V

Parameter	Symbol	Minimum	Typical	Maximum	Unit
Power			5.0	17.1	W
Operating Case Temperature	T_c			120	°C
Light Emitting Surface Diameter	LES		6.3		mm
Thermal Resistance (junction-to-case)	Θ_{jc}				°C/W
Junction Temperature	T_j			140	°C
Viewing Angle			120		Degree

CIM-9 Operating Characteristics¹

Parameter - 36V	Symbol	Minimum	Typical	Maximum	Unit
Forward Current ²	I_f		180	500	mA
Forward Voltage ³	V_f	31.0	33.5	37.0	V

Parameter - 18V	Symbol	Minimum	Typical	Maximum	Unit
Forward Current ²	I_f		360	1000	mA
Forward Voltage ³	V_f	15.5	16.7	18.5	V

Parameter	Symbol	Minimum	Typical	Maximum	Unit
Power			6.1	19.9	W
Operating Case Temperature	T_c			120	°C
Light Emitting Surface Diameter	LES		9.8		mm
Thermal Resistance (junction-to-case)	Θ_{jc}		0.70		°C/W
Junction Temperature	T_j			140	°C
Viewing Angle			120		Degree

CLM-9 Operating Characteristics¹

Parameter	Symbol	Minimum	Typical	Maximum	Unit
Forward Current ²	I_f		250	900	mA
Forward Voltage ³	V_f	31.0	33.5	37.0	V
Power			8.3	34.4	W
Operating Case Temperature	T_c			120	°C
Light Emitting Surface Diameter	LES		9.8		mm
Thermal Resistance (junction-to-case)	Θ_{jc}		0.65		°C/W
Junction Temperature	T_j			140	°C
Viewing Angle			120		Degree

CXM-9 Operating Characteristics¹

Parameter	Symbol	Minimum	Typical	Maximum	Unit
Forward Current ²	I_f		360	1,100	mA
Forward Voltage ³	V_f	31.0	33.5	37.0	V
Power			12.1	41.9	W
Operating Case Temperature	T_c			120	°C
Light Emitting Surface Diameter	LES		9.8		mm
Thermal Resistance (junction-to-case)	Θ_{jc}		0.50		°C/W
Junction Temperature	T_j			140	°C
Viewing Angle			120		Degree

CXM-11 Operating Characteristics¹

Parameter	Symbol	Minimum	Typical	Maximum	Unit
Forward Current ²	I_f		450	1,300	mA
Forward Voltage ³	V_f	31.0	33.7	37.0	V
Power			15.1	49.3	W
Operating Case Temperature	T_c			120	°C
Light Emitting Surface Diameter	LES		11.6		mm
Thermal Resistance (junction-to-case)	Θ_{jc}				°C/W
Junction Temperature	T_j			140	°C
Viewing Angle			120		Degree

CIM-14 Operating Characteristics¹

Parameter	Symbol	Minimum	Typical	Maximum	Unit
Forward Current ²	I_f		450	1,300	mA
Forward Voltage ³	V_f	31.0	33.5	37.0	V
Power			15.1	49.3	W
Operating Case Temperature	T_c			120	°C
Light Emitting Surface Diameter	LES		14.5		mm
Thermal Resistance (junction-to-case)	Θ_{jc}				°C/W
Junction Temperature	T_j			140	°C
Viewing Angle			120		Degree

CLM-14 Operating Characteristics¹

Parameter	Symbol	Minimum	Typical	Maximum	Unit
Forward Current ²	I_f		500	1,800	mA
Forward Voltage ³	V_f	31.0	33.5	37.0	V
Power			16.6	68.7	W
Operating Case Temperature	T_c			120	°C
Light Emitting Surface Diameter	LES		14.5		mm
Thermal Resistance (junction-to-case)	Θ_{jc}				°C/W
Junction Temperature	T_j			140	°C
Viewing Angle			120		Degree

CXM-14 Operating Characteristics¹

Parameter	Symbol	Minimum	Typical	Maximum	Unit
Forward Current ²	I_f		720	2,000	mA
Forward Voltage ³	V_f	31.0	33.5	37.0	V
Power			24.1	75.6	W
Operating Case Temperature	T_c			120	°C
Light Emitting Surface Diameter	LES		14.5		mm
Thermal Resistance (junction-to-case)	Θ_{jc}		0.27		°C/W
Junction Temperature	T_j			140	°C
Viewing Angle			120		Degree

CGM-14 Operating Characteristics¹

Parameter	Symbol	Minimum	Typical	Maximum	Unit
Forward Current ²	I_f		900	2,300	mA
Forward Voltage ³	V_f	31.0	34.4	37.0	V
Power			30.4	86.3	W
Operating Case Temperature	T_c			120	°C
Light Emitting Surface Diameter	LES		14.5		mm
Thermal Resistance (junction-to-case)	Θ_{jc}				°C/W
Junction Temperature	T_j			140	°C
Viewing Angle			120		Degree

CXM-18 Operating Characteristics¹

Parameter	Symbol	Minimum	Typical	Maximum	Unit
Forward Current ²	I_f		800	2,500	mA
Forward Voltage ³	V_f	31.0	33.5	37.0	V
Power			26.8	93.8	W
Operating Case Temperature	T_c			120	°C
Light Emitting Surface Diameter	LES		17.5		mm
Thermal Resistance (junction-to-case)	Θ_{jc}				°C/W
Junction Temperature	T_j			140	°C
Viewing Angle			120		Degree

CIM-22 Operating Characteristics¹

Parameter	Symbol	Minimum	Typical	Maximum	Unit
Forward Current ²	I_f		990	3,000	mA
Forward Voltage ³	V_f	31.0	33.3	37.0	V
Power			33.2	112.5	W
Operating Case Temperature	T_c			120	°C
Light Emitting Surface Diameter	LES		22.0		mm
Thermal Resistance (junction-to-case)	Θ_{jc}				°C/W
Junction Temperature	T_j			140	°C
Viewing Angle			120		Degree

CLM-22 Operating Characteristics¹

Parameter	Symbol	Minimum	Typical	Maximum	Unit
Forward Current ²	I_f		1,050	3,500	mA
Forward Voltage ³	V_f	31.0	33.5	37.0	V
Power			35.2	131.3	W
Operating Case Temperature	T_c			120	°C
Light Emitting Surface Diameter	LES		22.0		mm
Thermal Resistance (junction-to-case)	Θ_{jc}				°C/W
Junction Temperature	T_j			140	°C
Viewing Angle			120		Degree

CXM-22 Operating Characteristics¹

Parameter	Symbol	Minimum	Typical	Maximum	Unit
Forward Current ²	I_f		1,050	3,500	mA
Forward Voltage ³	V_f	48.0	50.0	55.0	V
Power			52.8	198.7	W
Operating Case Temperature	T_c			120	°C
Light Emitting Surface Diameter	LES		22.0		mm
Thermal Resistance (junction-to-case)	Θ_{jc}				°C/W
Junction Temperature	T_j			140	°C
Viewing Angle			120		Degree

CGM-22 Operating Characteristics¹

Parameter	Symbol	Minimum	Typical	Maximum	Unit
Forward Current ²	I_f		1,600	4,000	mA
Forward Voltage ³	V_f	48.0	50.8	55.0	V
Power			81.1	225.7	W
Operating Case Temperature	T_c			120	°C
Light Emitting Surface Diameter	LES		22.0		mm
Thermal Resistance (junction-to-case)	Θ_{jc}				°C/W
Junction Temperature	T_j			140	°C
Viewing Angle			120		Degree

CXM-32 Operating Characteristics¹

Parameter	Symbol	Minimum	Typical	Maximum	Unit
Forward Current ²	I_f		2,400	5,000	mA
Forward Voltage ³	V_f	48.0	50.8	55.0	V
Power			122.9	284.8	W
Operating Case Temperature	T_c			120	°C
Light Emitting Surface Diameter	LES		32.8		mm
Thermal Resistance (junction-to-case)	Θ_{jc}				°C/W
Junction Temperature	T_j			140	°C
Viewing Angle			120		Degree

Notes:

1. Ratings are based on operation at a constant junction temperature of $T_j = 85^\circ\text{C}$.
2. To prevent damage refer to operating conditions and derating curves for appropriate maximum operating conditions
3. Voltage is rated at typical forward current. For voltage at higher drive current, refer to performance graphs.
4. Device operation not recommended at drive currents less than 10% of the typical value
5. Caution must be taken not to stare at the light emitted from these LEDs. Under special circumstances, the high intensity could damage the eye.
6. All product operating specifications are subject to change without advance notice.

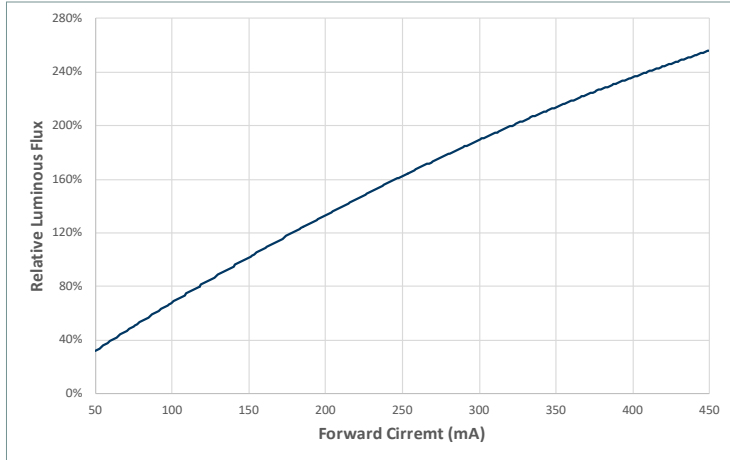
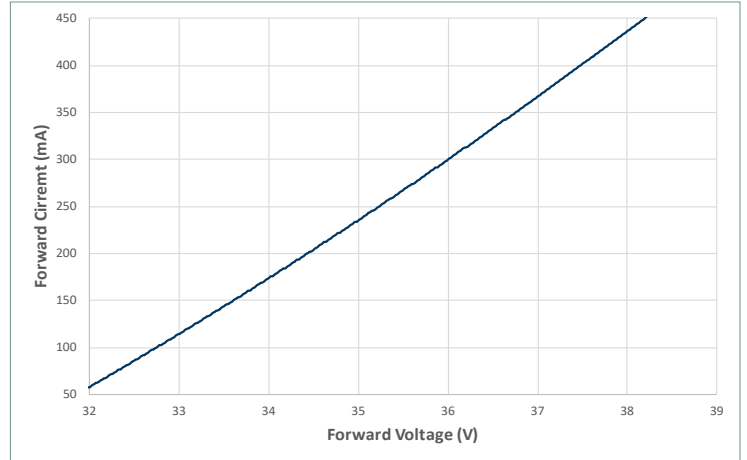
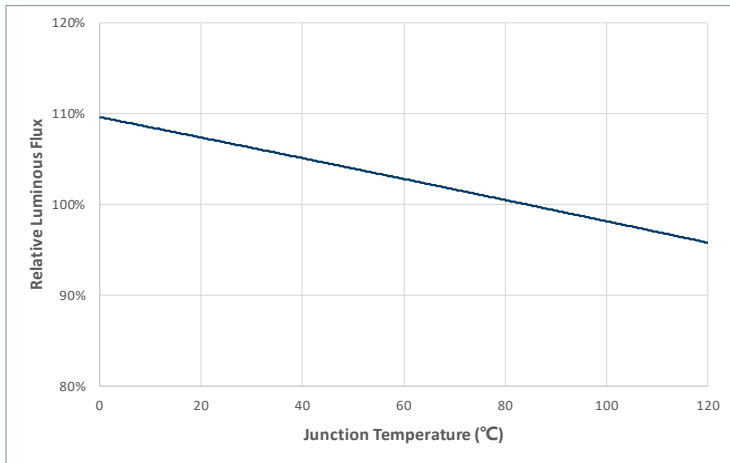
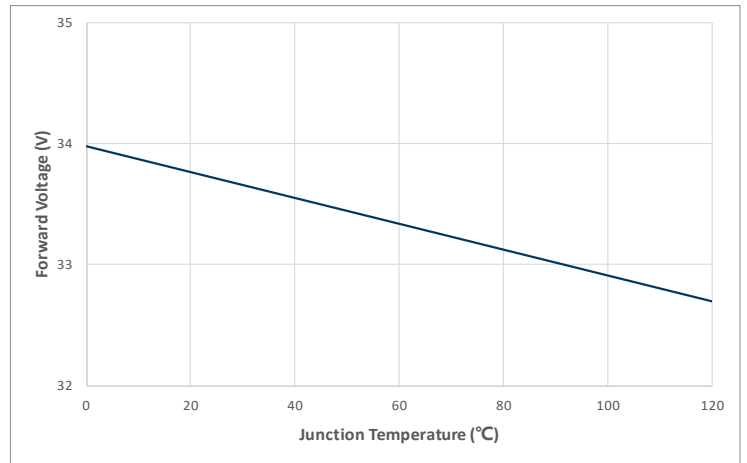
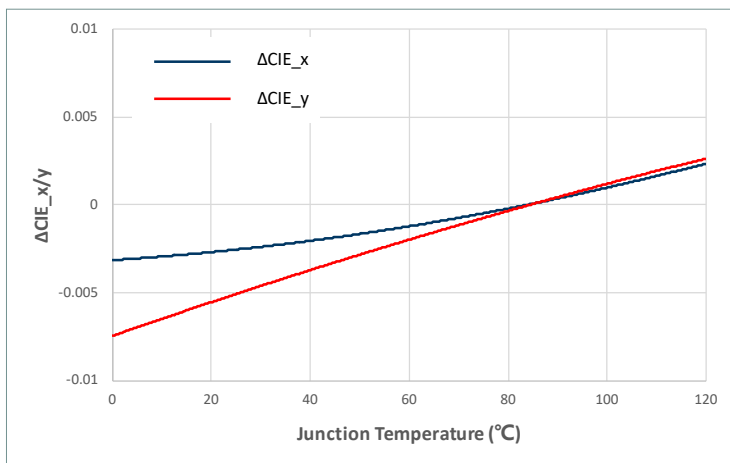
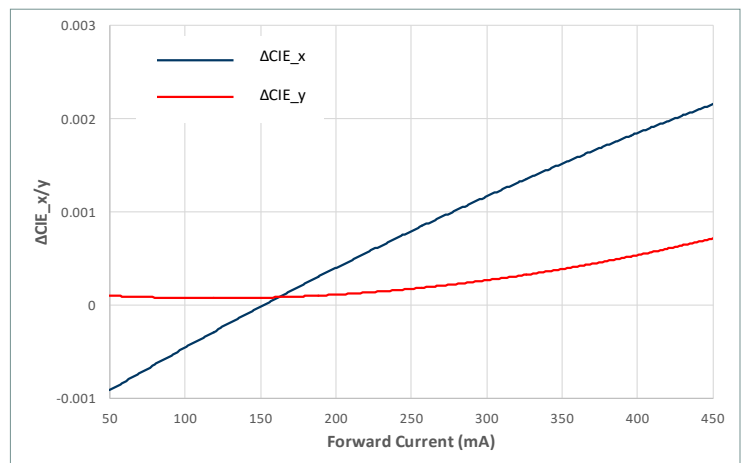
CXM-6 36V Optical & Electrical Characteristics
Relative Output Flux vs. Forward Current @ 85°C

Forward Current vs. Forward Voltage @ 85°C

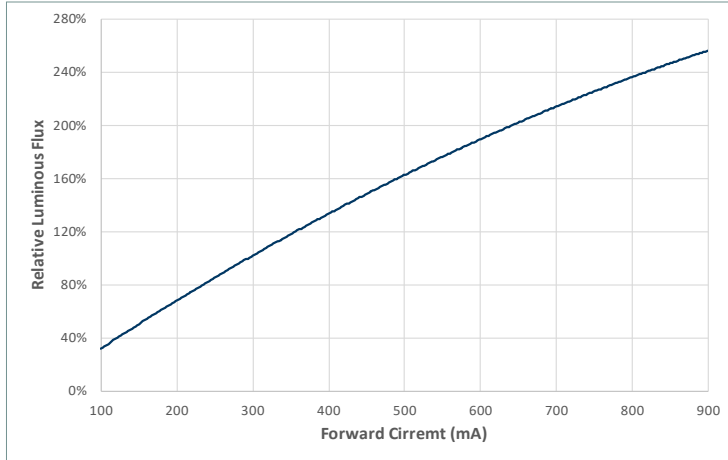
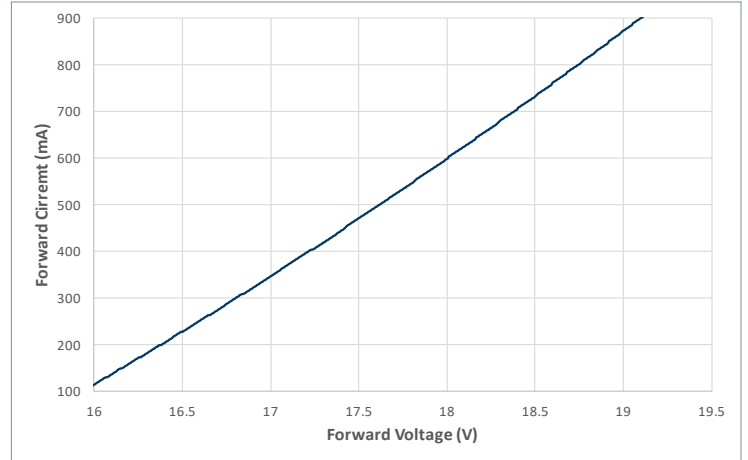
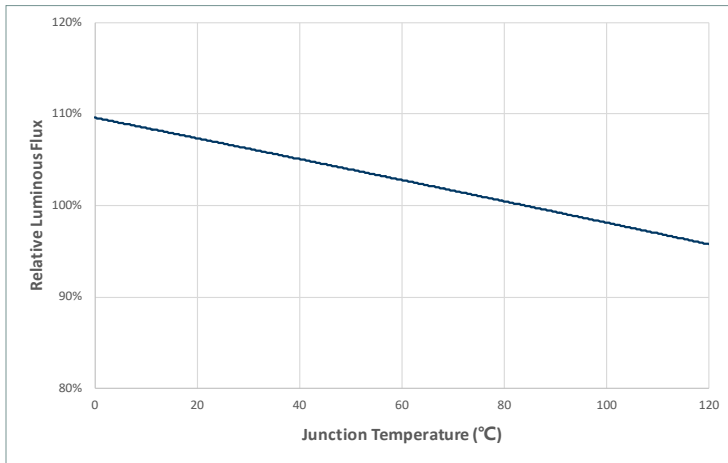
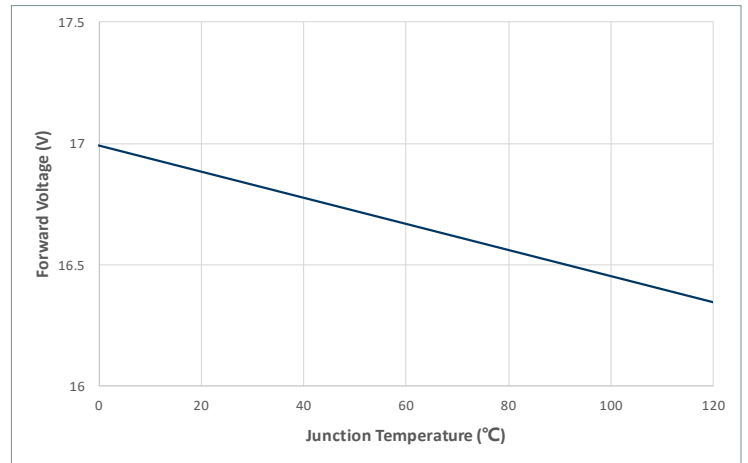
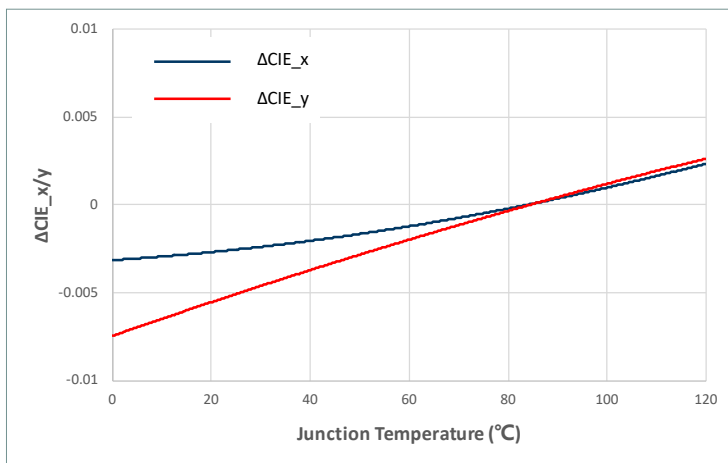
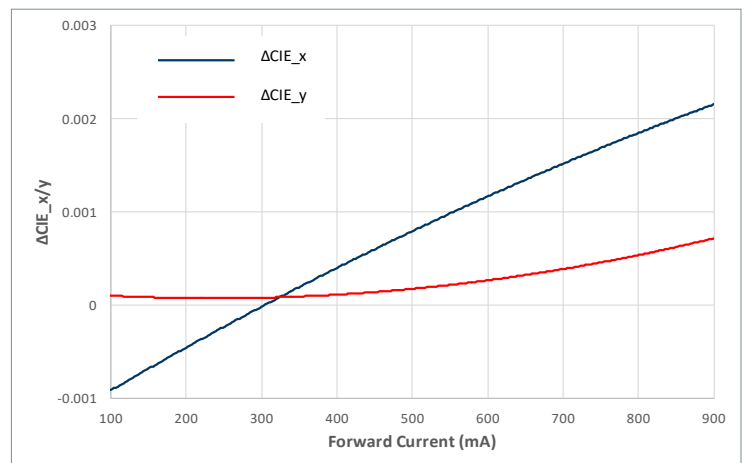
Relative Output Flux vs. Junction Temperature

Change in Voltage vs. Junction Temperature

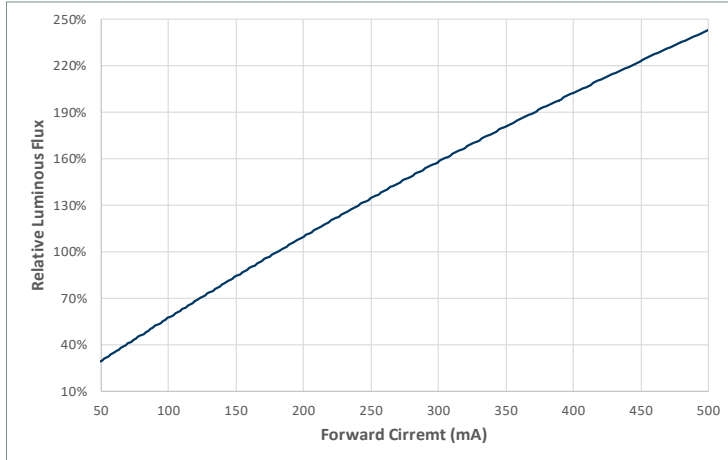
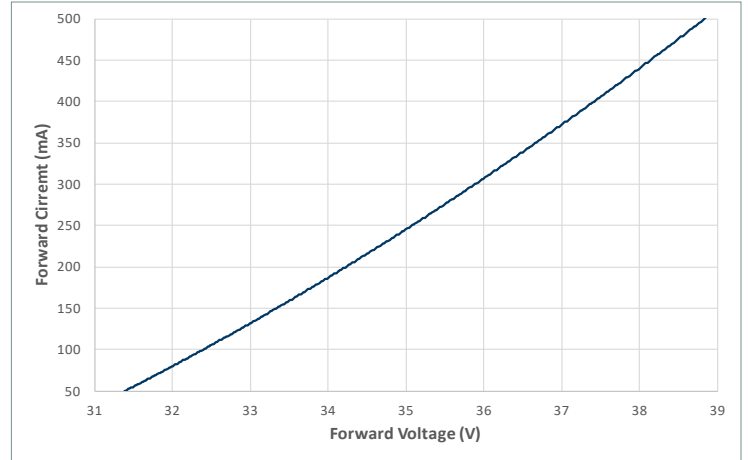
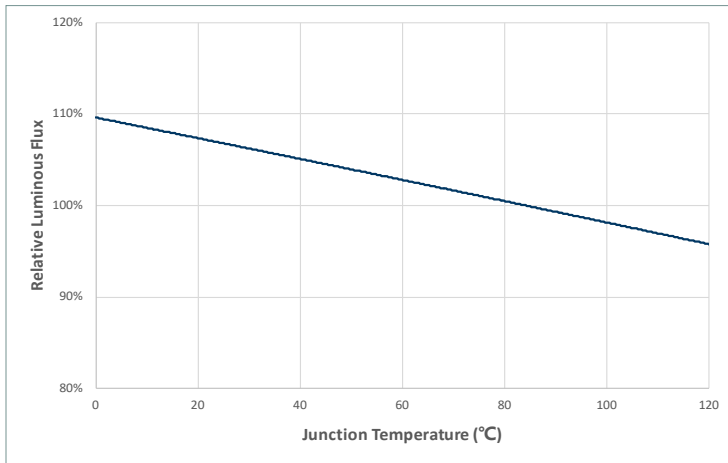
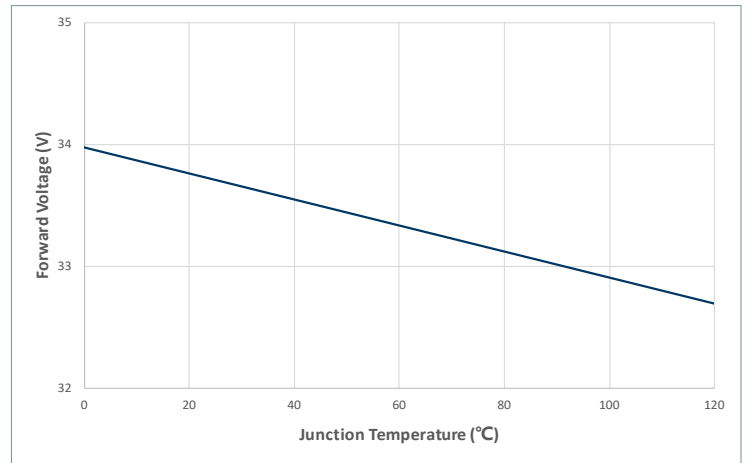
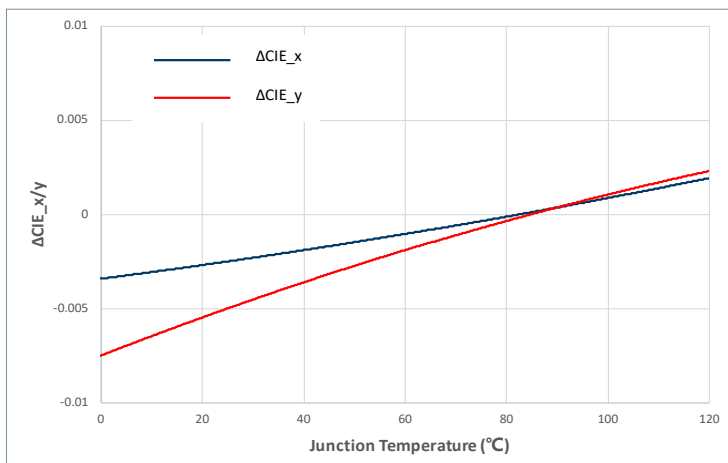
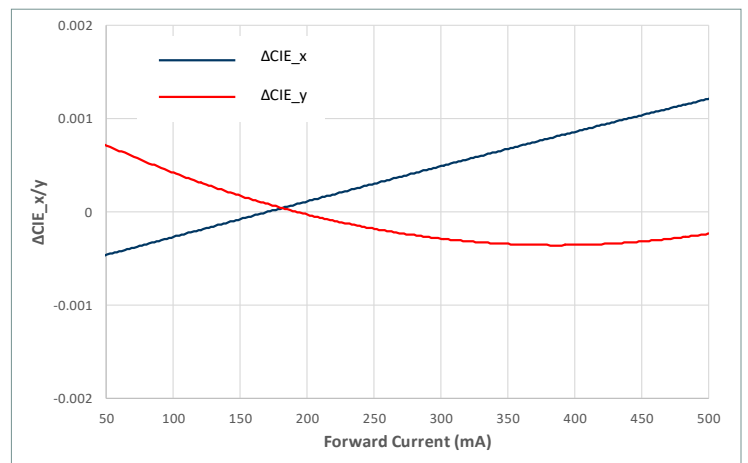
Change in CIE_x/y vs. Junction Temp. (3000K, 90CRI)

Change in CIE_x/y vs. Forward Current (3000K, 90CRI)

CXM-6 18V Optical & Electrical Characteristics

Relative Output Flux vs. Forward Current @ 85°C

Forward Current vs. Forward Voltage @ 85°C

Relative Output Flux vs. Junction Temperature

Change in Voltage vs. Junction Temperature

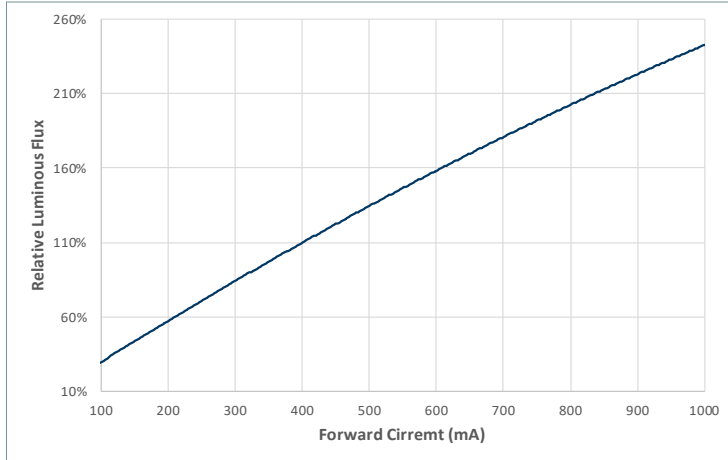
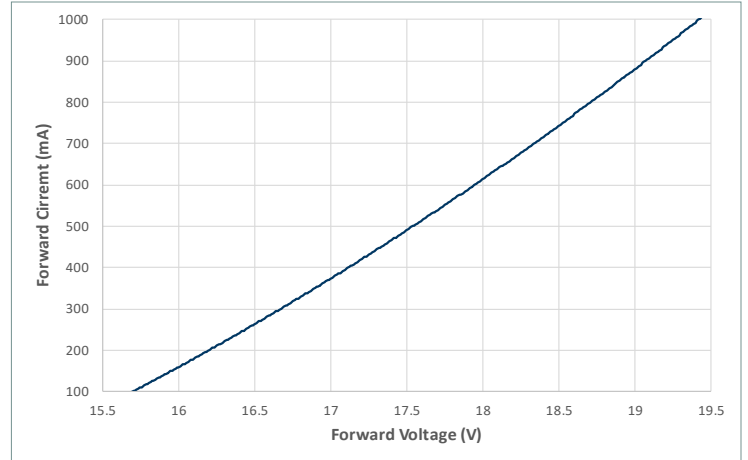
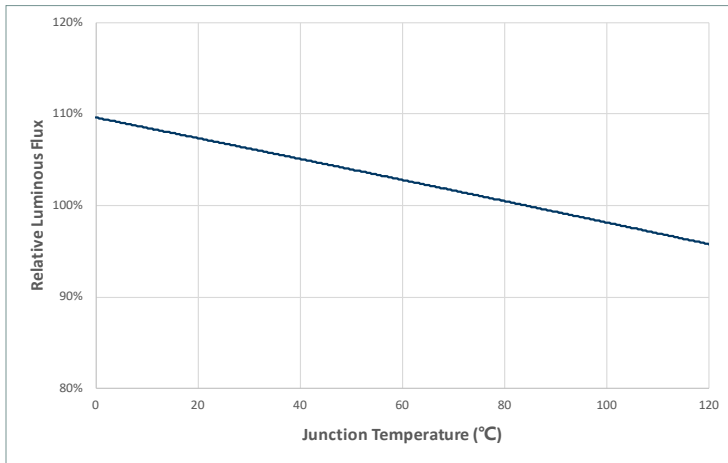
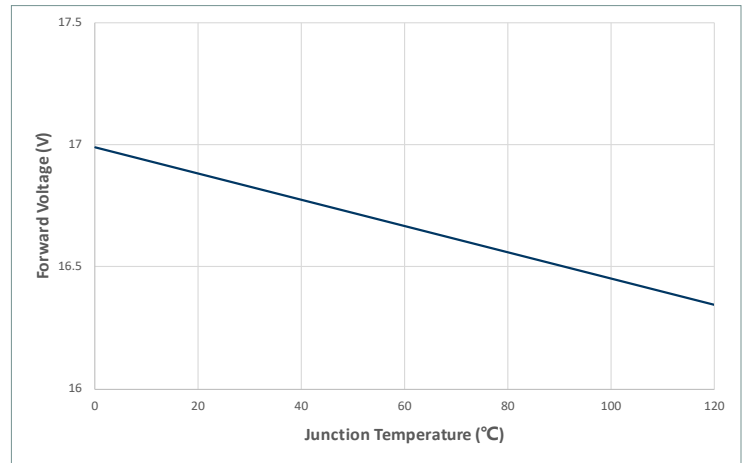
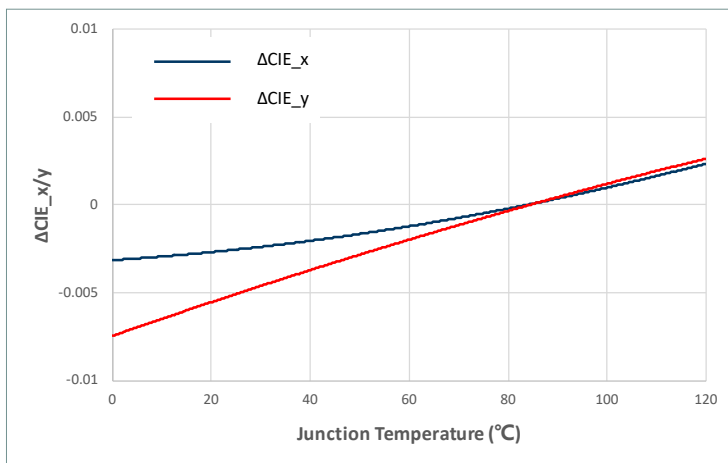
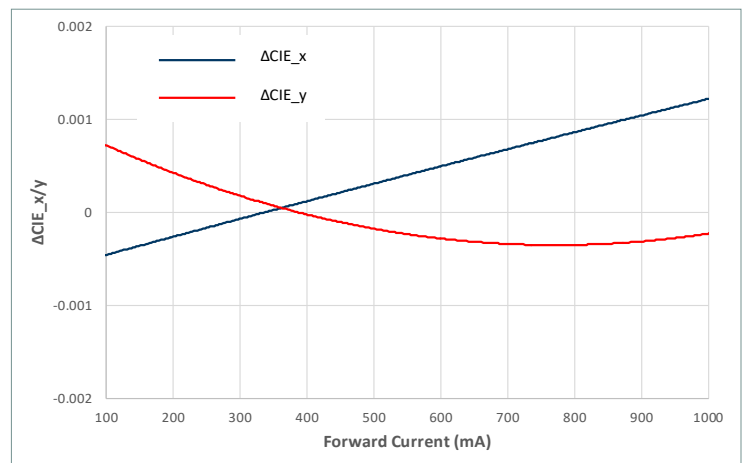
Change in CIE_x/y vs. Junction Temp. (3000K, 90CRI)

Change in CIE_x/y vs. Forward Current (3000K, 90CRI)

CIM-9 36V Optical & Electrical Characteristics

Relative Output Flux vs. Forward Current @ 85°C

Forward Current vs. Forward Voltage @ 85°C

Relative Output Flux vs. Junction Temperature

Change in Voltage vs. Junction Temperature

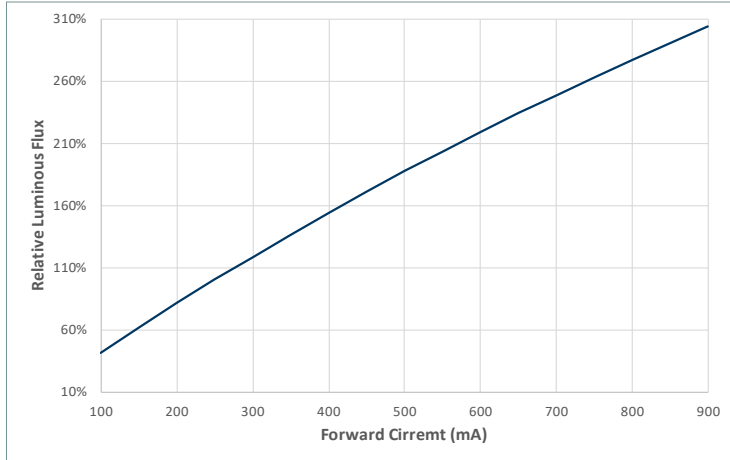
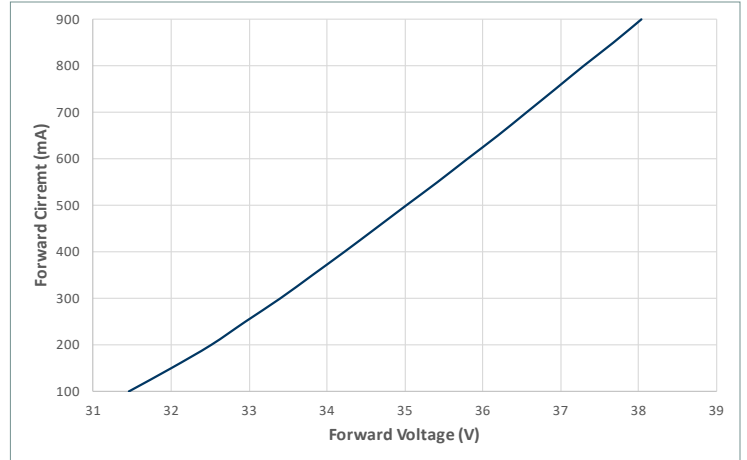
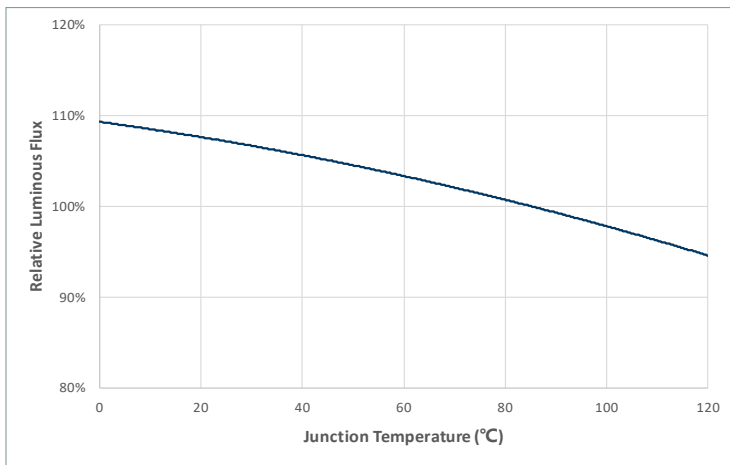
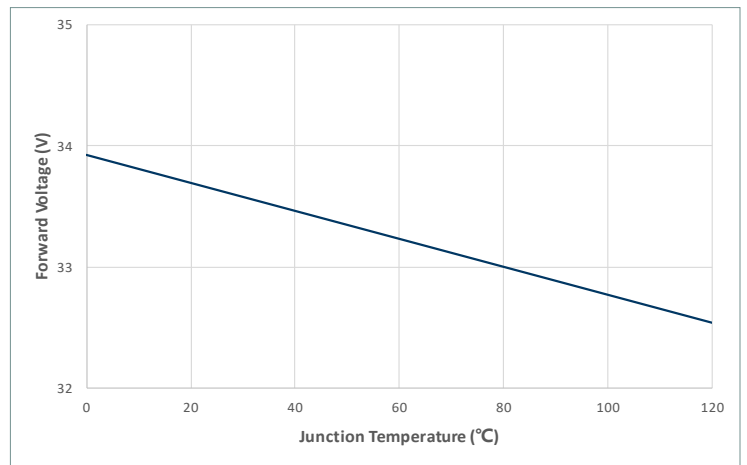
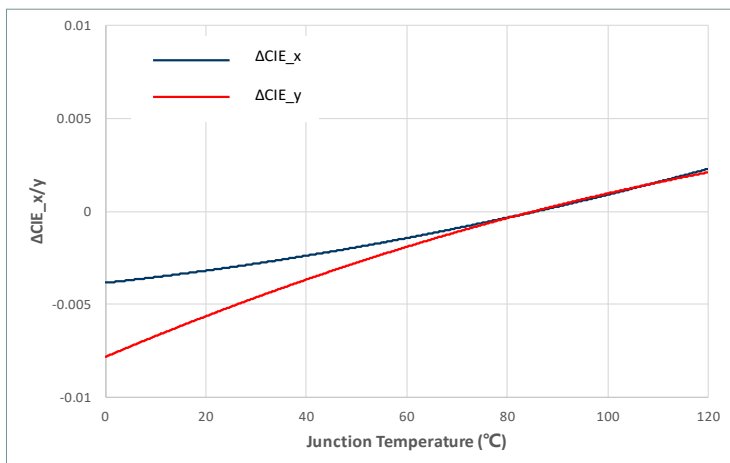
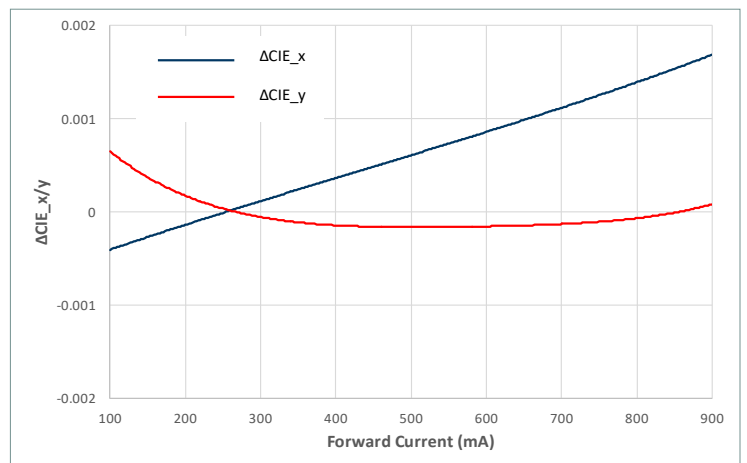
Change in CIE_x/y vs. Junction Temp. (3000K, 90CRI)

Change in CIE_x/y vs. Forward Current (3000K, 90CRI)

CIM-9 18V Optical & Electrical Characteristics

Relative Output Flux vs. Forward Current @ 85°C

Forward Current vs. Forward Voltage @ 85°C

Relative Output Flux vs. Junction Temperature

Change in Voltage vs. Junction Temperature

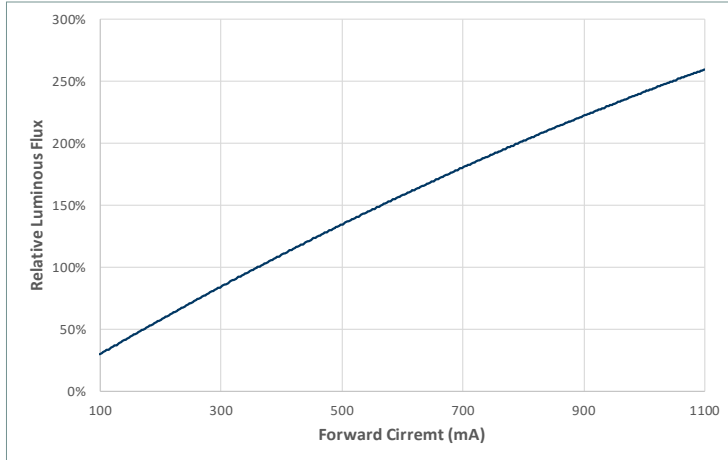
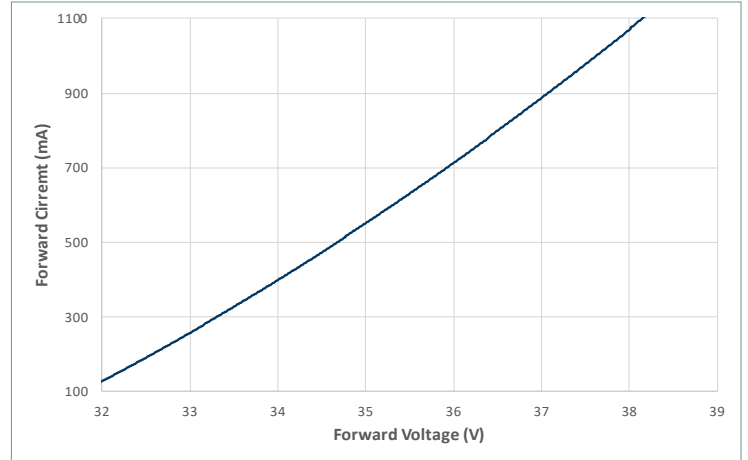
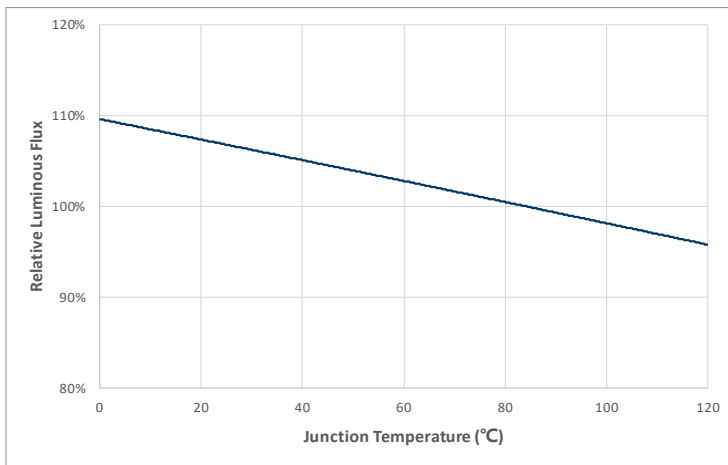
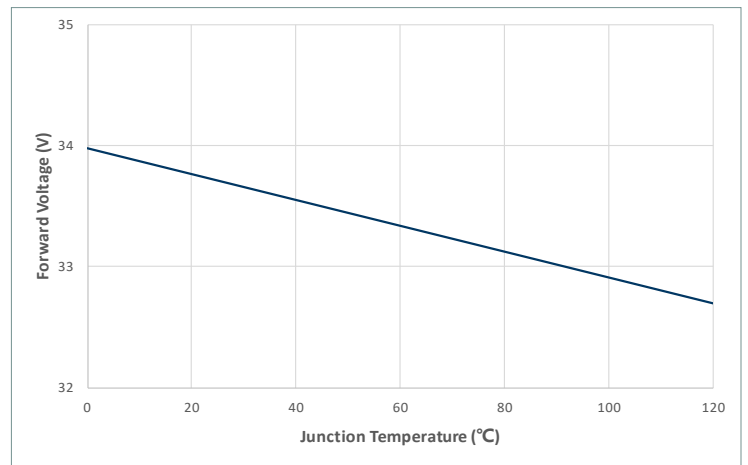
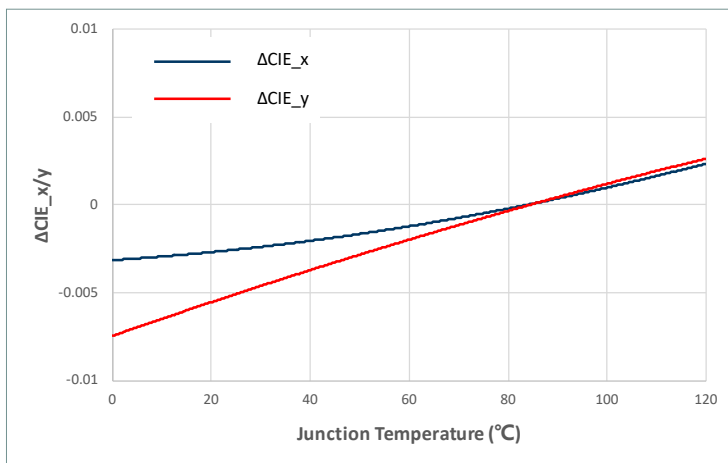
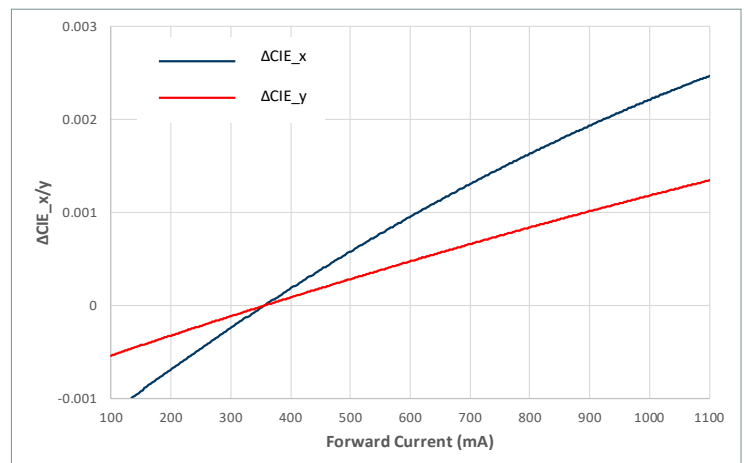
Change in CIE_x/y vs. Junction Temp. (3000K, 90CRI)

Change in CIE_x/y vs. Forward Current (3000K, 90CRI)

CLM-9 Optical & Electrical Characteristics

Relative Output Flux vs. Forward Current @ 85°C

Forward Current vs. Forward Voltage @ 85°C

Relative Output Flux vs. Junction Temperature

Change in Voltage vs. Junction Temperature

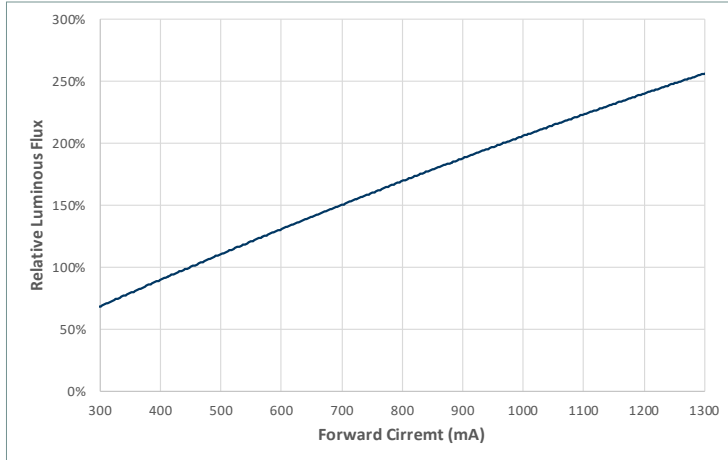
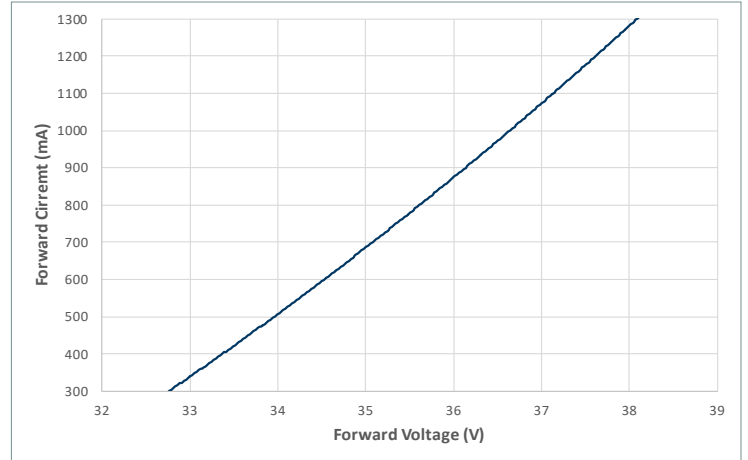
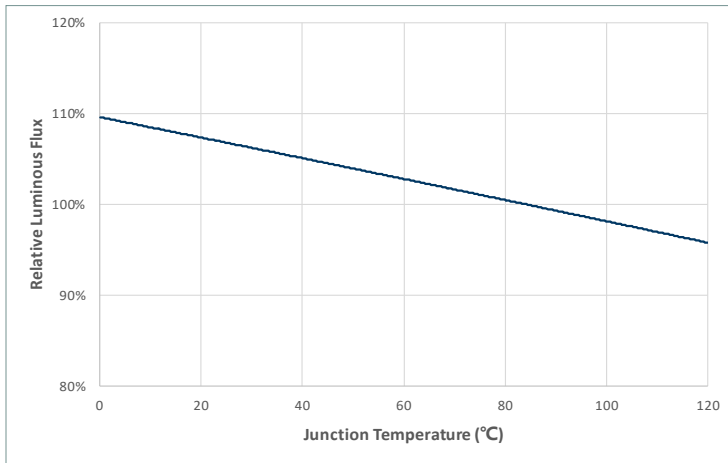
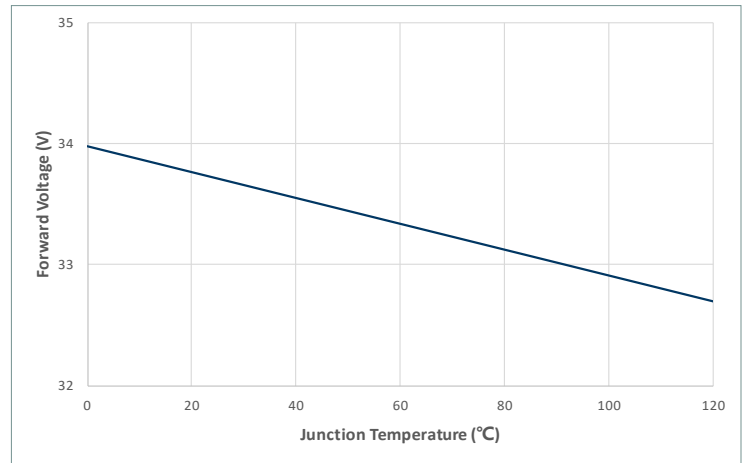
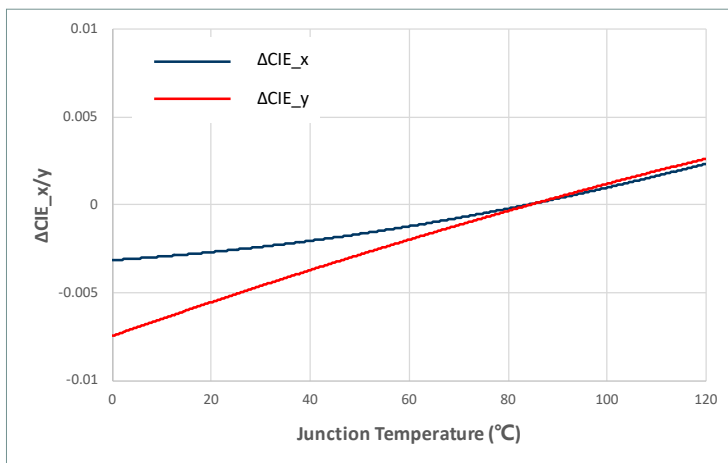
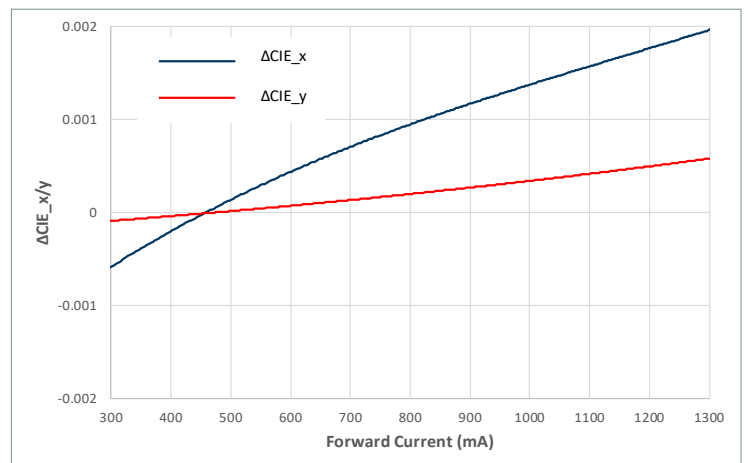
Change in CIE_x/y vs. Junction Temp. (3000K, 90CRI)

Change in CIE_x/y vs. Forward Current (3000K, 90CRI)

CXM-9 Optical & Electrical Characteristics

Relative Output Flux vs. Forward Current @ 85°C

Forward Current vs. Forward Voltage @ 85°C

Relative Output Flux vs. Junction Temperature

Change in Voltage vs. Junction Temperature

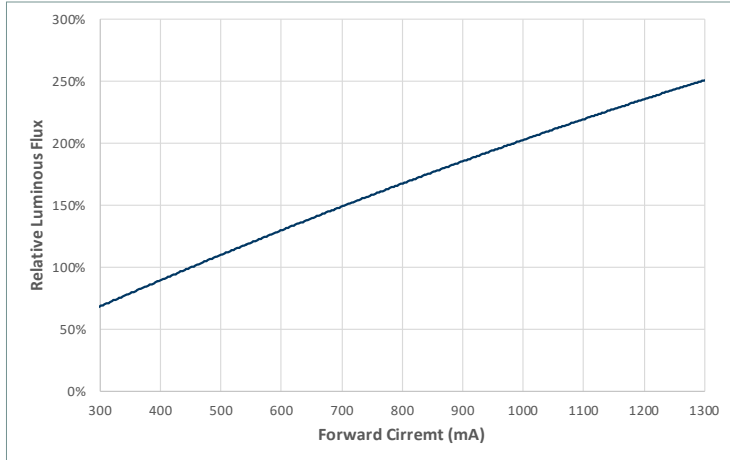
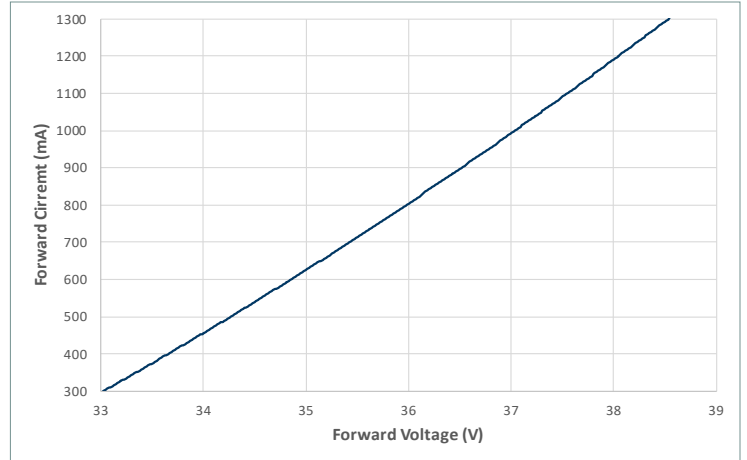
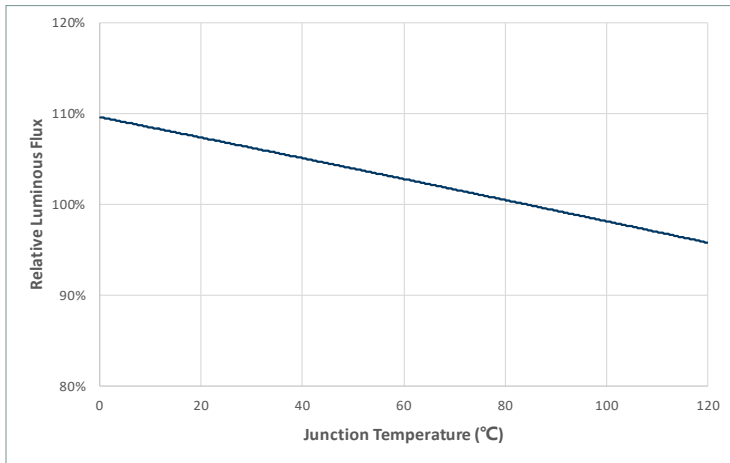
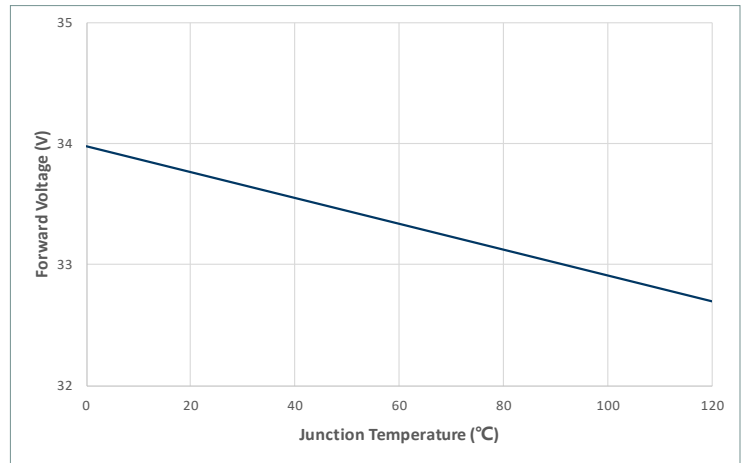
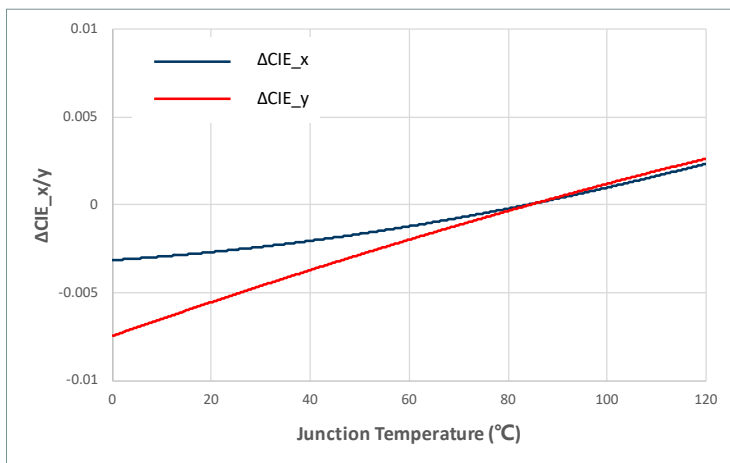
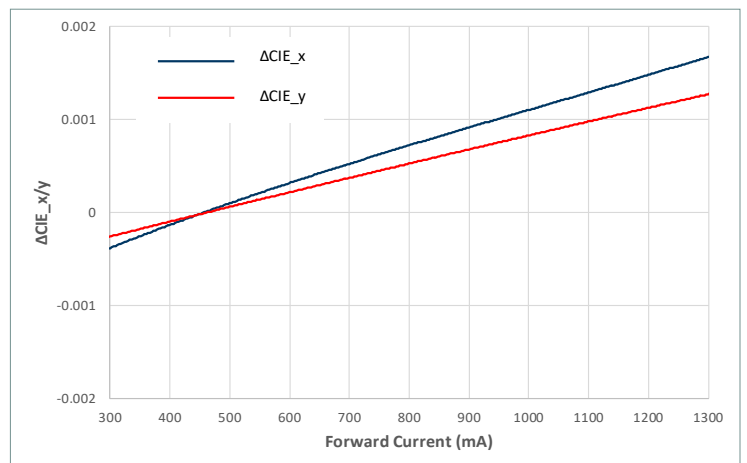
Change in CIE_x/y vs. Junction Temp. (3000K, 90CRI)

Change in CIE_x/y vs. Forward Current (3000K, 90CRI)

CXM-11 Optical & Electrical Characteristics

Relative Output Flux vs. Forward Current @ 85°C

Forward Current vs. Forward Voltage @ 85°C

Relative Output Flux vs. Junction Temperature

Change in Voltage vs. Junction Temperature

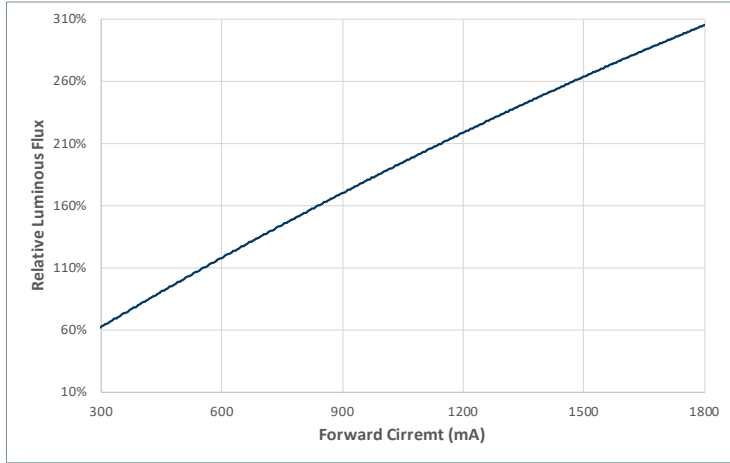
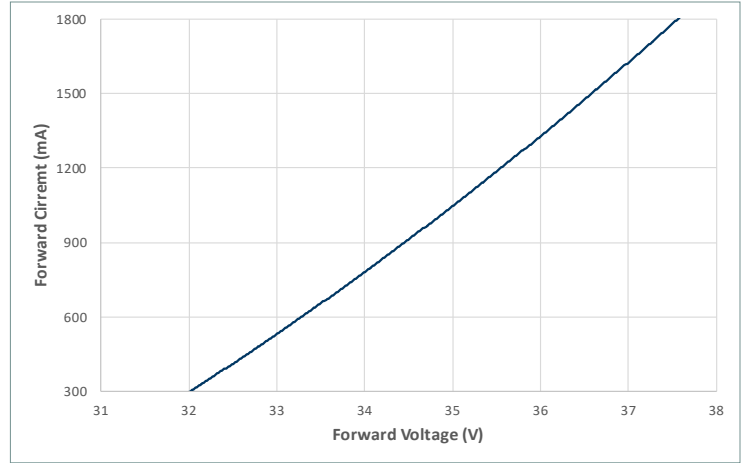
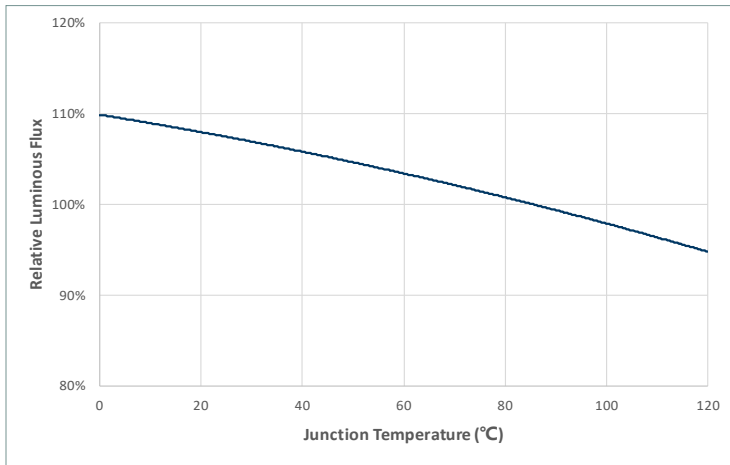
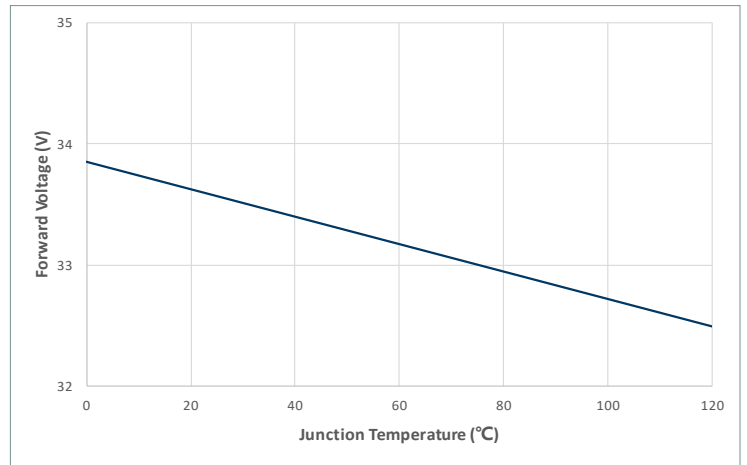
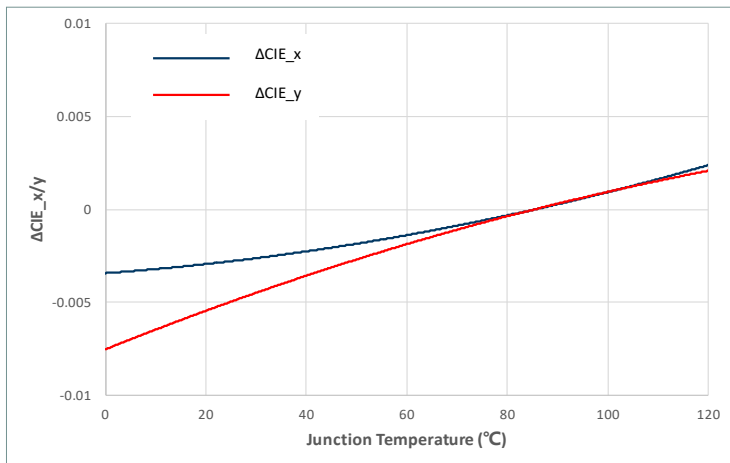
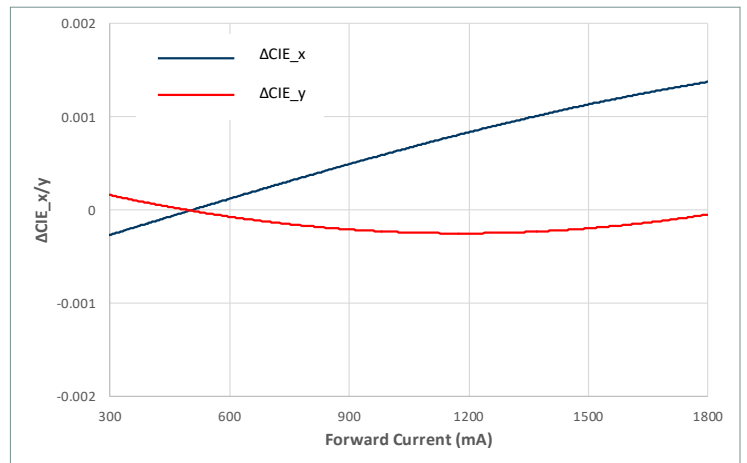
Change in CIE_x/y vs. Junction Temp. (3000K, 90CRI)

Change in CIE_x/y vs. Forward Current (3000K, 90CRI)

CIM-14 Optical & Electrical Characteristics

Relative Output Flux vs. Forward Current @ 85°C

Forward Current vs. Forward Voltage @ 85°C

Relative Output Flux vs. Junction Temperature

Change in Voltage vs. Junction Temperature

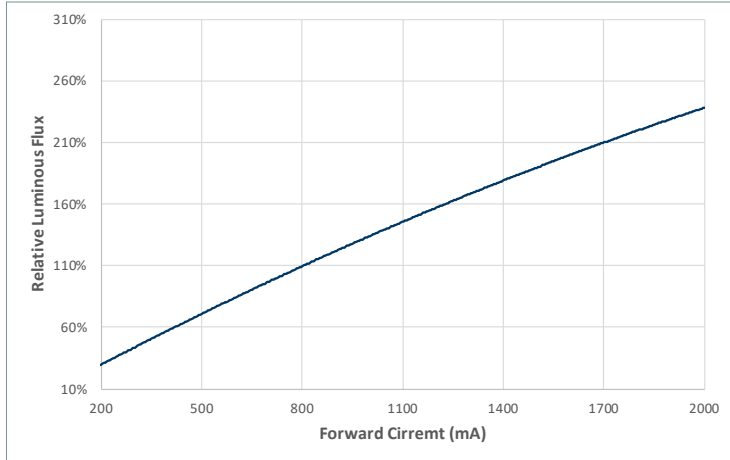
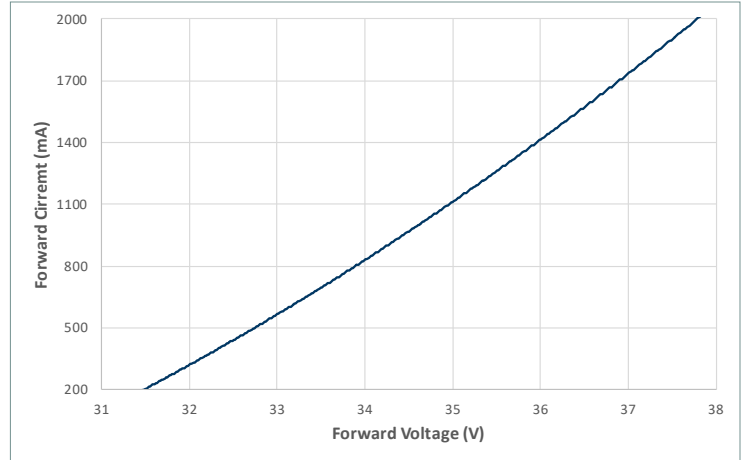
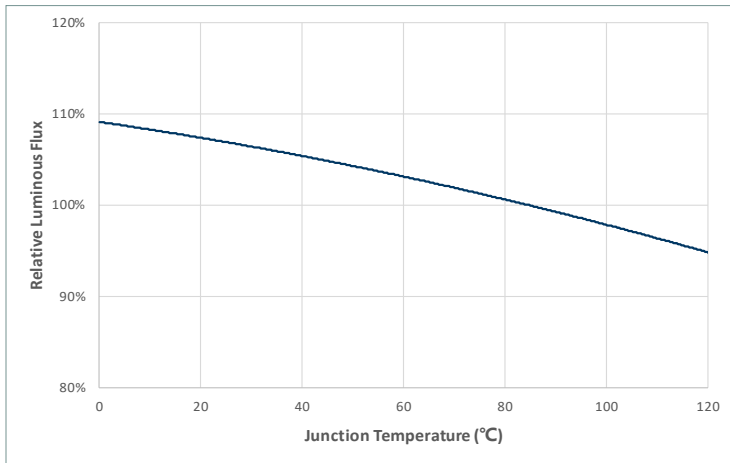
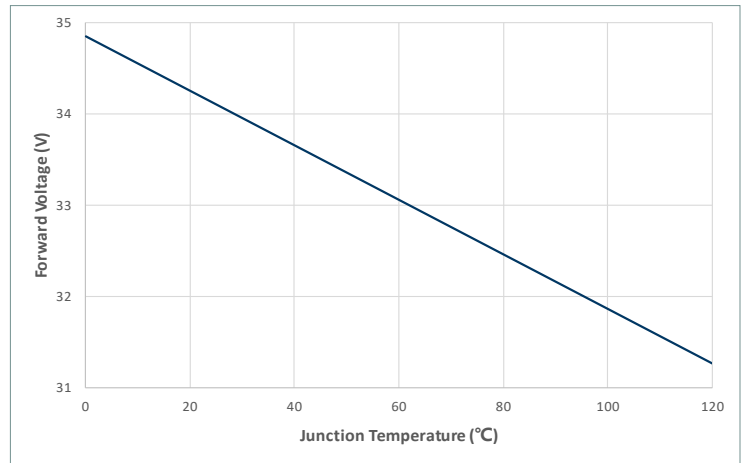
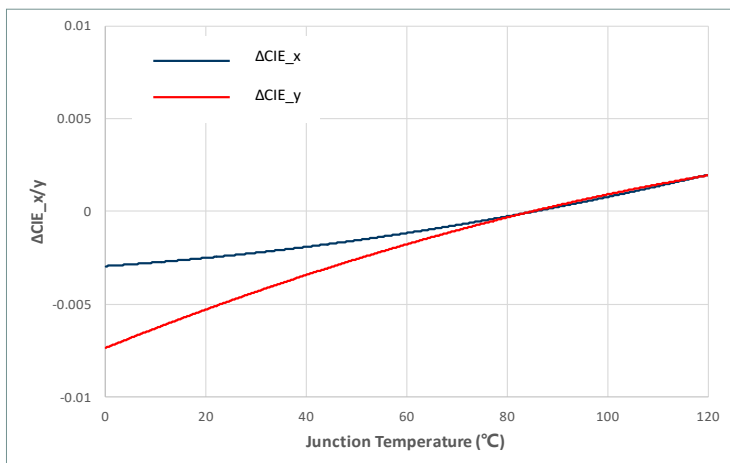
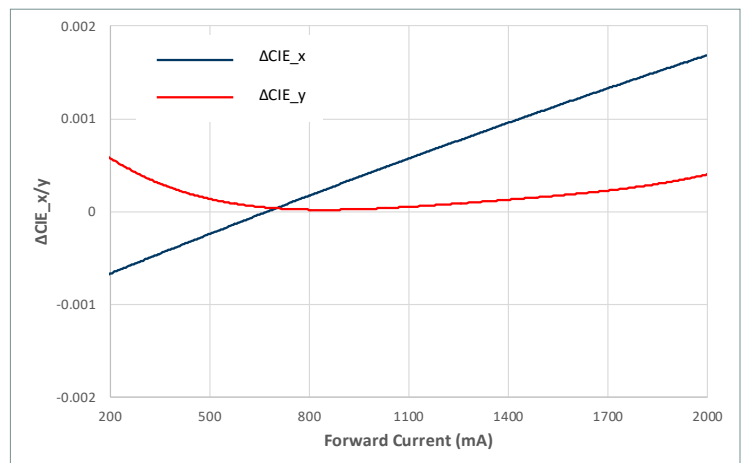
Change in CIE_x/y vs. Junction Temp. (3000K, 90CRI)

Change in CIE_x/y vs. Forward Current (3000K, 90CRI)

CLM-14 Optical & Electrical Characteristics

Relative Output Flux vs. Forward Current @ 85°C

Forward Current vs. Forward Voltage @ 85°C

Relative Output Flux vs. Junction Temperature

Change in Voltage vs. Junction Temperature

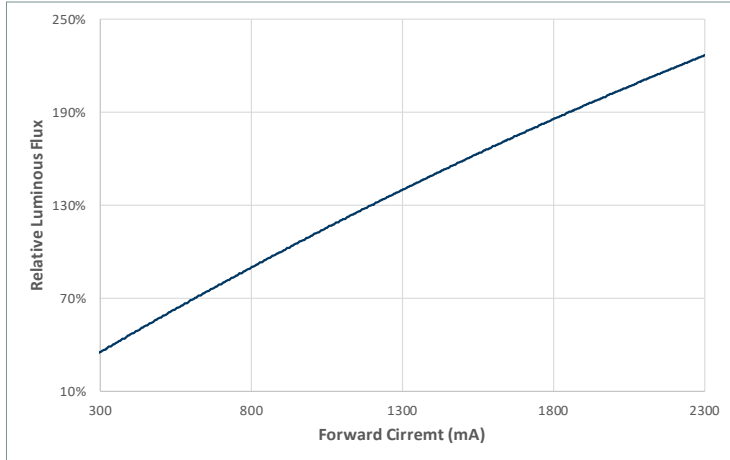
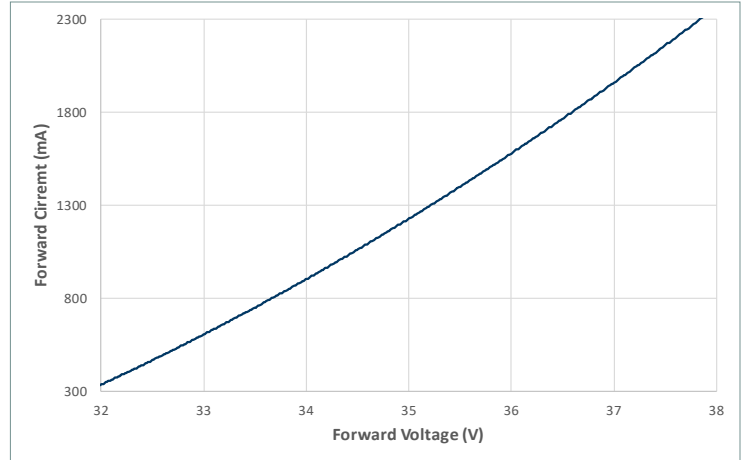
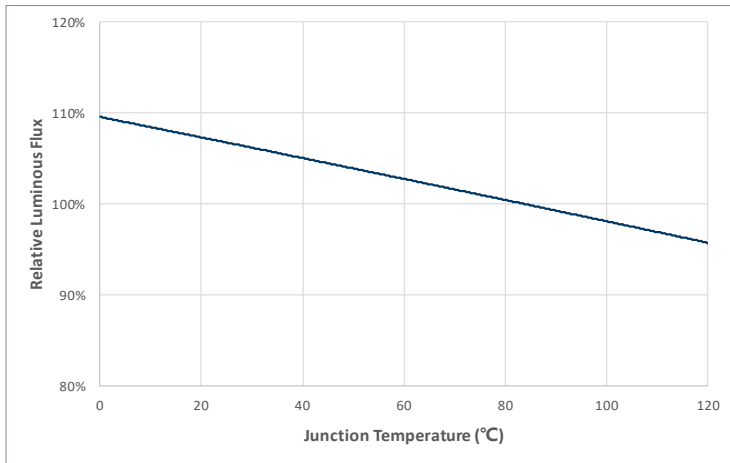
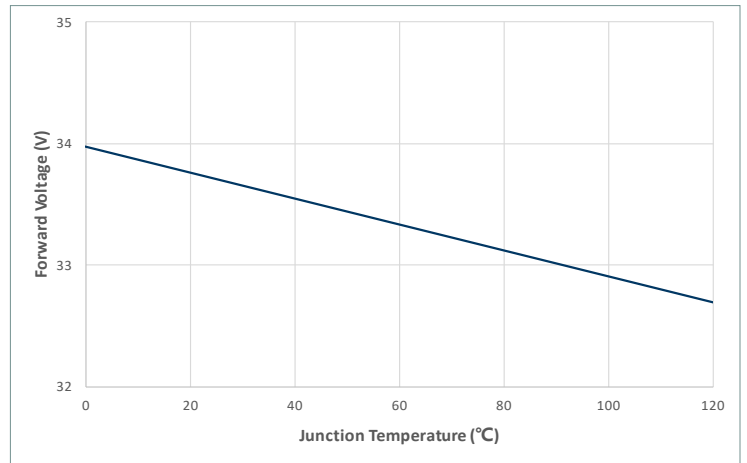
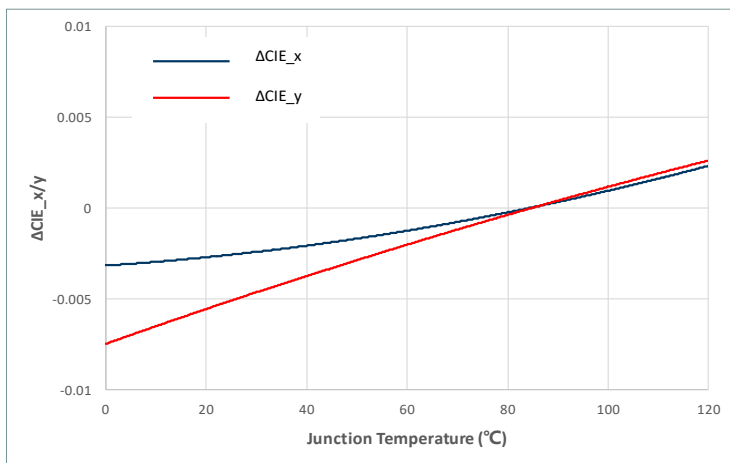
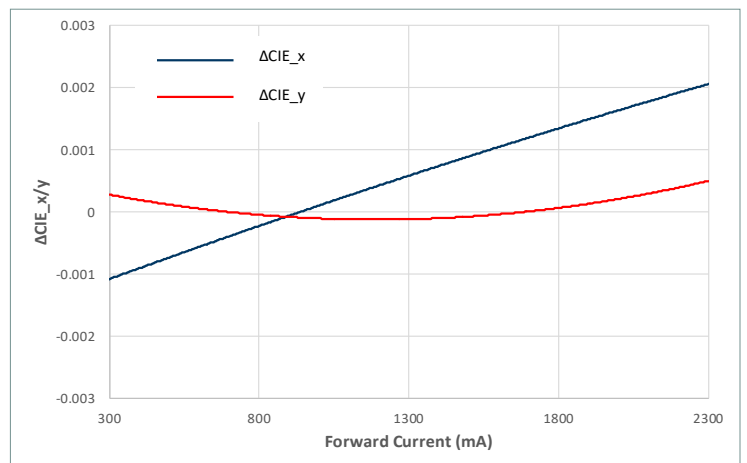
Change in CIE_x/y vs. Junction Temp. (3000K, 90CRI)

Change in CIE_x/y vs. Forward Current (3000K, 90CRI)

CXM-14 Optical & Electrical Characteristics

Relative Output Flux vs. Forward Current @ 85°C

Forward Current vs. Forward Voltage @ 85°C

Relative Output Flux vs. Junction Temperature

Change in Voltage vs. Junction Temperature

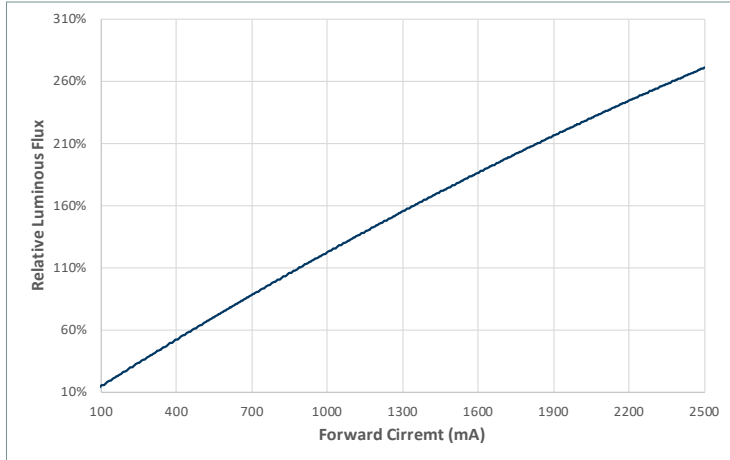
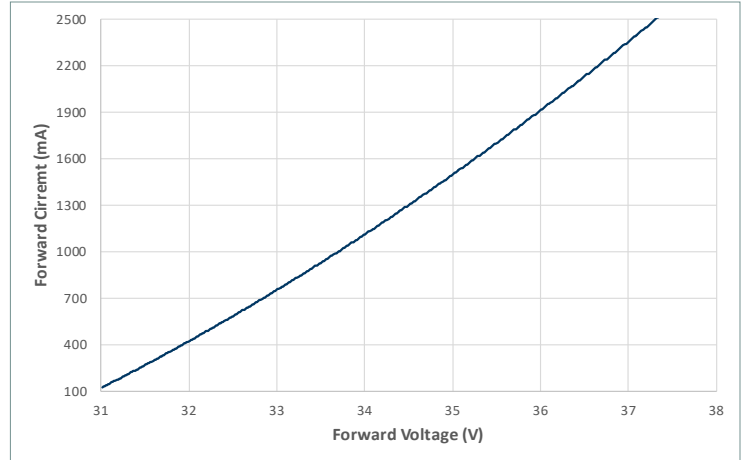
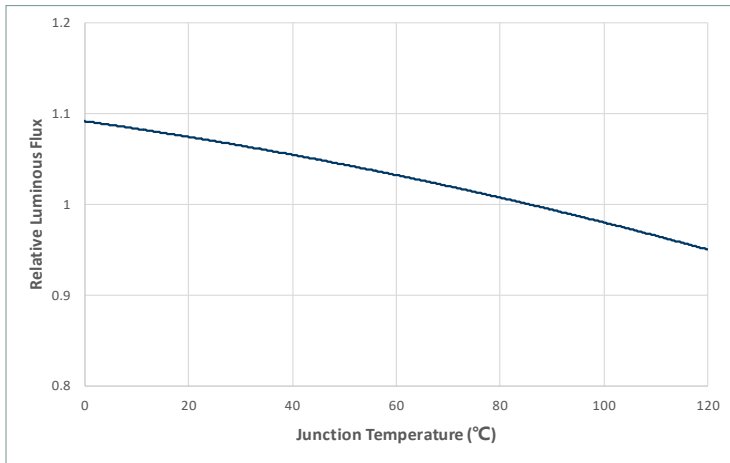
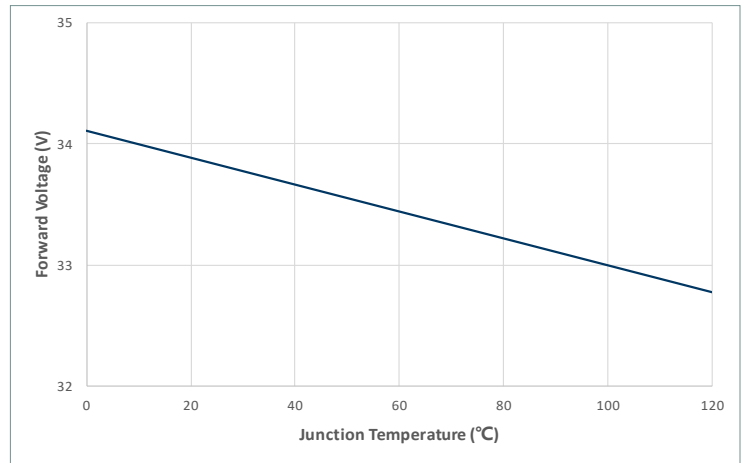
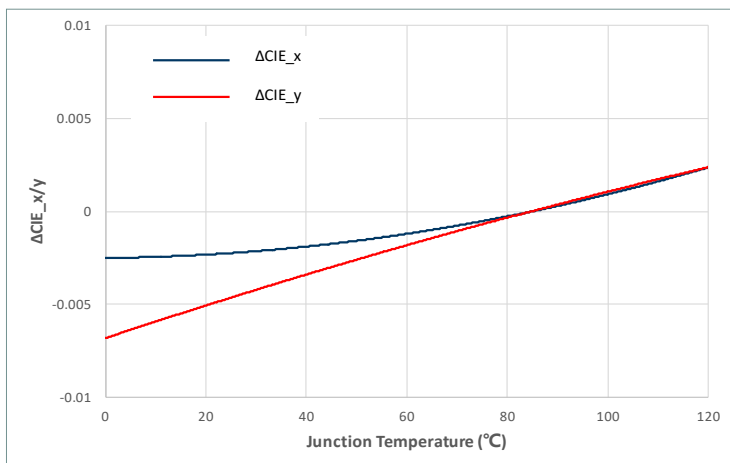
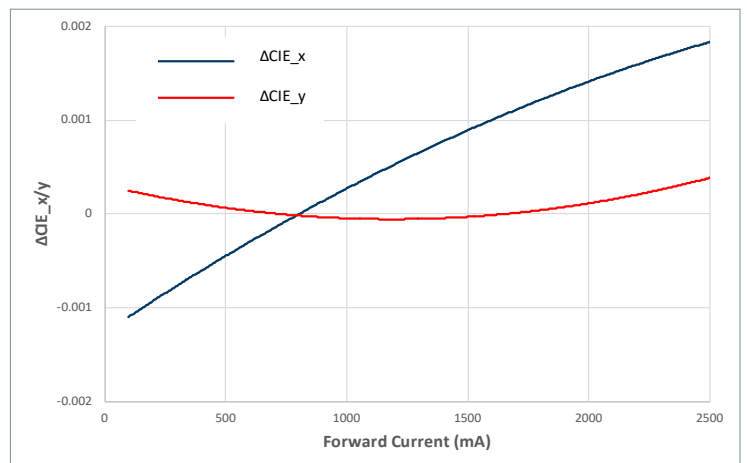
Change in CIE_x/y vs. Junction Temp. (3000K, 90CRI)

Change in CIE_x/y vs. Forward Current (3000K, 90CRI)

CGM-14 Optical & Electrical Characteristics

Relative Output Flux vs. Forward Current @ 85°C

Forward Current vs. Forward Voltage @ 85°C

Relative Output Flux vs. Junction Temperature

Change in Voltage vs. Junction Temperature

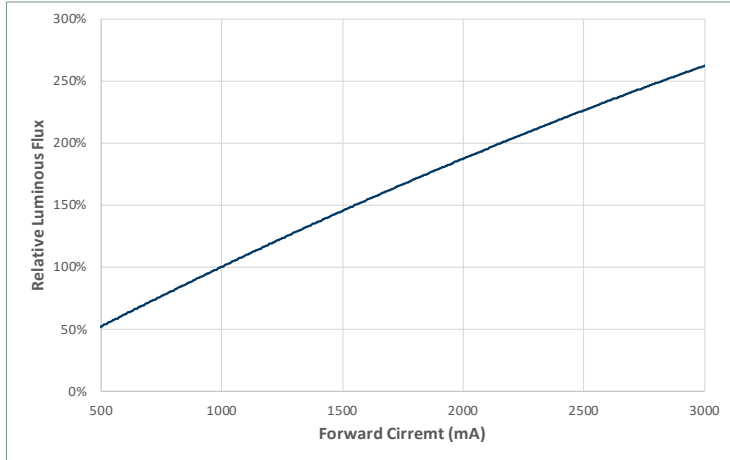
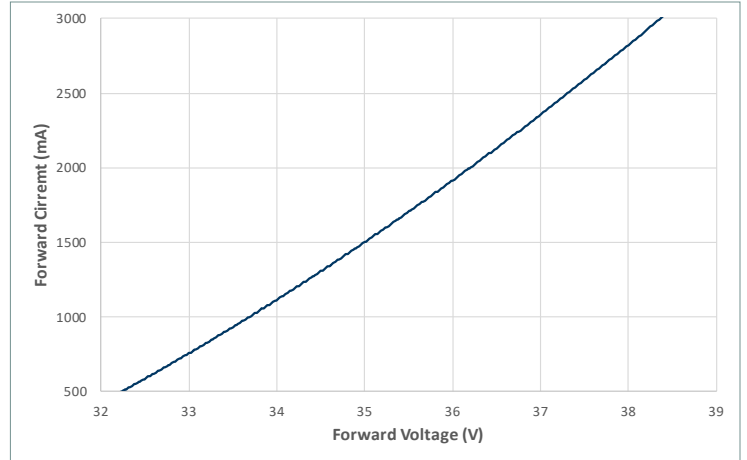
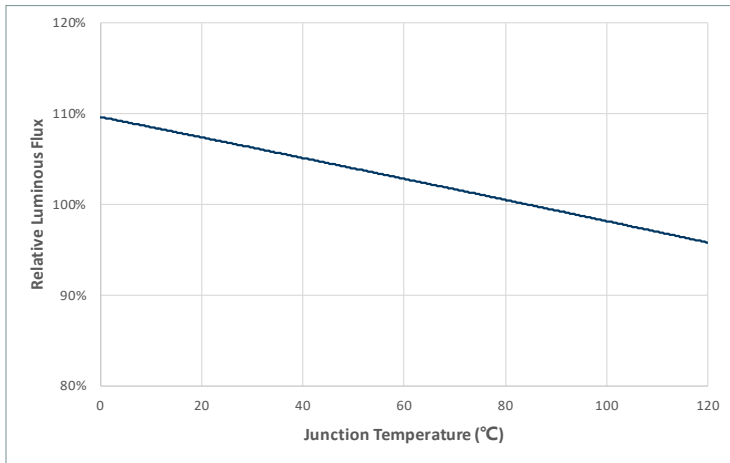
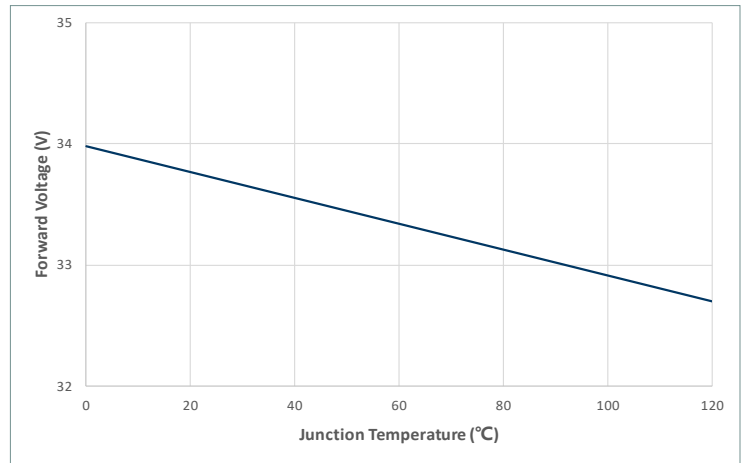
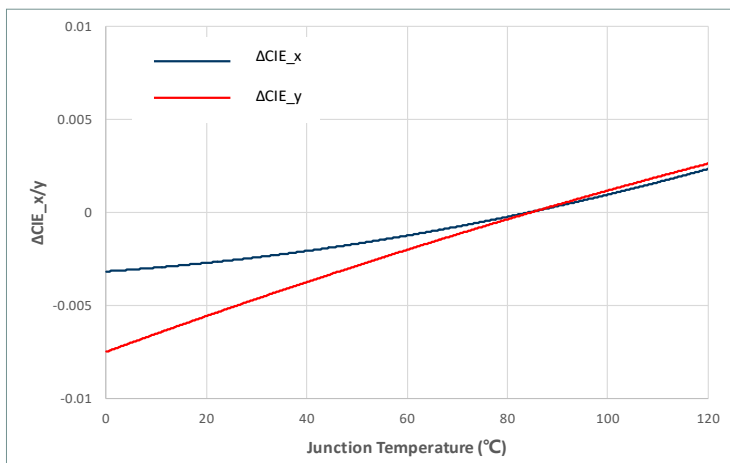
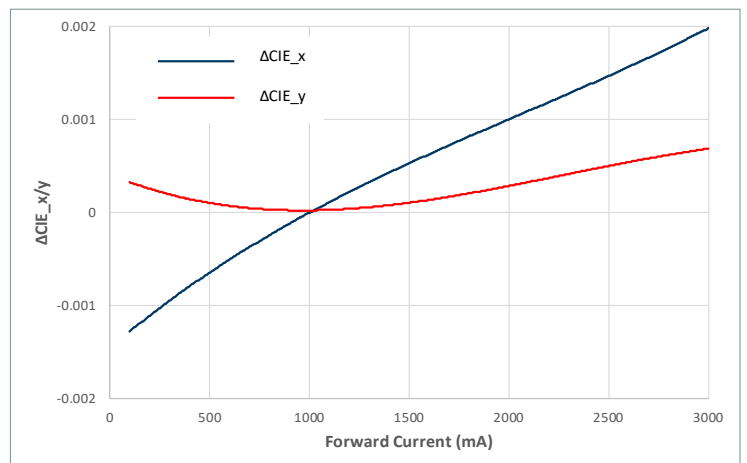
Change in CIE_x/y vs. Junction Temp. (3000K, 90CRI)

Change in CIE_x/y vs. Forward Current (3000K, 90CRI)

CXM-18 Optical & Electrical Characteristics

Relative Output Flux vs. Forward Current @ 85°C

Forward Current vs. Forward Voltage @ 85°C

Relative Output Flux vs. Junction Temperature

Change in Voltage vs. Junction Temperature

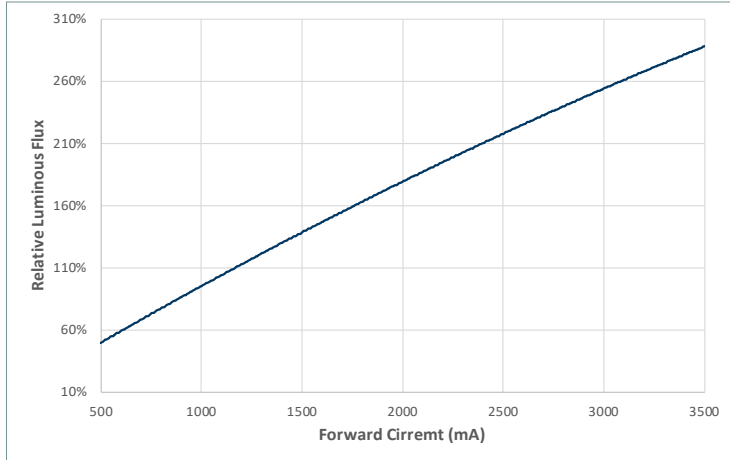
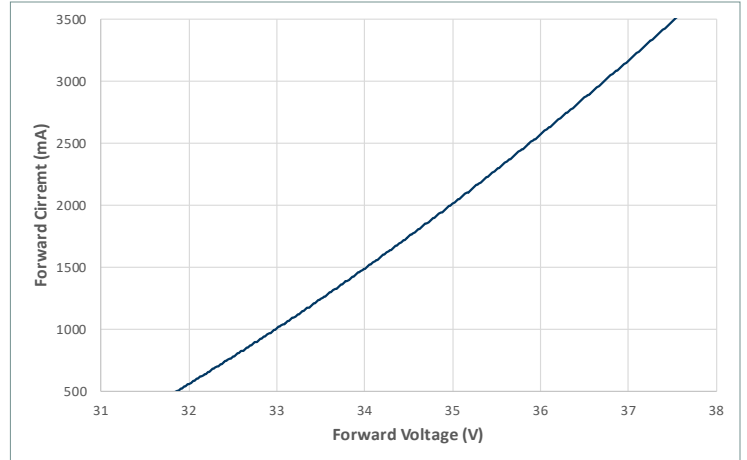
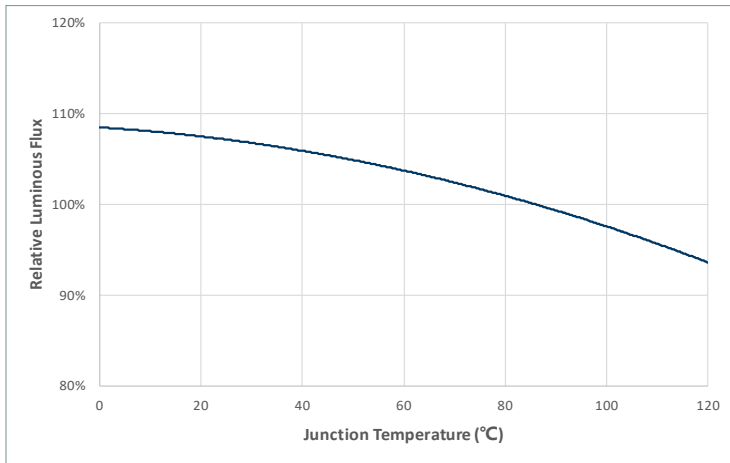
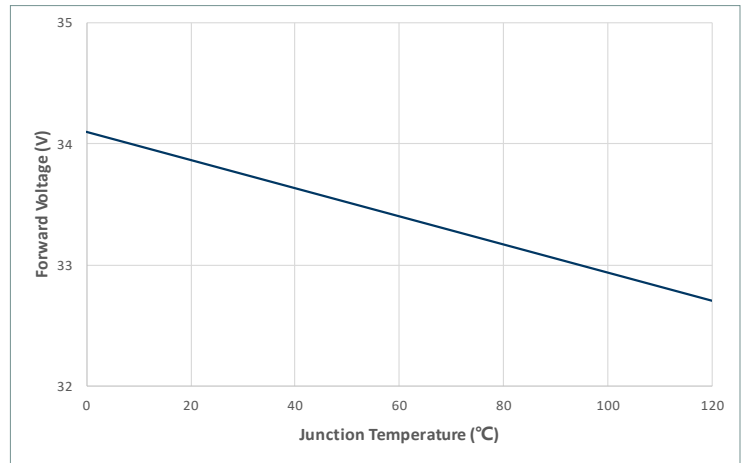
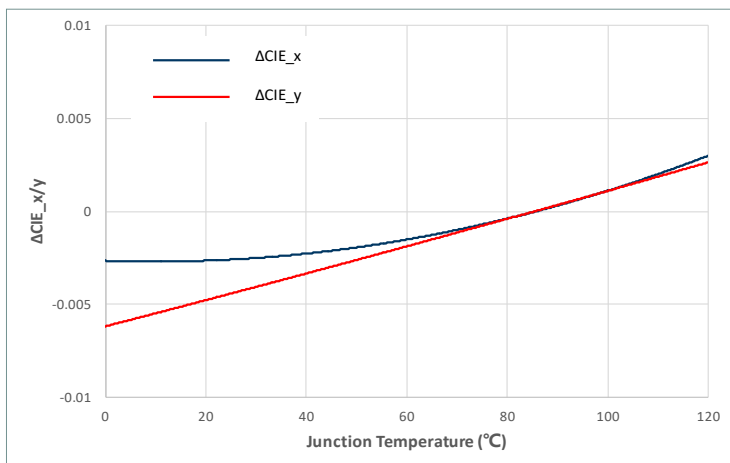
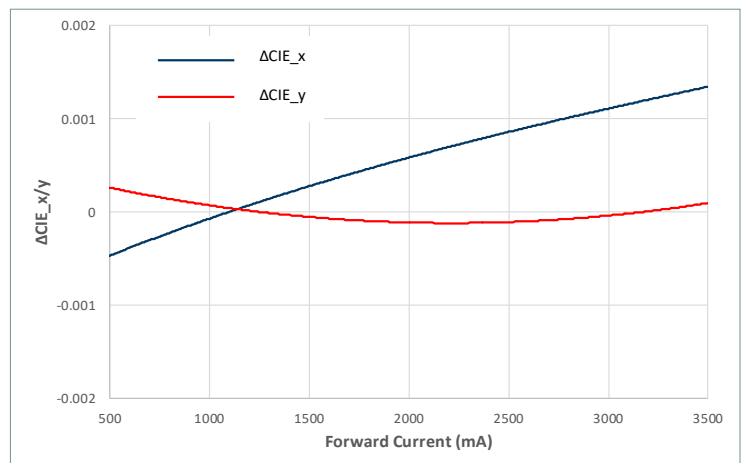
Change in CIE_x/y vs. Junction Temp. (3000K, 90CRI)

Change in CIE_x/y vs. Forward Current (3000K, 90CRI)

CIM-22 Optical & Electrical Characteristics

Relative Output Flux vs. Forward Current @ 85°C

Forward Current vs. Forward Voltage @ 85°C

Relative Output Flux vs. Junction Temperature

Change in Voltage vs. Junction Temperature

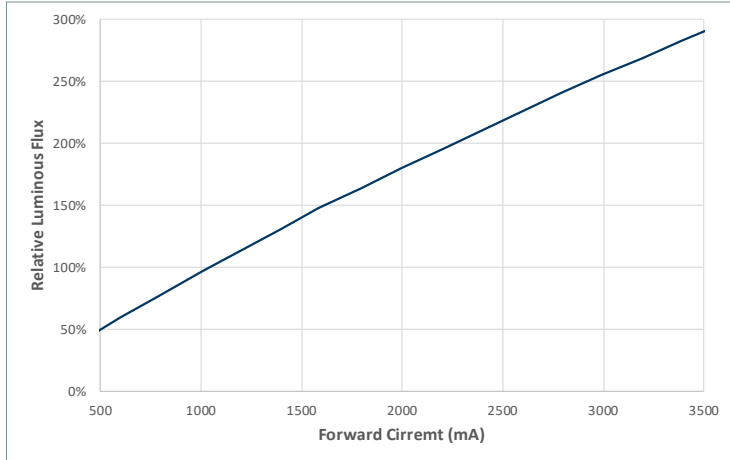
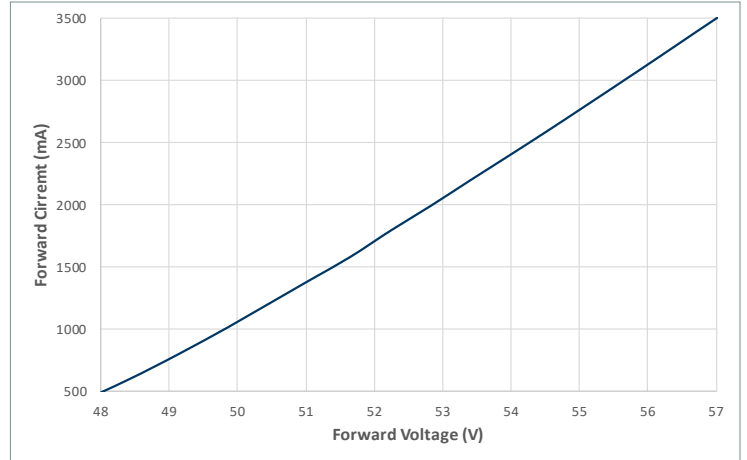
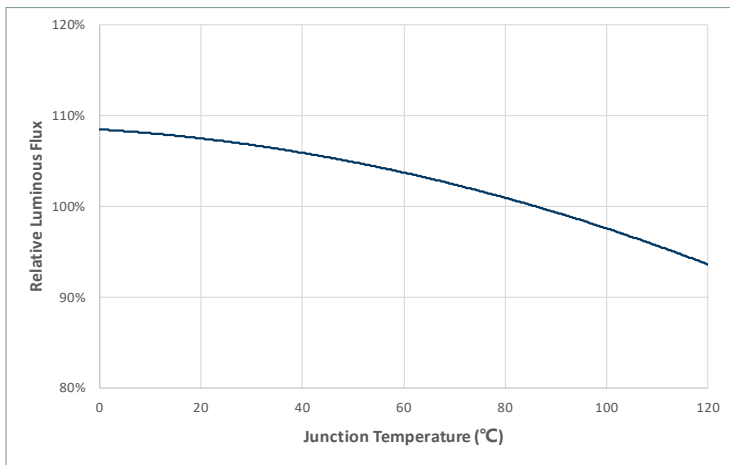
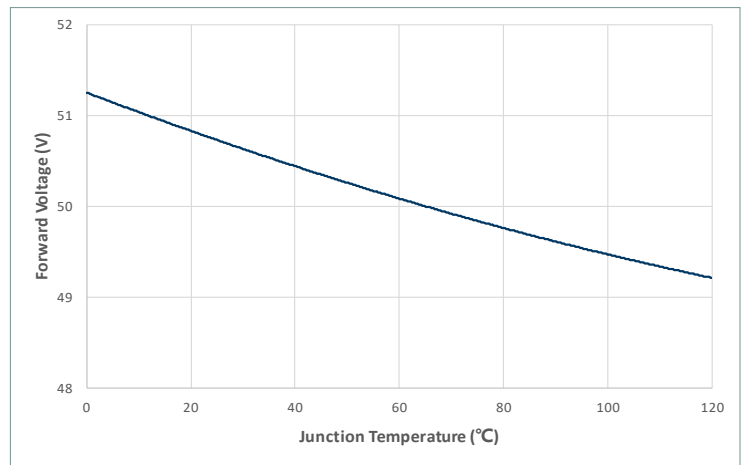
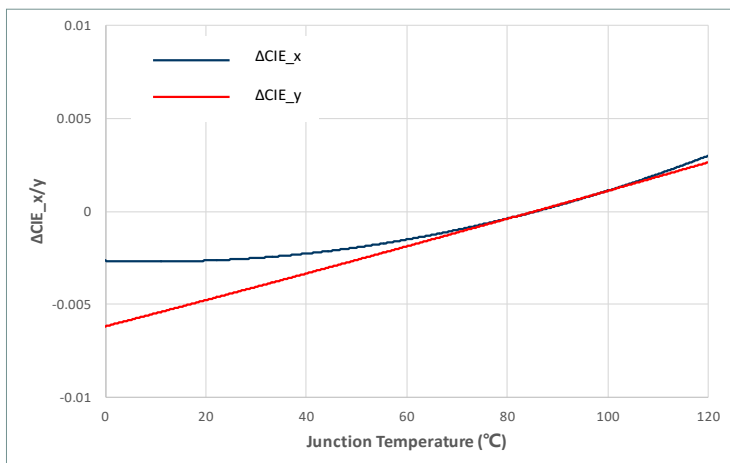
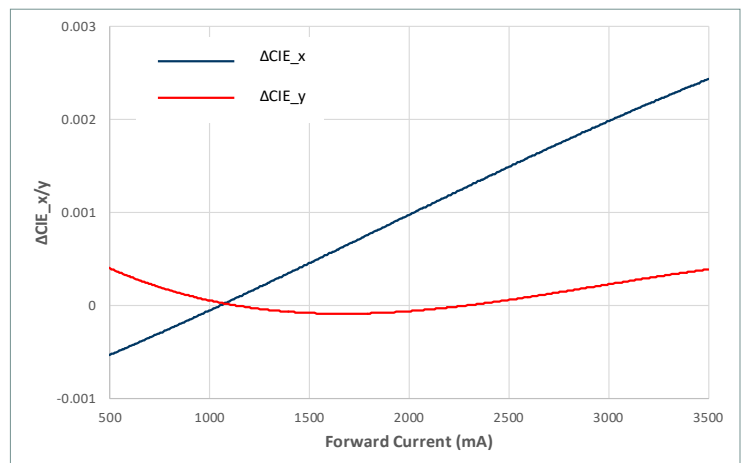
Change in CIE_x/y vs. Junction Temp. (3000K, 90CRI)

Change in CIE_x/y vs. Forward Current (3000K, 90CRI)

CLM-22 Optical & Electrical Characteristics

Relative Output Flux vs. Forward Current @ 85°C

Forward Current vs. Forward Voltage @ 85°C

Relative Output Flux vs. Junction Temperature

Change in Voltage vs. Junction Temperature

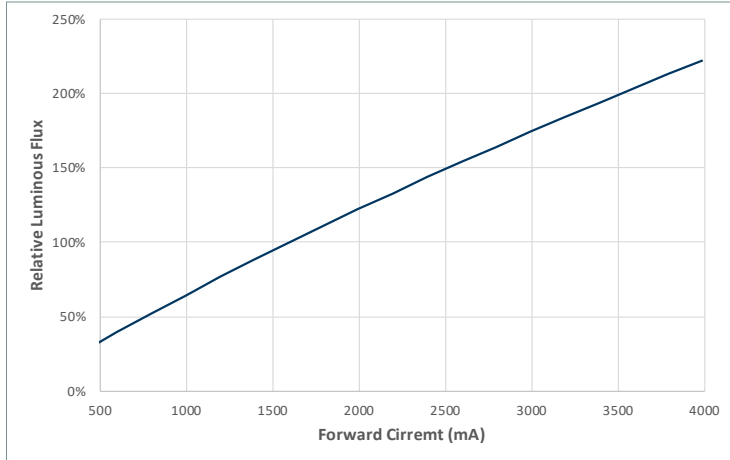
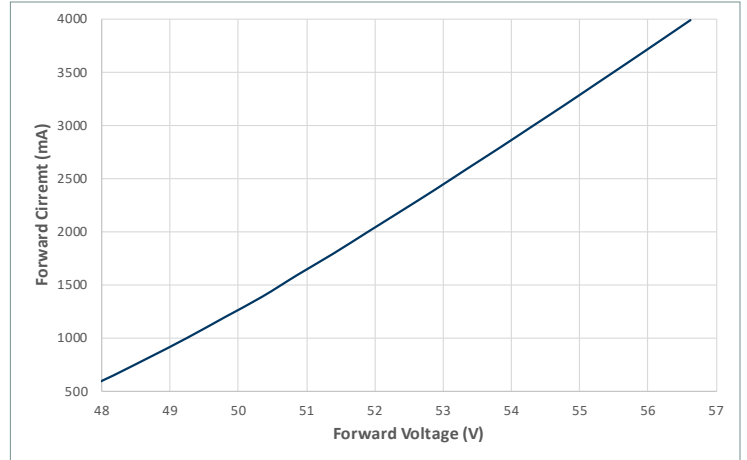
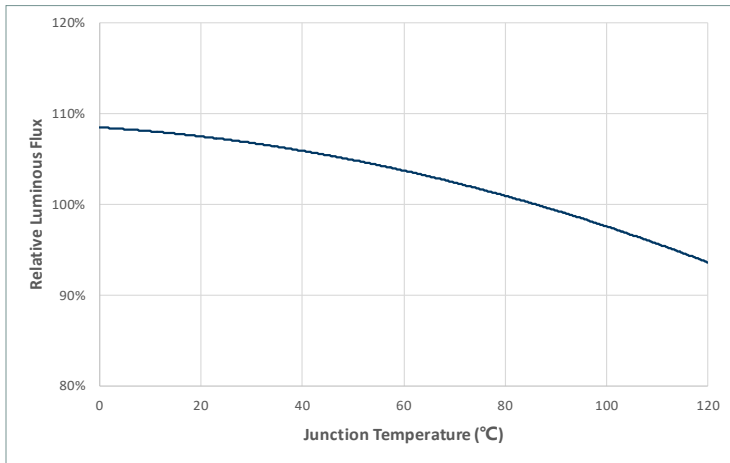
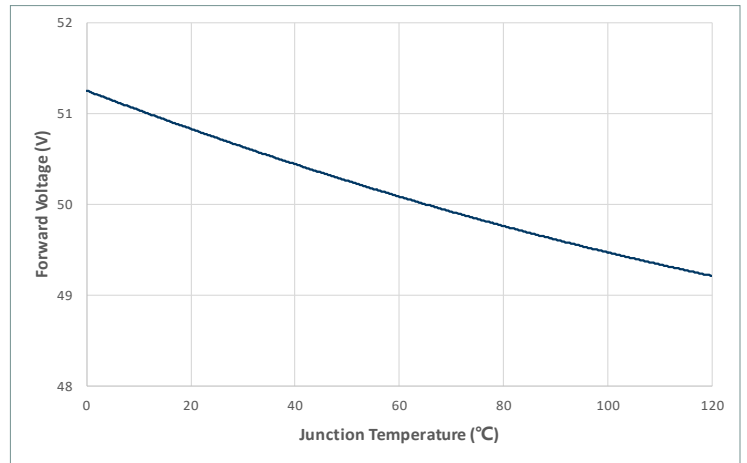
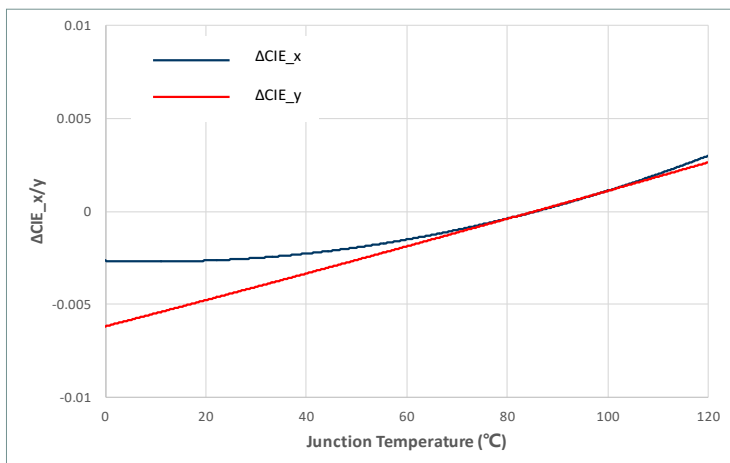
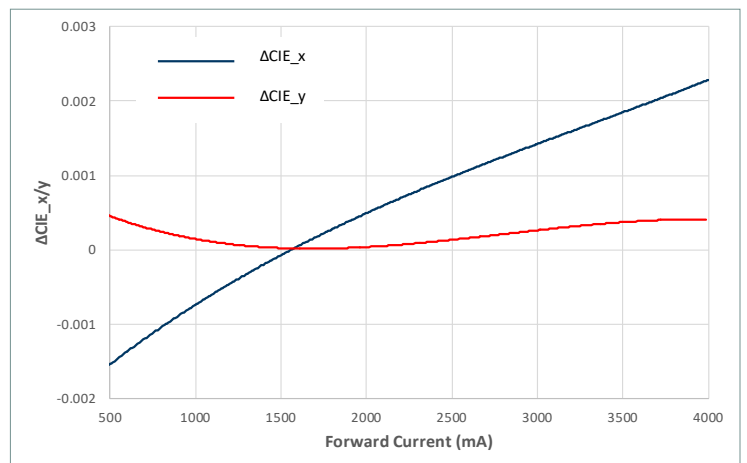
Change in CIE_x/y vs. Junction Temp. (3000K, 90CRI)

Change in CIE_x/y vs. Forward Current (3000K, 90CRI)

CXM-22 Optical & Electrical Characteristics

Relative Output Flux vs. Forward Current @ 85°C

Forward Current vs. Forward Voltage @ 85°C

Relative Output Flux vs. Junction Temperature

Change in Voltage vs. Junction Temperature

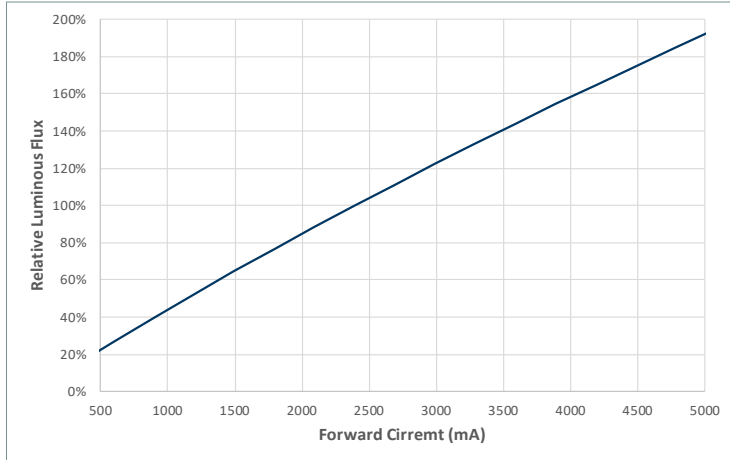
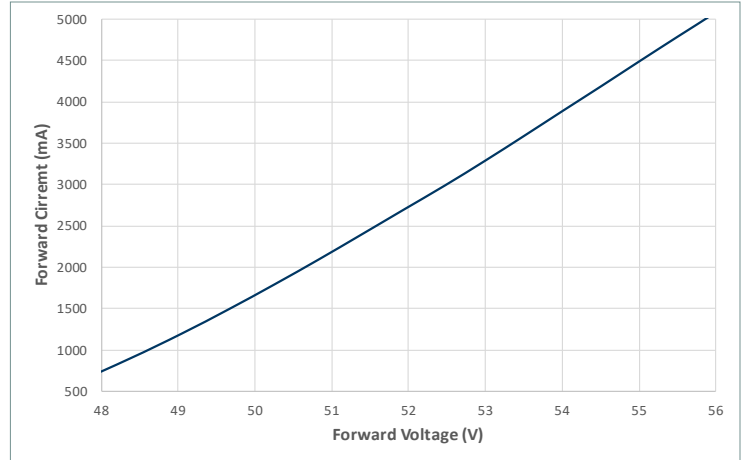
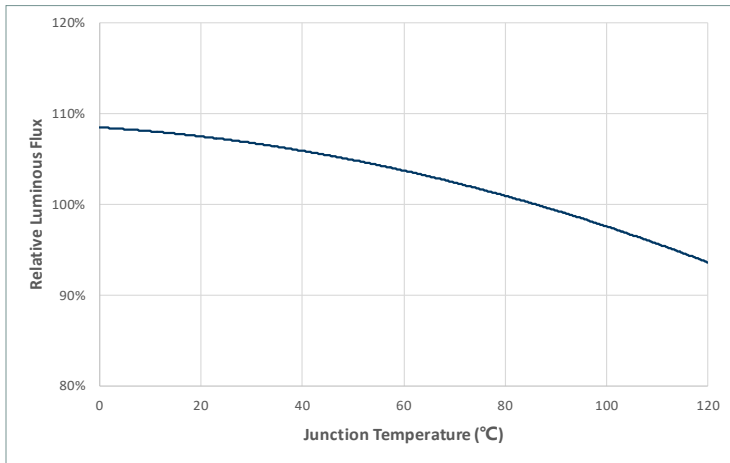
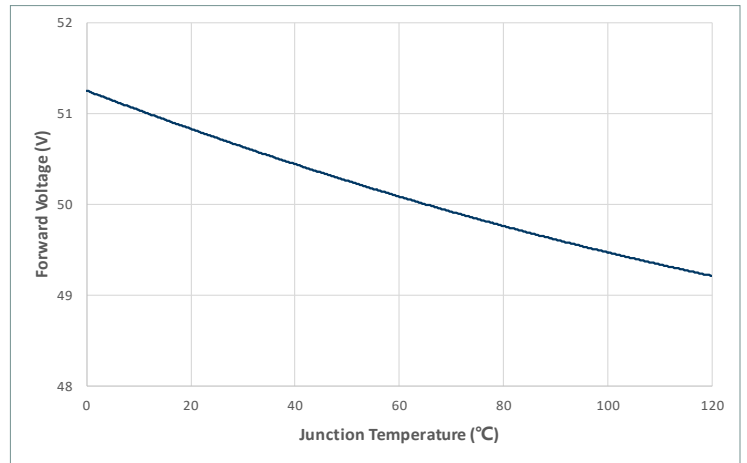
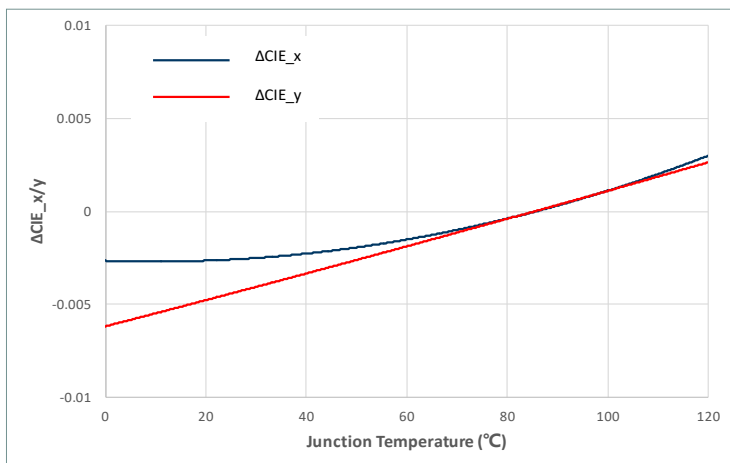
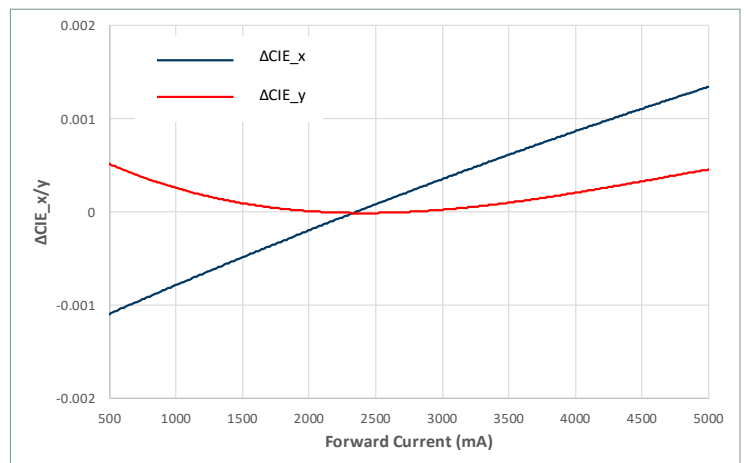
Change in CIE_x/y vs. Junction Temp. (3000K, 90CRI)

Change in CIE_x/y vs. Forward Current (3000K, 90CRI)

CGM-22 Optical & Electrical Characteristics

Relative Output Flux vs. Forward Current @ 85°C

Forward Current vs. Forward Voltage @ 85°C

Relative Output Flux vs. Junction Temperature

Change in Voltage vs. Junction Temperature

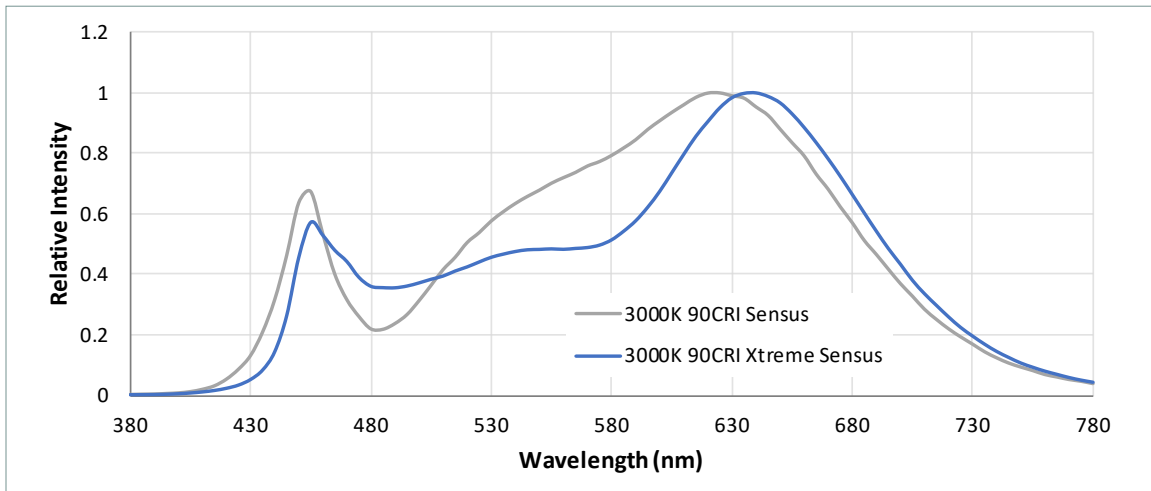
Change in CIE_x/y vs. Junction Temp. (3000K, 90CRI)

Change in CIE_x/y vs. Forward Current (3000K, 90CRI)

CXM-32 Optical & Electrical Characteristics

Relative Output Flux vs. Forward Current @ 85°C

Forward Current vs. Forward Voltage @ 85°C

Relative Output Flux vs. Junction Temperature

Change in Voltage vs. Junction Temperature

Change in CIE_x/y vs. Junction Temp. (3000K, 90CRI)

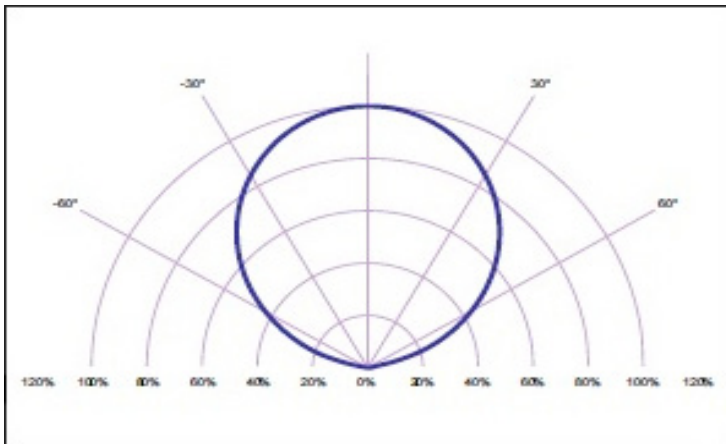
Change in CIE_x/y vs. Forward Current (3000K, 90CRI)

Typical Spectrum



Radiation Pattern

Typical Polar Radiation Pattern



Typical Angular Radiation Pattern

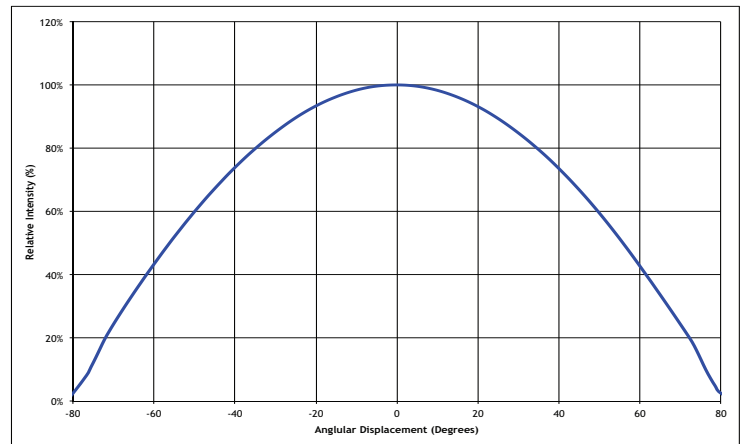

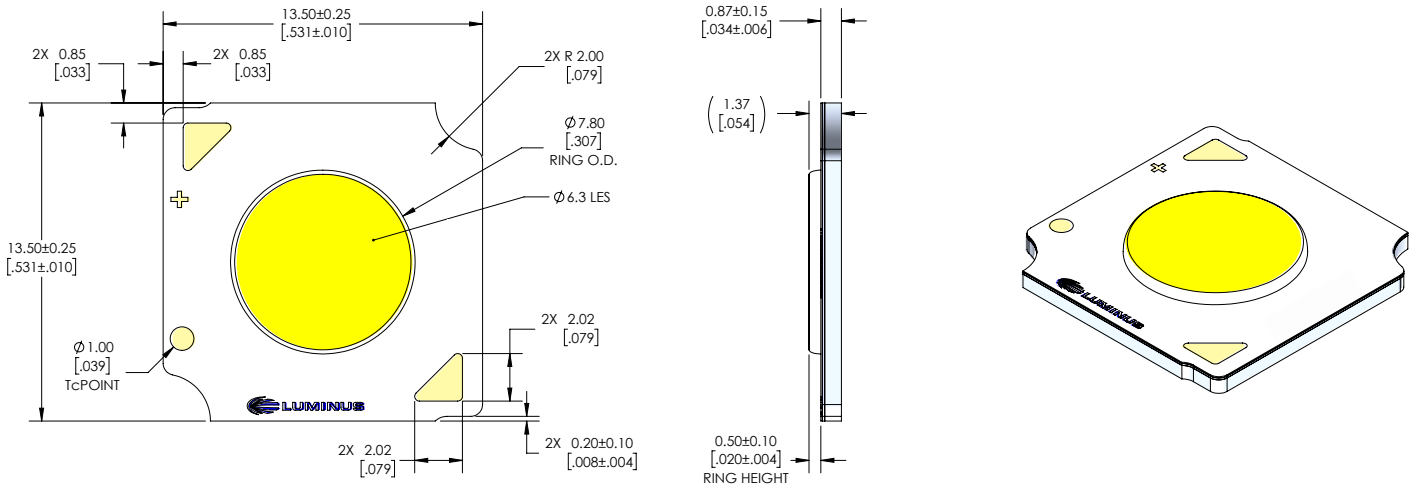
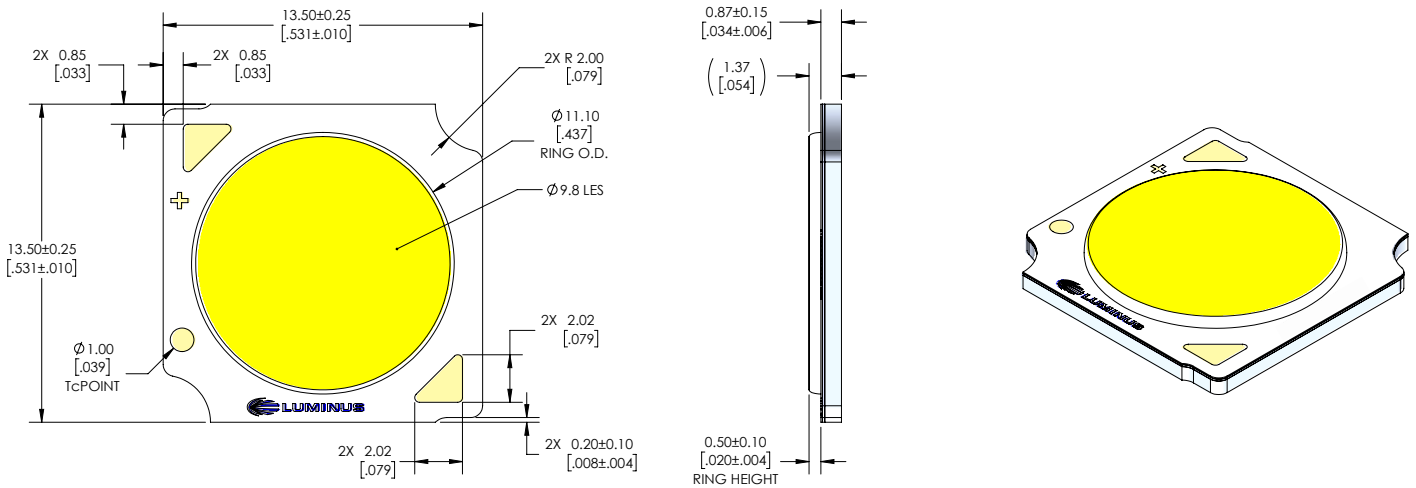
CXM-6 Mechanical Dimensions

CIM-9/CLM-9/CXM-9 AC Substrate Mechanical Dimensions

CXM-6/CIM-9/CLM-9/CXM-9 AC Series Shipping Container

Note: 80 pcs per tray and 5 trays are stacked together to be sealed in an anti-static bag.

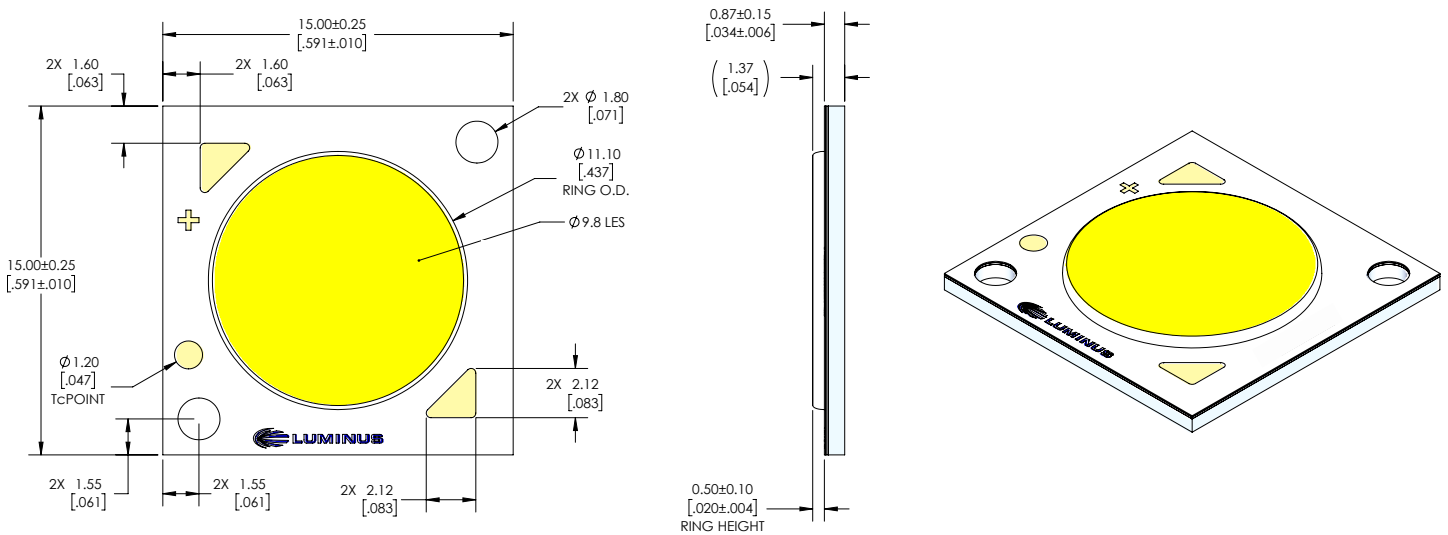

Note: The anti-static bag is boxed for easier storage, 400 pcs per box.

CXM-9 AA Substrate Mechanical Dimensions



CXM-9 AA Series Shipping Container



Note: 60 pcs per tray and 5 trays are stacked together to be sealed in an anti-static bag.



Note: The anti-static bag is boxed for easier storage, 300pcs per box.

CXM-11 AA Substrate Mechanical Dimensions

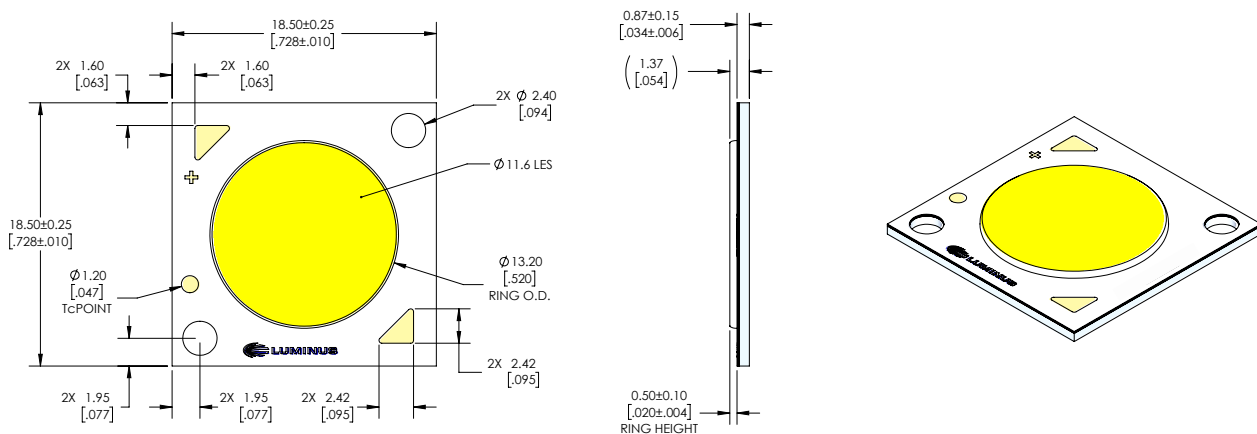

CXM-14 AA Substrate Mechanical Dimensions

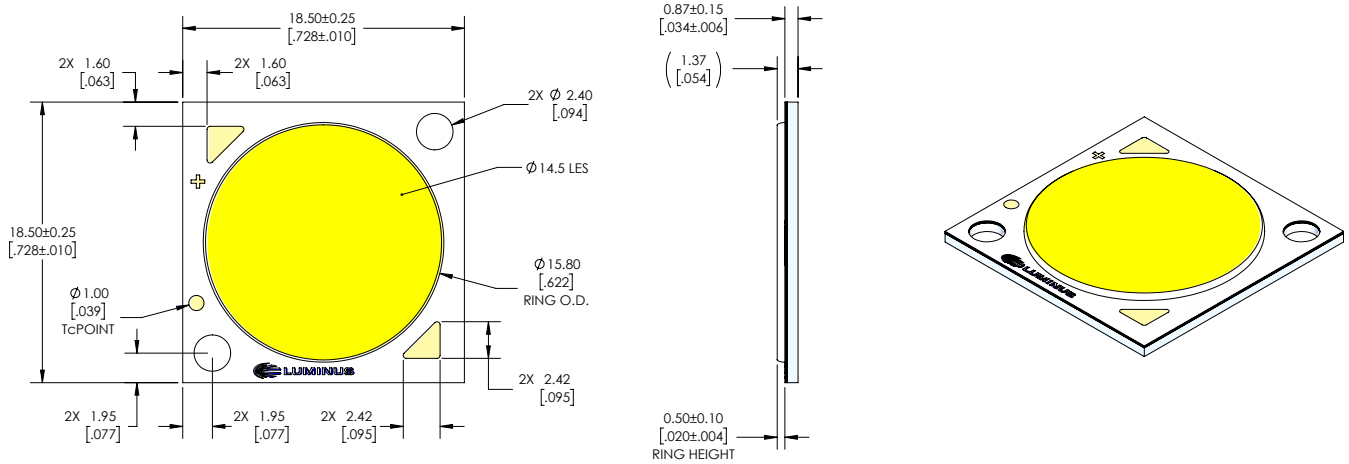

CIM-14/CLM-14/CXM-14/CGM-14 AC Substrate Mechanical Dimensions

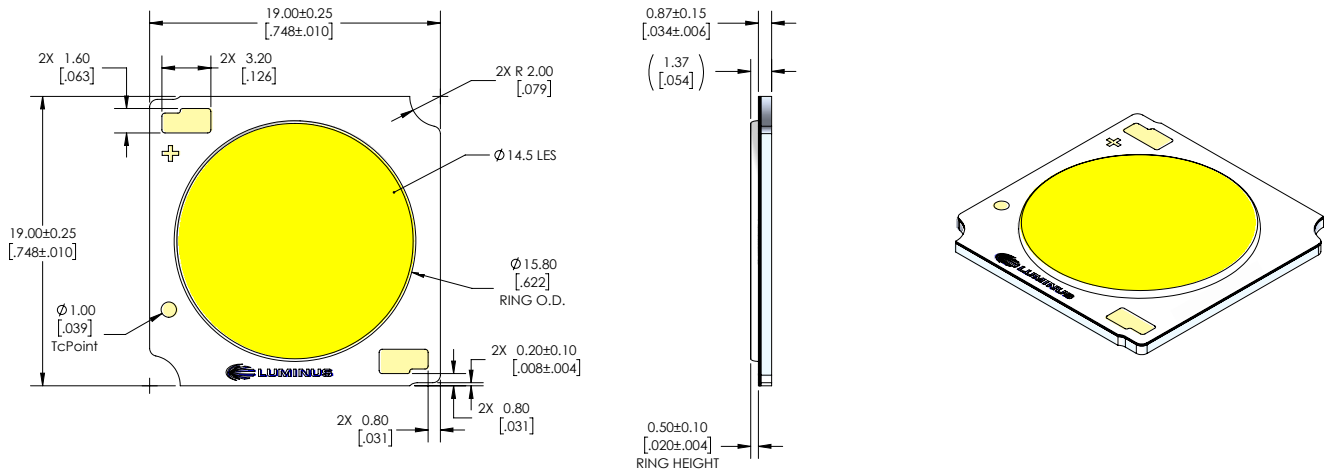

CXM-11/CIM-14/CLM-14/CXM-14/CGM-14 Series Shipping Container



Note: 45 pcs per tray and 5 trays are stacked together to be sealed in an anti-static bag.

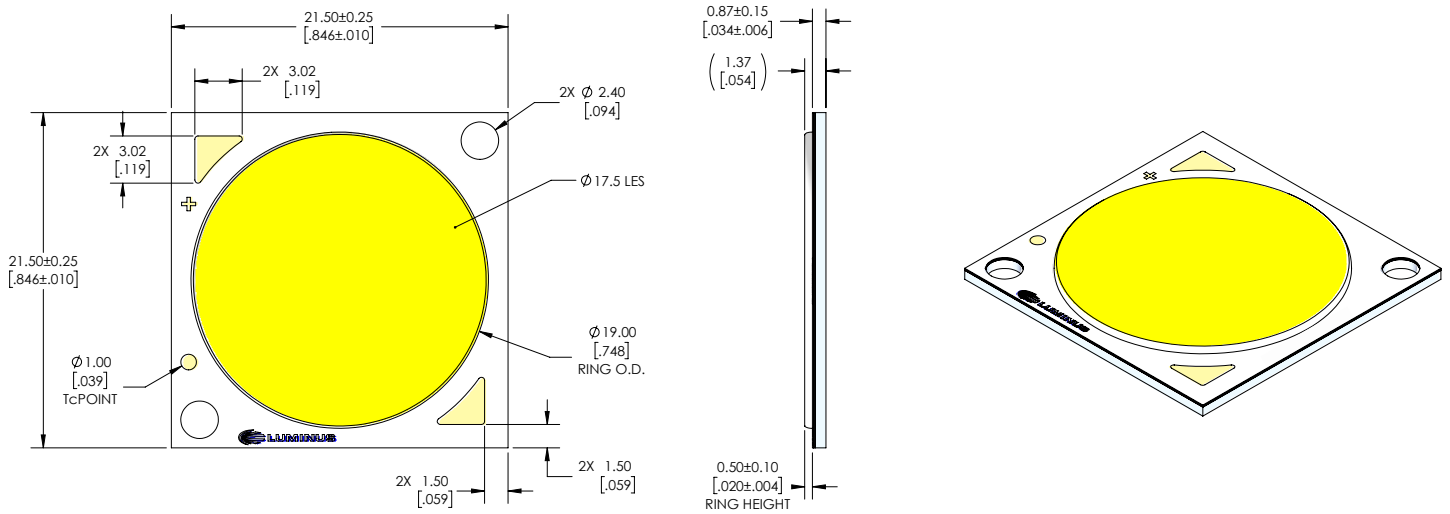

Note: The anti-static bag is boxed for easier storage, 225pcs per box.

CXM-18 Mechanical Dimensions

CXM-18 Shipping Container

Note: 36 pcs per tray and 5 trays are stacked together to be sealed in an anti-static bag.

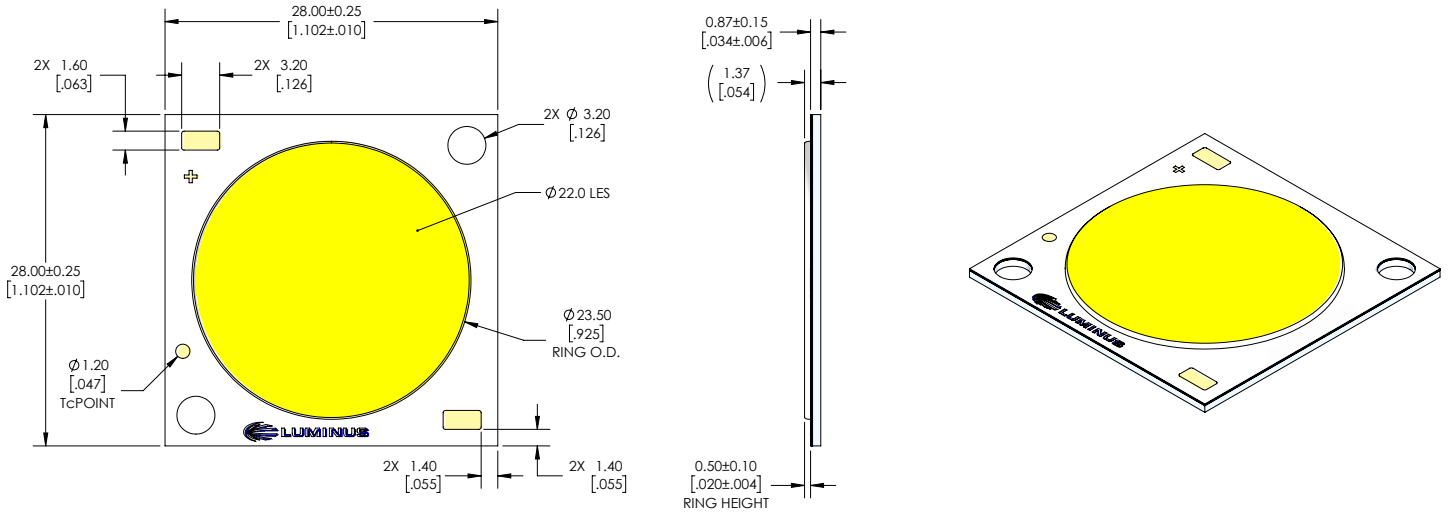

Note: The anti-static bag is boxed for easier storage, 180 pcs per box.

CIM-22/CLM-22/CXM-22/CGM-22 Mechanical Dimensions



CIM-22/CLM-22/CXM-22/CGM-22 Shipping Container



Note: 20 pcs per tray and 5 trays are stacked together to be sealed in an anti-static bag.



Note: The anti-static bag is boxed for easier storage, 100 pcs per box.

CXM-32 Mechanical Dimensions

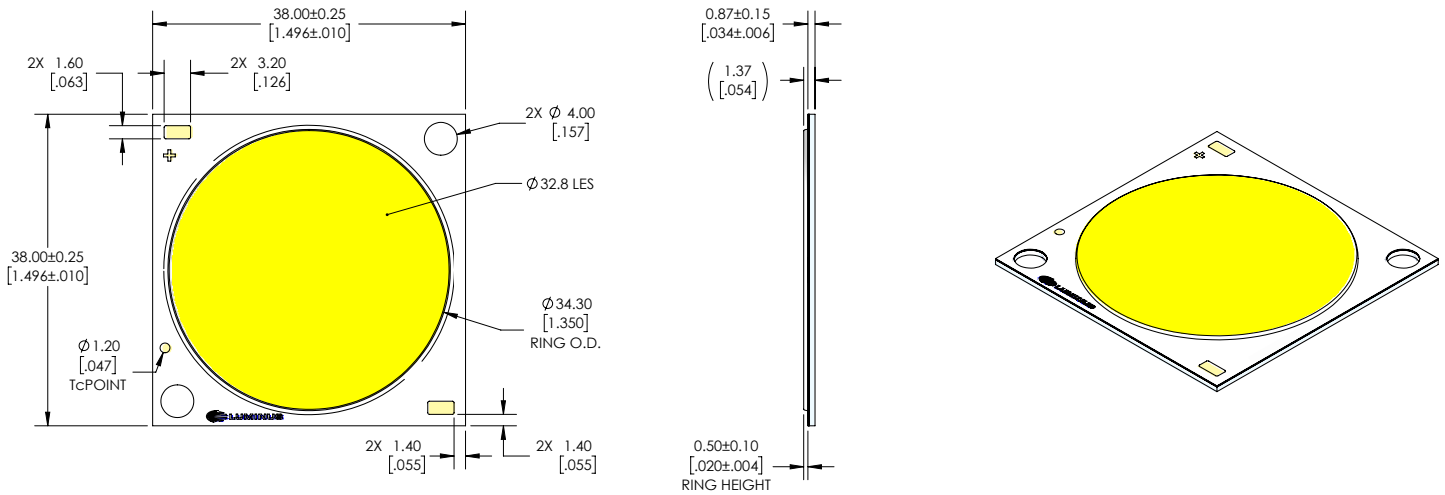

CXM-32 Shipping Container



Package model -- for illumination

Note: 20 pcs per tray and 3 trays are stacked together to be sealed in an anti-static bag.



Note: The anti-static bag is boxed for easier storage, 60 pcs per box.

Label Information

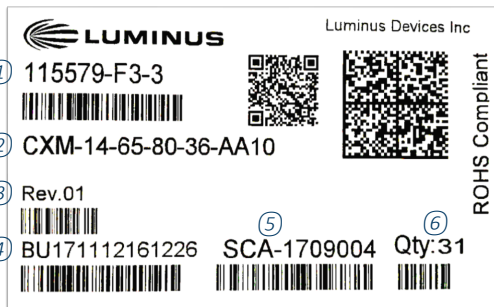

Label model -- for illumination only

Notes:

- ① Manufacture part number, flux bin and chromaticity bin
- ② Customer part number
- ③ Rev.01 indicates a fully released product
- ④ Box ID
- ⑤ Production ID
- ⑥ Total number of units in a box

Technology Overview

Luminus Chip-on-Board (COB) LED series offers a complete lighting class solution designed for high performance illumination applications. The selection covers a wide lumen range from less than 300lm to over 25,000lm, all major color temperatures and can deliver color rendering greater than 97 at 2700K and 3000K and R9 equal to 95. These breakthroughs allow illumination engineers and designers to develop lighting solutions with maximum efficacy, brightness and overall quality.

Reliability

Designed from the ground up, the Luminus COB LED is one of the most reliable light sources in the world today. Having passed a rigorous suite of environmental and mechanical stress tests, including mechanical shock, vibration, temperature cycling and humidity. Only then are the devices qualified for use in a wide range of lighting application including some of the most demanding commercial applications. Delivered with fully qualified LM80 test data and TM21 lifetime results that certify lumen maintenance at 50,000 hours or more, Luminus COB LEDs are ready for the toughest challenges.

UL Recognized Compliance

Luminus COB arrays are tested in accordance with ANSI/UL 8750 to ensure safe operation for their intended applications.

REACH & RoHS Compliance

All LED products manufactured by Luminus are REACH and RoHS compliant and free of hazardous materials, including lead and mercury

Test Specifications

Every Luminus LED is fully tested to ensure it meets the high quality standards customers have come to expect from Luminus' products.

Traceability

Each Luminus COB LED is marked with a 2D bar code that contains a unique serial number. With this serial number, Luminus has the ability to provide customers with actual test data measurements for a specific LED. In addition, the 2D bar code is linked to manufacturing date codes that enables traceability of production processes and materials.

Testing Temperature

Luminus COB products are measured at temperatures typical for the LED operating in the fixture. Each device is tested at 85°C junction temperature eliminating the need to scale data sheet specifications to real world situations.

Chromaticity Bin Range

Chromaticity binning delivers color consistency for every order. Standard products are delivered with a 3-step MacAdam ellipse. This ensures color performance matching in the application. For the most demanding application, Luminus is one of only a few companies that can provide a 2 SCDM bin distribution. These tightly controlled, small distribution bins provide customers predictable, repeatable colors.

Handling Notes

Luminus products are designed for robust performance in general lighting application. However, care must be taken when handling and assembling the LEDs into their fixtures. To avoid damaging Luminus COBs please follow these guidelines.

The following is an overview of the application notes detailing some of the practices to follow when working with these devices. More detailed information is available on the Luminus web site at www.luminus.com.

General Handling

Devices are made to be lifted or carried with tweezers on two adjacent corners opposite the contact pads. At no time should the devices be handled by or should anything come in contact with the light emitting surface (LES) area. This area includes the yellow colored circular area and the ring surrounding it. There are electrical connections under the LES which if damaged will cause the device to fail. In addition, the ring frame itself should not be used for moving, lifting or carrying the device. Also do not attach any optics or mechanical holders to the ring as it is not capable to handle the mechanical stress.

Storage Condition

Please follow the conditions below.

Before opened	Temperature 5~30 °C, relative humidity less than 60%. Note: before opened LED should be used within a year
After opened	Temperature 5~30°C, relative humidity less than 60%. Please apply soldering within one week. After opened LED should be kept in an aluminum moisture proof bag with a moisture absorbent material
Avoid corrosive gas	Avoid exposing to air with corrosive gas. If exposed, electrode surface would be damaged, which may affect soldering. Furthermore, if the device is stored in an environment which contain elements that could volatize resin material, then the volatized resin particles may stick to electrodes, which may result in connection failures.

Static Electricity

Luminus COBs are electronic devices which can be damaged by electrostatic discharge (ESD). Please use appropriate measures to assure the devices do not experience ESD during their handling and or storage. ESD protection guidelines should be used at all time when working with Luminus COBs.

Storage	Luminus products are delivered in ESD shielded bags and should be stored in these bags until used
Transporting	When transporting the devices from one assembly area to another, ESD shielded carts and carriers should be used
Assembly	Individuals handling Luminus COBs during assembly should be trained in ESD protection practices. Assemblers should maintain constant conductive contact with a path to ground by means of a wrist strap, ankle straps, mat or other ESD protection system

Chemical Compatibility

The resin material used to form the LES can get hydrocarbons from the surrounding environment. As a result, certain chemical compounds (H₂SO₄, H₂S, SO₂, NH₃, H₃PO₄ etc.) are not recommended for use with the Luminus products. Use of these compounds can cause damage to the light output of the device and may permanently damage the device. Please refer to the table below for a list of the compounds not recommended for use with the Luminus COB products.

Common Chemicals Know to Adversely Affect Luminus Devices		
Acetates	Ethers	Potassium hydroxide
Acetic acid	Cl, F or Br containing compounds	Siloxanes, fatty acids
Acrylates	Liquid hydrocarbons	Sodium Hydroxide
Aldehydes	Hydrochloric Acid	Sulfur compounds
Aldehydes	Ketones	Sulfuric Acid
Amines	Nitric Acid	Toluene
Benzene	Phosphoric acid	Xylenes
Dienes		

Thermal Interface Material (TIM)

Proper thermal management is critical for successful operation of any LED system. Excess operating temperature can reduce the light output of the device. And excessive heating can cause permanent damage to the device. Proper TIM material is a crucial component for effective heat transfer away from the LED during normal operation. Please refer to www.luminus.com for specific recommendations for TIM solutions. the compounds not recommended for use with the Luminus COB products.