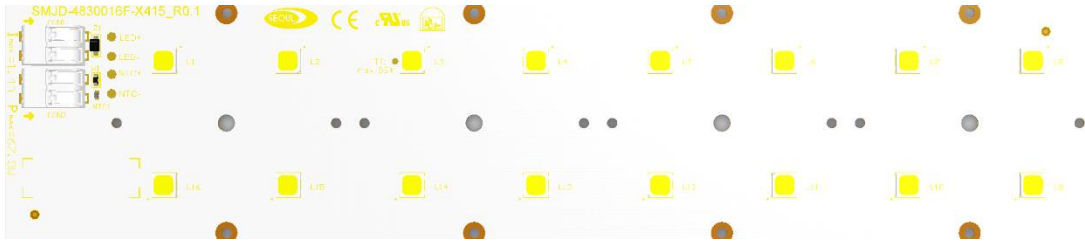

2x8 DC Module 5050

**SMJD-4830016F-X415**

## Product Brief

### Description

- This Customized module is based on White Colored surface-mount LED comes in standard package dimension.  
Package Size : 5.0x5.0x0.70mm
- The package design coupled with careful selection of component materials allow these products to perform with high reliability .

### Features and Benefits

- High Intensity output and high luminance
- High Efficacy
- Compatible with 3<sup>rd</sup> party optics
- Lead free product
- RoHS compliant
- Comply with Zhaga Book 15

### Key Applications

- Street Lighting
- Area Lighting
- Residential Lighting
- Urban Lighting

**Table 1- Order Code**

Nominal CCT (K)	CRI	Lens Type	Order Code
6500	70	-	SMJD-4830016F-X41500E86A057ALL
5700		-	SMJD-4830016F-X4150E86B057ALL
5000		-	SMJD-4830016F-X41500F26C057ALL
4000		-	SMJD-4830016F-X41500F26E057ALL
3000		-	SMJD-4830016F-X41500E86G057ALL
2700		-	SMJD-4830016F-X41500E61H057ALL
2200		-	SMJD-4830016F-X41500E39K057ALL
6500		80	-
5700	-		SMJD-4830016F-X41500E86B058ALL
5000	-		SMJD-4830016F-X41500E86C058ALL
4000	-		SMJD-4830016F-X41500E86E058ALL
3000	-		SMJD-4830016F-X41500E61G058ALL
2700	-		SMJD-4830016F-X41500E61H058ALL

---

# Table of Contents

---

Index	
-------	--

• Product Brief	
-----------------	--

• Order Code	
--------------	--

• Table of Contents	
---------------------	--

• Performance Characteristics	
-------------------------------	--

• Absolute Maximum Ratings	
----------------------------	--

• Relative Spectral Distribution	
----------------------------------	--

• Color Bin Structure	
-----------------------	--

• Mechanical Dimensions	
-------------------------	--

• Circuit Drawing	
-------------------	--

• Application Guide	
---------------------	--

• Product Nomenclature	
------------------------	--

• Marking Information	
-----------------------	--

• Label Information	
---------------------	--

• Packing Introduction	
------------------------	--

• Precaution for Use	
----------------------	--

• Storage before use	
----------------------	--

• Guidelines for properly working with module	
---	--

• Company Information	
-----------------------	--

• Revision History	
--------------------	--

---

## Performance Characteristics

**Table 2. Electro Optical Characteristics, T<sub>c</sub> =25°C, I<sub>F</sub>= 650mA [1]**

Parameter	Symbol	Value			Unit	Remark 1	Remark 2
		Min.	Typ.	Max.			
Luminous Flux	Φ <sub>V</sub> [2]	4890	5260	-	Lm	C,E Rank	CRI 70
		4520	4860	-		A,B,G Rank	
		4290	4610	-		H Rank	
		4080	4390	-		K Rank	
		4520	4860	-	Lm	A,B,C,E Rank	CRI 80
		4290	4610	-	G,H Rank		
Luminous Efficiency	LPW	-	175	-	Lm/W	C,E Rank	CRI 70
		-	162	-		A,B,G Rank	
		-	154	-		H Rank	
		-	146	-		K Rank	
		-	162	-	Lm/W	A,B,C,E Rank	CRI 80
		-	154	-	G,H Rank		
Correlated Color Temperature [3]	CCT	6000	6500	7000	K	A rank	
		5300	5700	6000		B rank	
		4700	5000	5300		C rank	
		3700	4000	4200		E rank	
		2900	3000	3200		G rank	
		2600	2700	2900		H rank	
		2100	2200	2300		K rank	
CRI	Ra	70	-	-	-		CRI 70
		80	-	-			CRI 80
Color Consistency	SDCM	-	-	5	-		
Forward Voltage	V <sub>in</sub>	43	46.1	49	V <sub>dc</sub>		
Input Current	I <sub>F</sub>	-	650	-	mA		
Power Consumption	P		30.0		W		
Viewing Angle	2Θ <sub>1/2</sub>		120		deg.		

**Notes :**

- (1) The above data were tested at T<sub>c</sub>=25°C.
- (2) Φ<sub>V</sub> is the total luminous flux output measured with an integrated sphere, the tolerance is 7% .
- (3) Correlated Color Temperature is derived from the CIE 1931 Chromaticity diagram.
- (4) To use the module properly, recommend to drive the module by a Constant Current Source (CCS). But the Maximum output voltage of the CCS should be limited by referring this datasheet.

## Absolute Maximum Ratings

**Table 3. Absolute Maximum Ratings,  $I_F=650\text{mA}$ ,  $T_c=25^\circ\text{C}$  <sup>(1)</sup>**

Parameter	Symbol	Unit	Value	Remark
Power Consumption	P	W	67.9	$P_{Typ.} = 30.0\text{W}$
Driving Current <sup>(2)</sup>	$I_F$	mA	1400	$I_{F\_Typ.} = 650\text{mA}$
Operating Temperature <sup>(3)</sup>	$T_c$	$^\circ\text{C}$	- 40 ~ 85	Reference point
Storage Temperature	$T_{stg}$	$^\circ\text{C}$	- 40 ~ 100	With no power
ESD Sensitivity	-	KV	$\pm 15$	IEC Air
			$\pm 8$	HBM

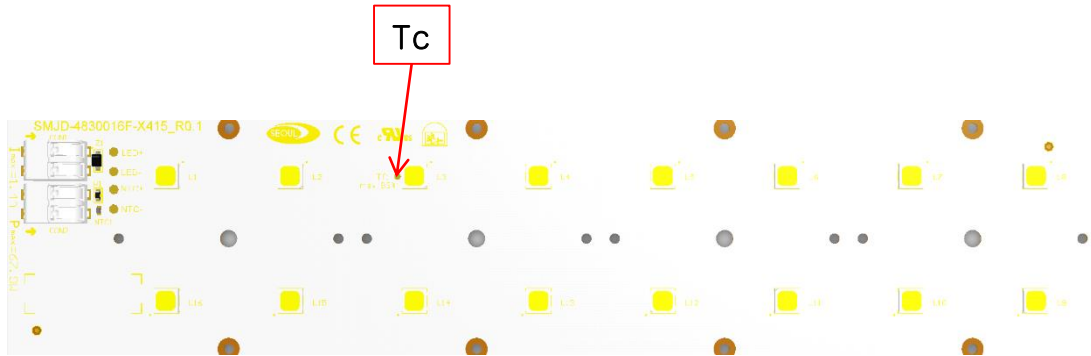
**ILLUSTRATION 1: How to predict components temperature <sup>(4)</sup>**

**Notes :**

- (1) All guarantee are based on the Absolute Maximum Ratings listed.
- (2) Please use a Constant Current Source (CCS) to drive the module, the typical  $V_F$  of module is around 46.1VDC and  $V_{F\_MAX}$  is around 49VDC, respectively.
- (3) Operating temperature was tested at the assigned  $T_c$  point on the PCB.
- (4) To ensure the module works properly, DO NOT let the  $T_c$  upper than 85  $^\circ\text{C}$ ;

## Relative Spectral Distribution

Fig 1. Relative Spectral Distribution vs. Wavelength Characteristic

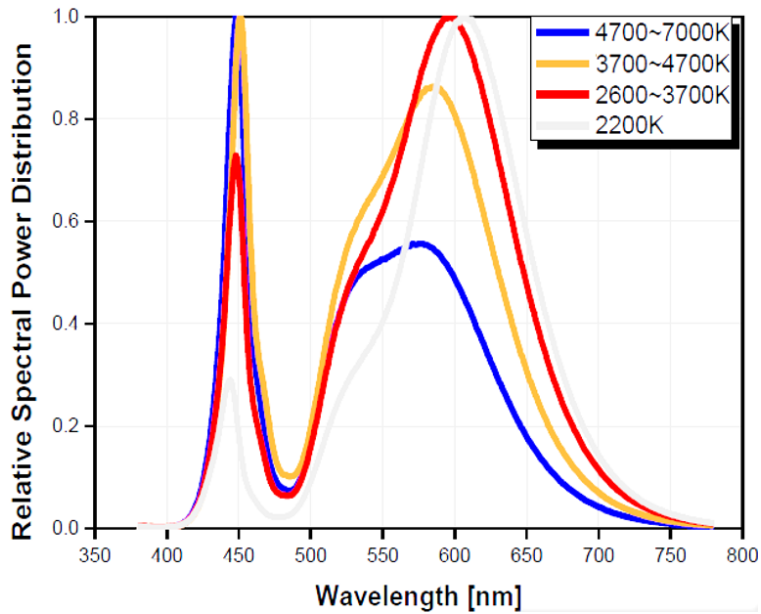
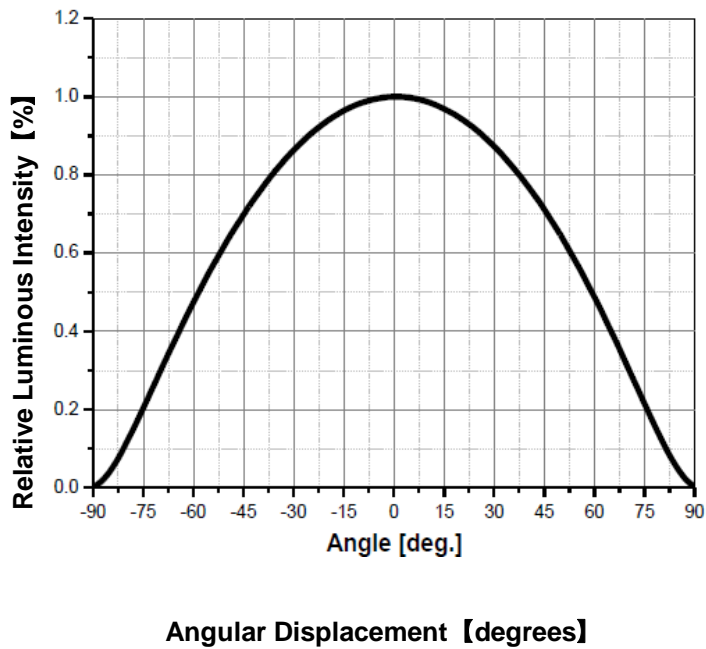

Fig 2. Typical Spatial Distribution



## Relative Spectral Distribution

Fig 3. Flux and Efficacy vs. Temperature at  $T_c$ (at  $I_f=650\text{mA}$ )

$T_c$ [°C]	Flux[%]	Efficacy[%]
25	100	100
45	97	98
65	93	95
85	90	92

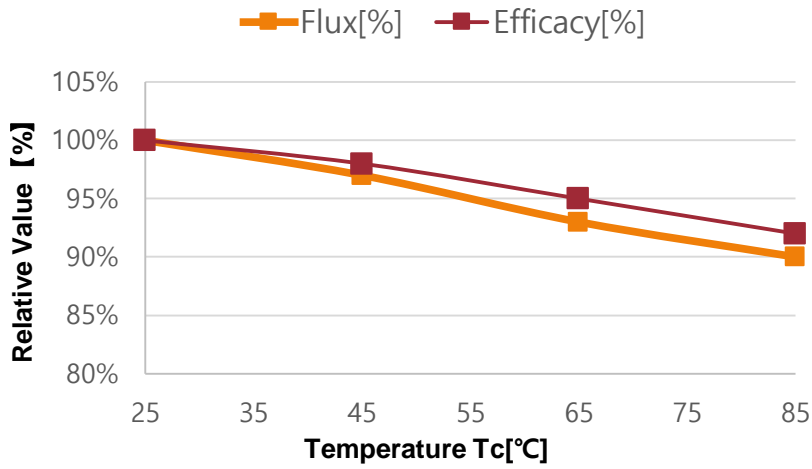
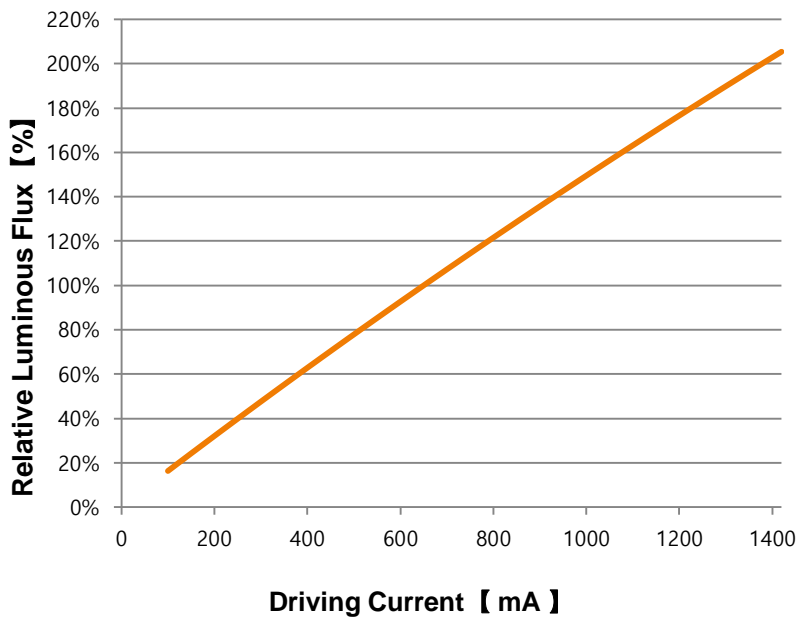
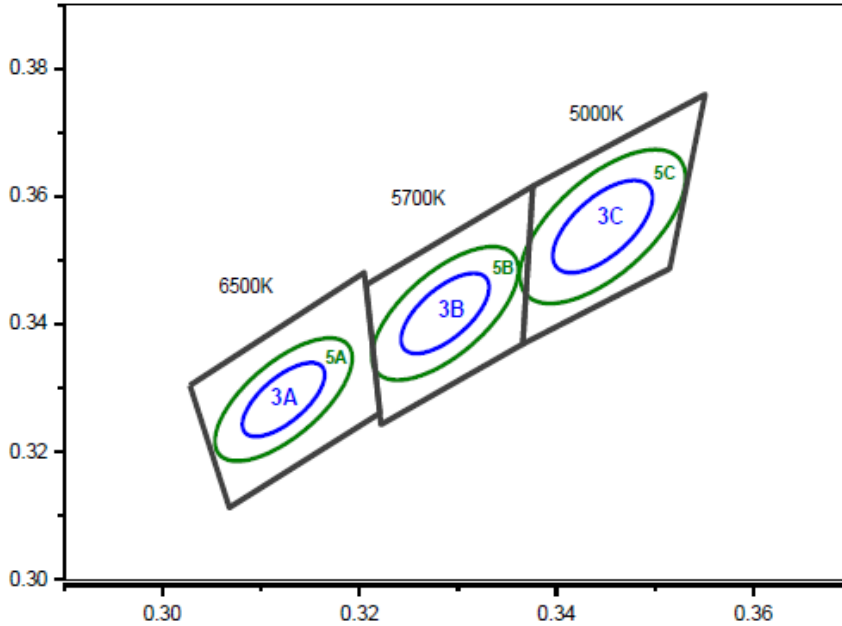

Fig 4. Forward Current vs. Relative Luminous Flux,  $T_c=25^\circ\text{C}$



## Color Bin Structure

Fig 5. CIE Chromaticity Diagram



6500K 3Step		5700K 3Step		5000K 3Step	
3A		3B		3C	
Center point	0.3123 : 0.3282	Center point	0.3287 : 0.3417	Center point	0.3447 : 0.3553
Major Axis a	0.0066	Major Axis a	0.0071	Major Axis a	0.0081
Minor Axis b	0.0027	Minor Axis b	0.003	Minor Axis b	0.0035
Ellipse Rotation Angle	58	Ellipse Rotation Angle	59	Ellipse Rotation Angle	60

  

6500K 5Step		5700K 5Step		5000K 5Step	
5A		5B		5C	
Center point	0.3123 : 0.3282	Center point	0.3287 : 0.3417	Center point	0.3447 : 0.3553
Major Axis a	0.0110	Major Axis a	0.0118	Major Axis a	0.0135
Minor Axis b	0.0045	Minor Axis b	0.0050	Minor Axis b	0.0058
Ellipse Rotation Angle	58	Ellipse Rotation Angle	59	Ellipse Rotation Angle	60



## Color Bin Structure

Fig 6. CIE Chromaticity Diagram

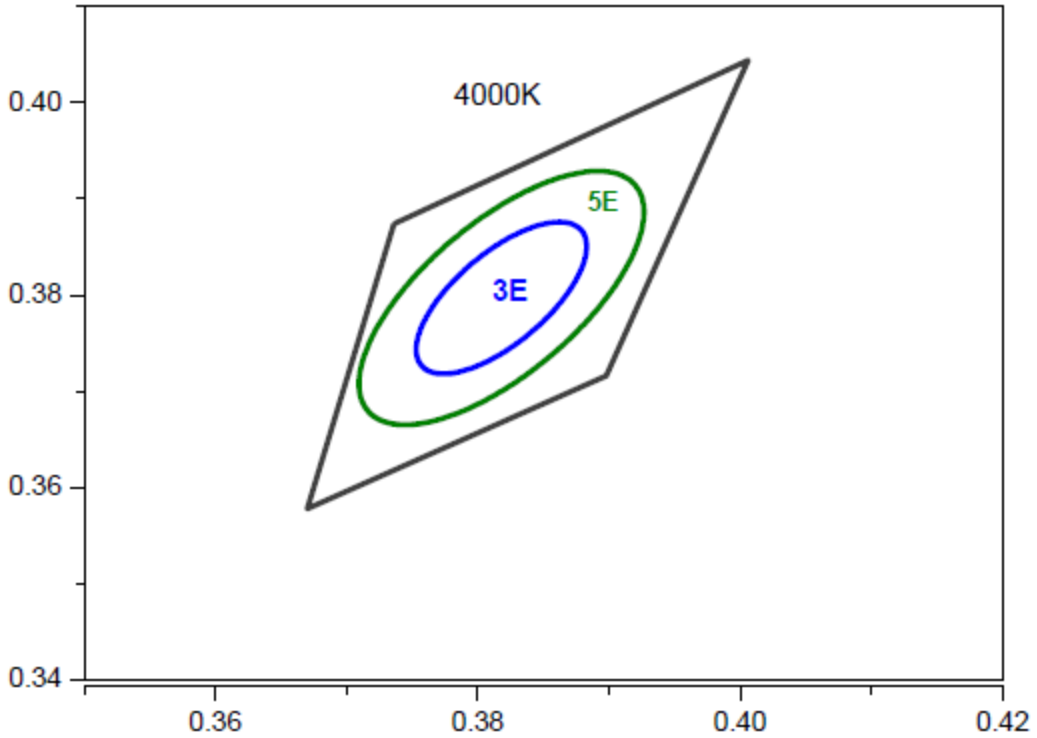

### 4000K 3Step

3E	
Center point	0.3818 : 0.3797
Major Axis a	0.00940
Minor Axis b	0.00400
Ellipse	
Rotation Angle	53

### 4000K 5Step

5E	
Center point	0.3818 : 0.3797
Major Axis a	0.0157
Minor Axis b	0.0067
Ellipse	
Rotation Angle	53

## Color Bin Structure

Fig 7. CIE Chromaticity Diagram

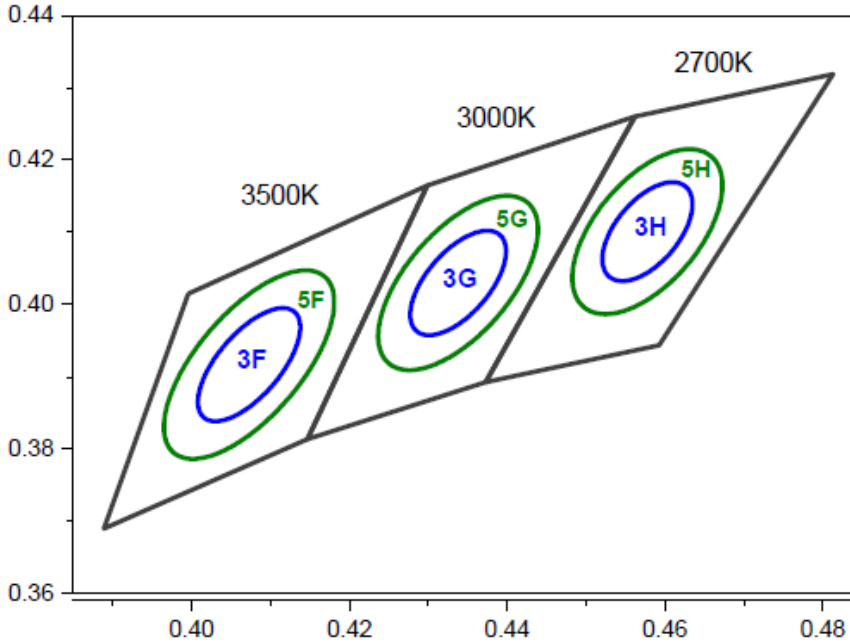

3500K 3Step		3000K 3Step		2700K 3Step	
3F		3G		3H	
Center point	0.4073 : 0.3917	Center point	0.4338 : 0.4030	Center point	0.4578 : 0.4101
Major Axis a	0.0093	Major Axis a	0.0085	Major Axis a	0.0079
Minor Axis b	0.0041	Minor Axis b	0.0041	Minor Axis b	0.0041
Ellipse Rotation Angle	53	Ellipse Rotation Angle	53	Ellipse Rotation Angle	54

3500K 5Step		3000K 5Step		2700K 5Step	
5F		5G		5H	
Center point	0.4073 : 0.3917	Center point	0.4338 : 0.4030	Center point	0.4578 : 0.4101
Major Axis a	0.0155	Major Axis a	0.0142	Major Axis a	0.0132
Minor Axis b	0.0068	Minor Axis b	0.0068	Minor Axis b	0.0068
Ellipse Rotation Angle	53	Ellipse Rotation Angle	53	Ellipse Rotation Angle	54

## Color Bin Structure

Fig 8. CIE Chromaticity Diagram

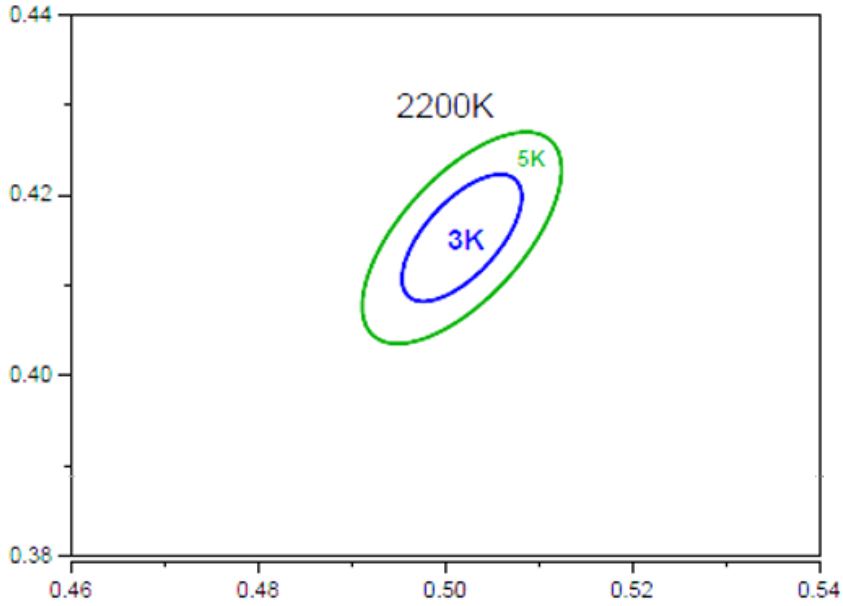

### 2200K 3Step

3K	
Center point	0.5018 : 0.4153
Major Axis a	0.00863
Minor Axis b	0.00398
Ellipse Rotation Angle	49

### 2200K 5Step

5K	
Center point	0.5018 : 0.4153
Major Axis a	0.01438
Minor Axis b	0.00663
Ellipse Rotation Angle	49

## Mechanical Dimensions

Fig 9.mechanical dimensions

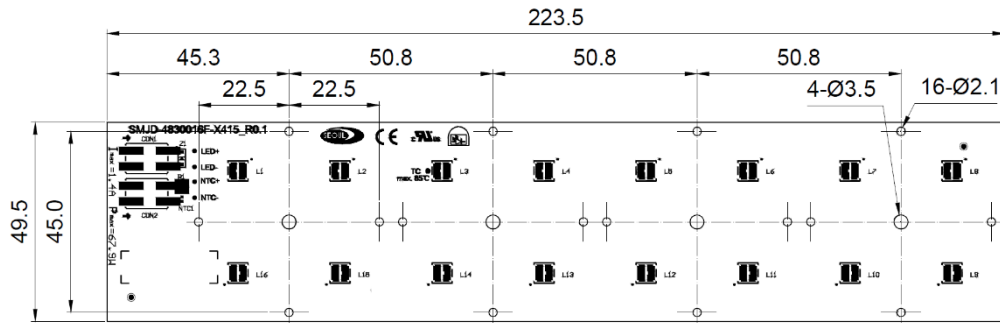

## Circuit Drawing

Fig 10. circuit drawing

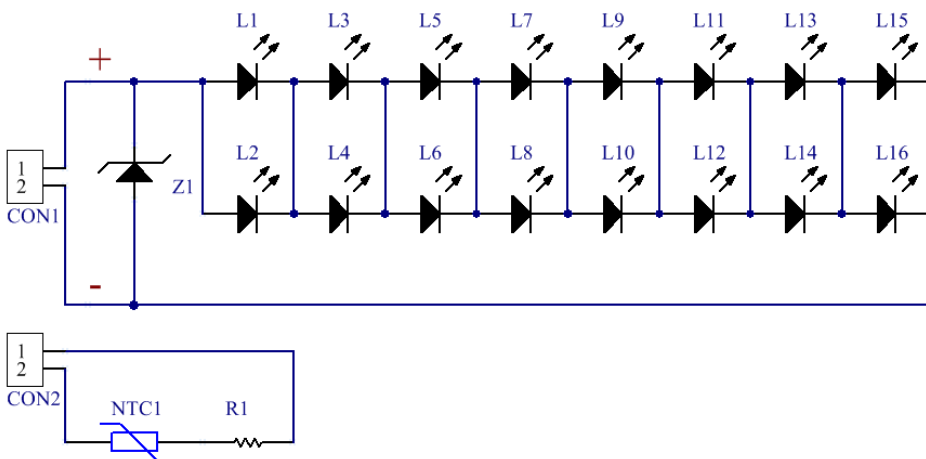

**Notes :**

- (1) All dimensions are in millimeters.
- (2) Scale : None
- (3) Module thickness :  $1.6 \pm 0.1$

## Application Information

### a). Connection between driver and module

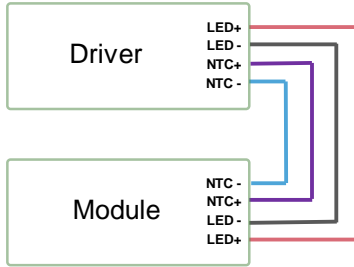

### b). Multiple module on one driver

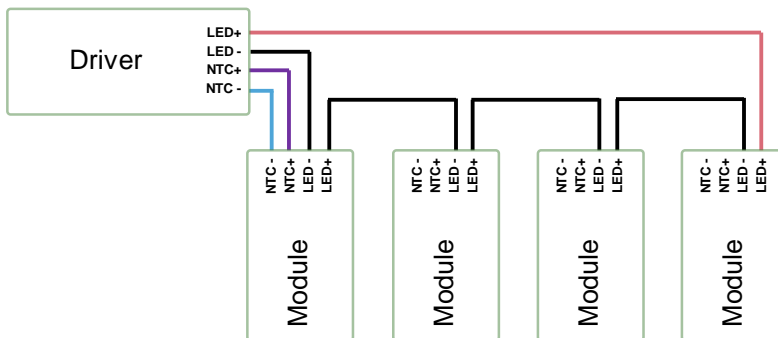

### c). To use a driver with multi output channels for group application

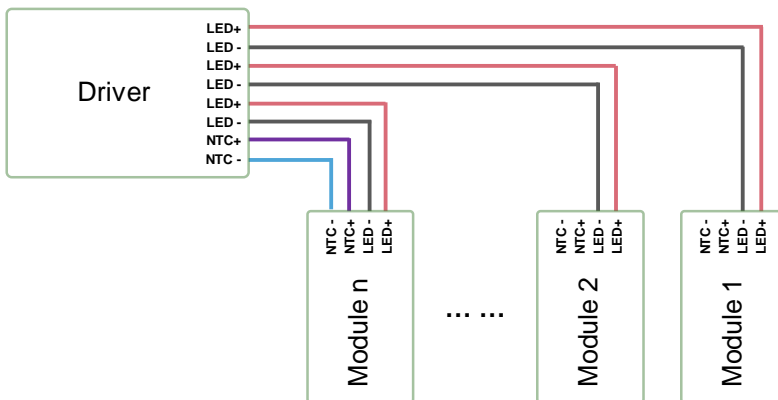

**Notes :**

- (1) In case of all modules have to be in parallel for a group application, 3 is the max quantity in parallel

## Application Information

### a). Application

IP rating	No IP-rating
Over Temperature Detection	A resistor and NTC in series, where $R=2K\Omega$ , $R_{NTC}=15K\ \Omega$
Luminaire Class	IEC Class I and Class II
Dimming	Yes

## Product Nomenclature

Product Name Rule:

**S M J D - 48 30 016 F - X 4 15**  
 ①                      ②                      ③                      ④                      ⑤                      ⑥                      ⑦                      ⑧

①: SMJD – Seoul DC Module  
 ② ~ ⑧: Refer to below table

Voltage				Power				LED Qty.				LED Type	Customer (Free)	CNT	FREE						
②		③		④				⑤	⑥		⑦		⑧								
4	8	3	0	0	1	6	F	X		4		15									
0	0	0	0	0	0	0	0	0	0	0	0	0	F	5050	X	Reference	4	4way	15	Zhaga Book 15	
1	10V	1	1V	1	10W	1	1W	1	100EA	1	10EA	1	1EA								
2	20V	2	2V	2	20W	2	2W	2	200EA	2	20EA	2	2EA								
3	30V	3	3V	3	30W	3	3W	3	300EA	3	30EA	3	3EA								
...	...	...	...	...	...	...	...	...	...	...	...	...									
9	90V	9	9V	9	90W	9	9W	9	900EA	9	90EA	9	9EA								
A	100V			A	100W			A	1000EA												
B	110V			B	110W																
...	...			...	...																
Z	350V			Z	350W																

Comments Rule:

**( 00 WN 70 )**  
**A                      B                      C**

Lens Type		CCT		CRI	
A		B		C	
00		W0		70	
00	No lens	W0	6500K	70	CRI70
			5700K	80	CRI80
			5000K		
		WN	4000K		
		WW	3000K		
			2200K		

## Product Nomenclature

Characteristics Rule:

00   F26   E05   7   All  
**A**   **B**   **C**   **D**   **E**

Lens type		Flux bin		CCT bin		CRI bin		VF Bin <sup>(1)</sup>	
A		B		C		D		E	
00		F26		E05		7		ALL	
00	No lens	F26	5260 lm	A05	6500K 5-step	7	CRI70	ALL	VF: ALL
		E86	4860 lm	B05	5700K 5-step	8	CRI80		
		E61	4610 lm	C05	5000K 5-step				
		E39	4390 lm	E05	4000K 5-step				
				G05	3000K 5-step				
				H05	2700K 5-step				
				K05	2200K 5-step				



# Marking Information

Fig 11. Marking Point

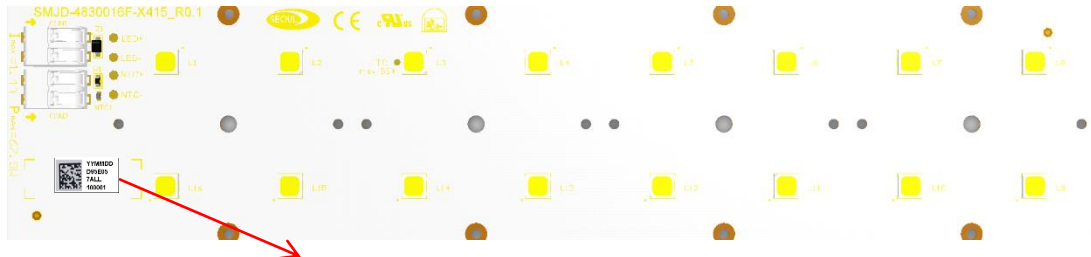

Marking point

QR Code Information



YYMMDD  
F26E05  
7ALL  
100001

- ①
- ②
- ③
- ④

QR Code Information								
Items	Factory	SAP Code	SMT Date	Rank Information	Line No.	Lot No.	Product	Notes
Digits	1 Digit	7 Digit	6 Digit	10 Digit	1 Digit	1 Digit	5 Digit	In Total 31 Digits
Information	*	*****	YYMMDD D	F26E05 7ALL	1~9, A~Z	1~9, A~Z	00001	

## Plain Code Information















No.	Item	Information	Digits	Remark	
①	Date	YYMMDD	6Digit	SMT date	
②	Flux <sup>(1)</sup>	F26	3Digit	F26=5260lm	
		E86		E86=4860lm	
		E39		E39=4390lm	
		E61		E61=4610lm	
	CCT	X05	5- step	3Digit	X=A,B,C,E,G,K
③	CRI	7	1Digit	CRI=70	
		8	1Digit	CRI=80	
	V <sub>F</sub>	ALL	3Digit	V <sub>F</sub> : ALL	
④	Lot No.	1	1 Digit	0~9,A~Z	
	Sequence No.	00001	5 Digit	00001 ~ 99999	

**Notes :** # This product 5-step mixing can use different flux Bin

(1) Module Flux code rule as below table



Symbol	Im	Symbol	Im	Symbol	Im	Symbol	Im
D91	3910	O50	14500	R50	17500	U50	20500
M20	12200	P50	15500	S50	18500	V20	21200
N00	13000	Q50	16500	T50	19500	W00	22000

## Label Information

<b>PO Number</b> 	<b>XXXXXX (1)</b> 
<b>Supplier Part Number</b> 	<b>SMJD-4830016F-X41500F26E057ALL (2)</b> 
<b>Bin Code</b> 	<b>F26E057ALL (3)</b> 
<b>Quantity</b> 	<b>XX</b> 
<b>Country of Origin</b> 	<b>XX (4)</b> 
<b>Date Code</b> 	<b>YYYYWW (5)</b> 
<b>Lot Code</b> 	<b>YYMDDXXXXX- XXXXXXXX (6)</b> 
	<b>SEOUL SEMICONDUCTOR CO.,LTD.</b>

**Notes**

- (1) This is customer's PO Number
- (2) Please refer to SPEC page 15 (30 digit code)
- (3) Please refer to SPEC page 16
- (4) Country of Origin: 2 digit code . For example : Chinese Code: CN
- (5) Date Code : YYYYWW : Packing Date: Year + Week
- (6) Lot Code :  
 Initial of manufacture is refer to the 2D code rule.  
 YYMDD : Packing Date (Oct. : A, Nov. : B, Dec. : C)  
 X : Initial of Manufacturer  
 XXXX : Sealing Pack No.  
 XXXXXXXX : SSC SAP Code
- (7) It is attached to the top left corner of the box.

<b>TOTAL Quantity</b>   <b>XXX</b>
 <b>SEOUL SEMICONDUCTOR CO.,LTD</b>

**Notes**

- (1) It is attached to the bottom right corner of the carton box.

## Packaging Specification

Model	Tray		Box		Pallet	
	Size (mm)	Q'ty per tray (ea)	Size (mm)	Q'ty per box (ea)	Size (mm)	Q'ty per pallet (ea)
SMJD-4830016F-X415	580 x 430 x 30	24	600 x 448 x 202	216	1100 x 1100	4320

Note:  
 1box=9trays(+1dummy)=216ea  
 1pallet=20box(4box\*5layer=20box)=4320ea

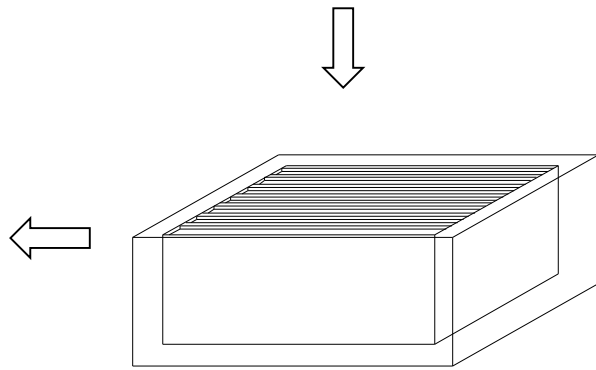
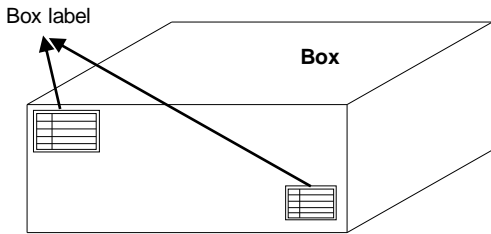
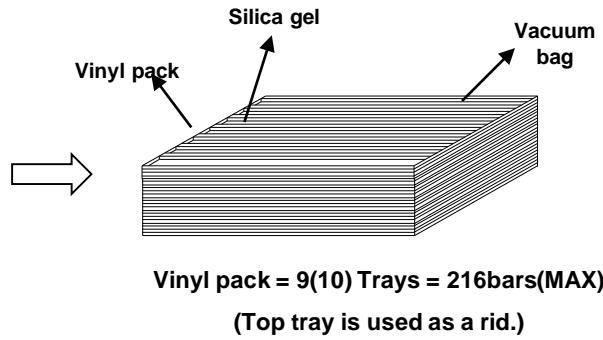
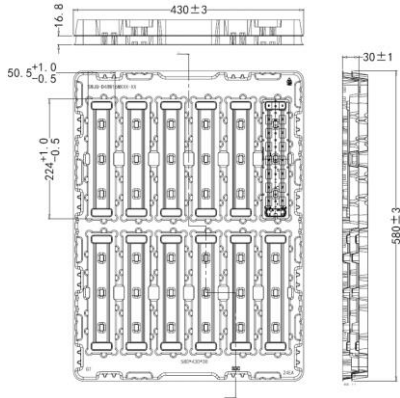

**1 Box = 9(10) Trays = 216bars (MAX)**

## Precaution for Use

- (1) Check the appearance of module before wiring/ assembly, DO NOT use the LED cracked or PCB damaged module.
- (2) The module was designed to be driven with DC source, recognize the polarities of the module was necessity.
- (3) It was SELV module, DO NOT connect the LED directly to main power during wiring.
- (4) DO NOT let the LED packages contacted with any hard matters.
- (5) There was no current regulator built in module, unevenly load between different parallel modules may occur due to the modules  $V_f$  variance .
- (6) Please do not use together with the materials containing Sulfur.
- (7) Please do not make any modification on module.

## Precaution for Use

(8) LEDs are sensitive to Electro-Static Discharge (ESD) and Electrical Over Stress (EOS).

Below is a list of suggestions that Seoul Semiconductor purposes to minimize these effects.

a. ESD (Electro Static Discharge)

Electrostatic discharge (ESD) is defined as the release of static electricity when two objects come into contact. While most ESD events are considered harmless, it can be an expensive problem in many industrial environments during production and storage. The damage from ESD to an LEDs may cause the product to demonstrate unusual characteristics such as:

- Increase in reverse leakage current lowered turn-on voltage
- Abnormal emissions from the LED at low current

The following recommendations are suggested to help minimize the potential for an ESD event:

One or more recommended work area suggestions:

- Ionizing fan setup
- ESD table/shelf mat made of conductive materials
- ESD safe storage containers

One or more personnel suggestion options:

- Antistatic wrist-strap
- Antistatic material shoes
- Antistatic clothes

Environmental controls

- Humidity control (ESD gets worse in a dry environment)

b. EOS (Electrical Over Stress)

Electrical Over-Stress (EOS) is defined as damage that may occur when an electronic device is subjected to a current or voltage that is beyond the maximum specification limits of the device.

The effects from an EOS event can be noticed through product performance like:

Changes to the performance of the LED package (If the damage is around the bond pad area and since the package is completely encapsulated the package may turn on but flicker show severe performance degradation.)

Changes to the light output of the luminaire from component failure

Components on the board not operating at determined drive power

Failure of performance from entire fixture due to changes in circuit voltage and current across total circuit causing trickle down failures

It is impossible to predict the failure mode of every LED exposed to electrical overstress as the failure modes have been investigated to vary, but there are some common signs that will indicate an EOS event has occurred.

- Damaged may be noticed to the bond wires (appearing similar to a blown fuse).
- Damage to the bond pads located on the emission surface of the LED package (shadowing can be noticed around the bond pads while viewing through a microscope).
- Anomalies noticed in the encapsulation and phosphor around the bond wires.
- This damage usually appears due to the thermal stress produced during the EOS event.

c. To help minimize the damage from an EOS event Seoul Semiconductor recommends utilizing

- qualified LED driver with no big over shoot out put
- Isolated driver that to prevent harmful peaks passed to module.
- A current limiting device

## Storage before use

- (1) Do not impact or place pressure on this product because even a small amount of pressure can damage the product. The product should also not be placed in high temperatures, high humidity or direct sunlight since the device is sensitive to these conditions.
- (2) When storing devices for a long period of time before usage, please following these guidelines:
  - \* The devices should be stored in the anti-static bag that it was shipped in from Seoul-Semiconductor with opening.
  - \* If the anti-static bag has been opened, re-seal preventing air and moisture from being present in the bag.

## **Guidelines for properly working with Module**

- (1) Discharge the lighting system a minimum of 2-3 times prior to working with the module.
- (2) Use only properly rated test equipment and tools for the rated voltage and current of the product being tested.
- (3) It is strongly suggested to wear rubber insulated gloves and rubber bottom shoes.
- (4) Do not wear any conductive items (such as jewelry) which could accidentally contact electric circuits.
- (5) Perform several tests with power off and the lighting system unplugged.
- (6) Faults, lightning, or switching transients can cause voltage surges in excess of the normal ratings.
- (7) Internal component failure can cause excessive voltages.
- (8) Stored or residual electricity in long wire could be hazardous.
- (9) Make sure proper discharge prior to starting work.

## Company Information

### Published by

Seoul Semiconductor © 2013 All Rights Reserved.

### Company Information

Seoul Semiconductor (SeoulSemicon.com) manufactures and packages a wide selection of light emitting diodes (LEDs) for the automotive, general illumination/lighting, appliance, signage and back lighting markets. The company is the world's fifth largest LED supplier, holding more than 10,000 patents globally, while offering a wide range of LED technology and production capacity in areas such as "nPola", deep UV LEDs, "Acrich", the world's first commercially produced AC LED, and "Acrich MJT - Multi-Junction Technology" a proprietary family of high-voltage LEDs. The company's broad product portfolio includes a wide array of package and device choices such as Acrich, high-brightness LEDs, mid-power LEDs, side-view LEDs, through-hole type LED lamps, custom displays, and sensors. The company is vertically integrated from epitaxial growth and chip manufacture in its fully owned subsidiary, Seoul Viosys, through packaged LEDs and LED modules in three Seoul Semiconductor manufacturing facilities. Seoul Viosys also manufactures a wide range of unique deep-UV wavelength devices.

### Legal Disclaimer

Information in this document is provided in connection with Seoul Semiconductor products. With respect to any examples or hints given herein, any typical values stated herein and/or any information regarding the application of the device, Seoul Semiconductor hereby disclaims any and all warranties and liabilities of any kind, including without limitation, warranties of non-infringement of intellectual property rights of any third party. The appearance and specifications of the product can be changed to improve the quality and/or performance without notice.



## Revision History

Revision	Date	Page	Remarks
R0.1	2020.03.27	All	Preliminary data sheet for SMJD-4830016F-X415
R0.2	2020.04.21	19	Update the packing information