



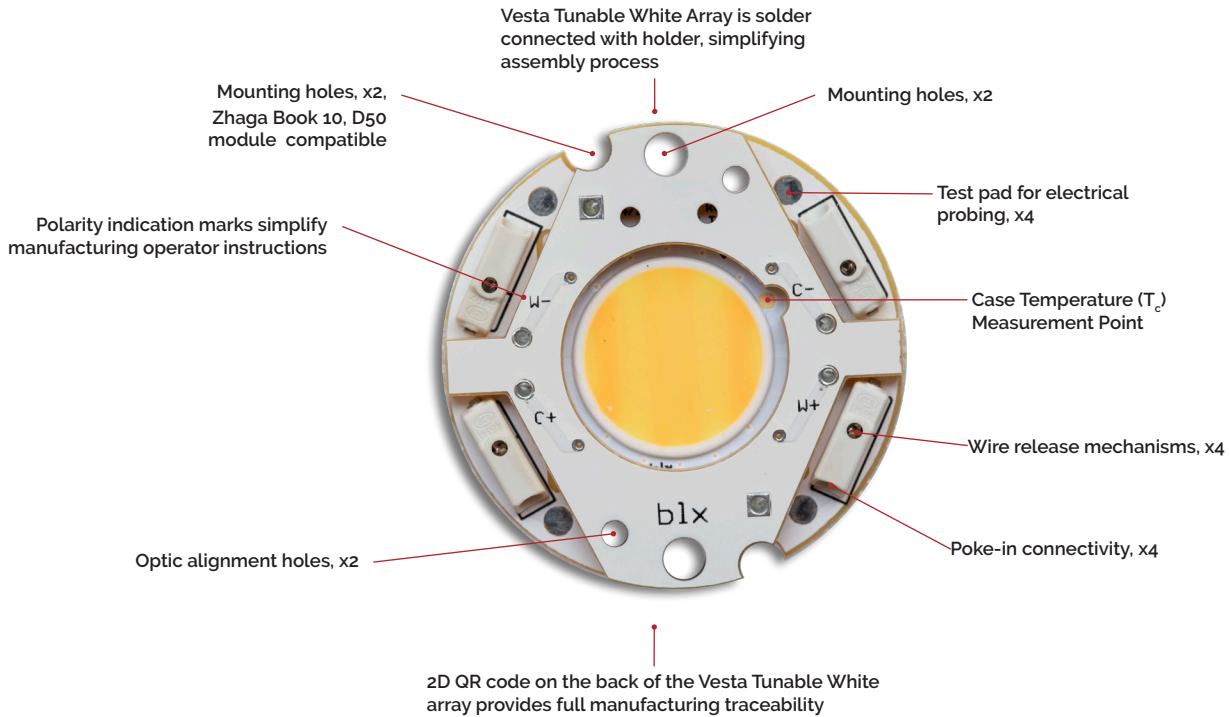
# Bridgelux® Vesta®SE Series Tunable White Gen 2 13mm Integrated Array with S2 Holder

Product Data Sheet DS362



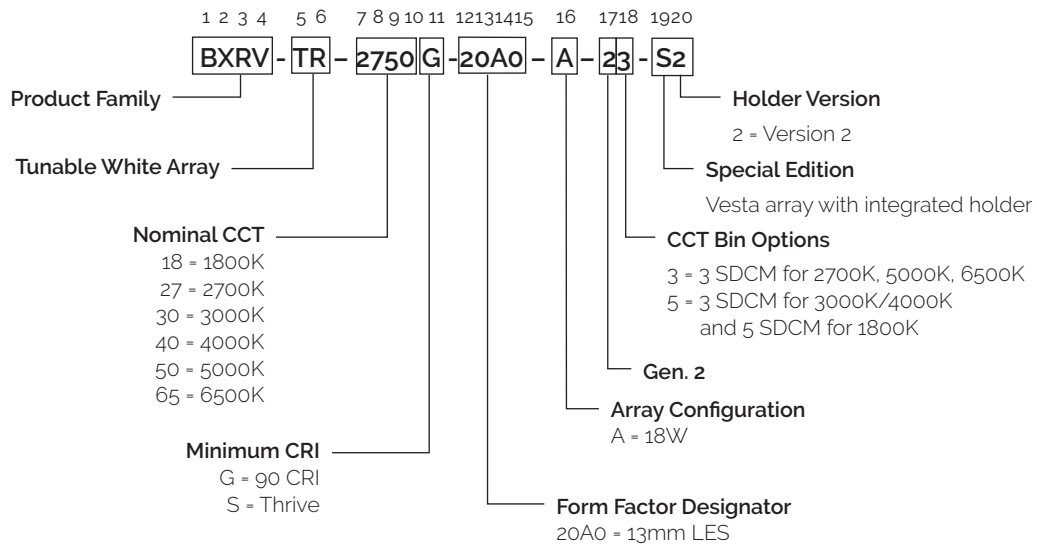
# Product Feature Map

Bridgelux arrays are fully engineered devices that provide consistent thermal and optical performance on an engineered mechanical platform. The arrays incorporate several features to simplify design integration and assembly. Please visit [www.bridgelux.com](http://www.bridgelux.com) for more information on the Vesta SE Series family of products.



## Product Nomenclature

The part number designation for Bridgelux Vesta SE Series arrays is explained as follows:



# Product Selection Guide

The following product configurations are available:

**Table 1:** Selection Guide, Measurement Data

Part Number	Nominal CCT <sup>1</sup> T <sub>c</sub> =85°C (K)	Typical CRI <sup>2</sup> T <sub>c</sub> =85°C	Nominal Drive Current, per channel (mA)	Typical V <sub>f</sub> <sup>3</sup> T <sub>c</sub> =25°C (V)	Typical Power T <sub>c</sub> =25°C (W)	Typical Pulsed Flux <sup>3, 4, 5</sup> T <sub>c</sub> =25°C (lm)	Typical Efficacy T <sub>c</sub> =25°C <sup>5</sup> (lm/W)	Minimum Pulsed Flux <sup>8</sup> T <sub>c</sub> =25°C (lm)	Typical DC Flux T <sub>c</sub> =85°C <sup>6, 7</sup> (lm)
BXRV-TR-2750G-20A0-A-23-S2	2700	93	500	35.2	17.6	1871	106	1684	1647
	5000	92	500	36.3	18.2	2119	117	1907	1843
BXRV-TR-2765G-20A0-A-23-S2	2700	93	500	35.2	17.6	1871	106	1684	1647
	6500	92	500	36.3	18.2	2119	117	1907	1843
BXRV-TR-2750S-20A0-A-23-S2	2700	98, Thrive	500	35.2	17.6	1604	91	1443	1427
	5000	98, Thrive	500	36.3	18.2	1860	102	1674	1674
BXRV-TR-2765S-20A0-A-23-S2	2700	98, Thrive	500	35.2	17.6	1628	93	1465	1449
	6500	98, Thrive	500	36.3	18.2	1901	105	1711	1711
BXRV-TR-1830G-20A0-A-25-S2	1800	92	500	35.2	17.6	1262	72	1136	1111
	3000	92	500	36.3	18.2	1880	104	1692	1636
BXRV-TR-1840G-20A0-A-25-S2	1800	92	500	35.2	17.6	1262	72	1136	1111
	4000	92	500	36.3	18.2	1993	110	1794	1734

**Notes for Table 1:**

- Nominal CCT as defined by ANSI C78.377-2017.
- For CRI 92-93 products, the minimum CRI value is 90 and the minimum R<sub>g</sub> value is 50. For CRI 98 Thrive products, the minimum CRI value is 95. Bridgelux maintains a ±3 tolerance on all R<sub>g</sub> values.
- Products tested under pulsed condition (10ms pulse width) at nominal test current where T<sub>j</sub> (junction temperature) - T<sub>c</sub> (case temperature) = 25°C.
- Typical performance values are provided as a reference only and are not a guarantee of performance.
- Bridgelux maintains a ±7% tolerance on flux measurements.
- Typical stabilized DC performance values are provided as reference only and are not a guarantee of performance.
- Typical performance is estimated based on operation under DC (direct current) with LED array mounted onto a heat sink with thermal interface material and the case temperature maintained at 85°C. Based on Bridgelux test setup, values may vary depending on the thermal design of the luminaire and/or the exposed environment to which the product is subjected.
- Minimum flux values at nominal test current are guaranteed by 100% test.

# CRI and TM30 Characteristics for Vesta SE with Thrive

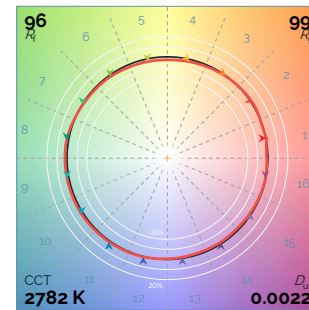
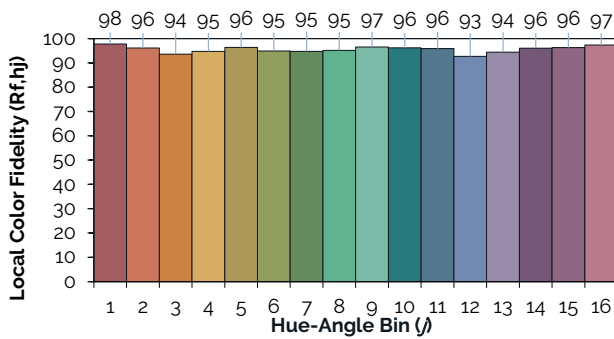
**Table 2:** Typical Color Rendering Index and TM-30 Values at  $T_c=85^\circ\text{C}$

Nominal CCT <sup>1</sup>	R <sub>r</sub>	R <sub>g</sub>	R <sub>a</sub>	R <sub>1</sub>	R <sub>2</sub>	R <sub>3</sub>	R <sub>4</sub>	R <sub>5</sub>	R <sub>6</sub>	R <sub>7</sub>	R <sub>8</sub>	R <sub>9</sub>	R <sub>10</sub>	R <sub>11</sub>	R <sub>12</sub>	R <sub>13</sub>	R <sub>14</sub>	R <sub>15</sub>
2700K	96	99	98	96	98	97	94	96	95	98	98	97	95	91	92	96	97	97
5000K	96	99	98	98	98	98	95	98	96	97	97	95	96	97	91	97	98	96
6500K	96	99	98	98	98	99	97	98	98	99	98	95	96	98	93	98	99	96

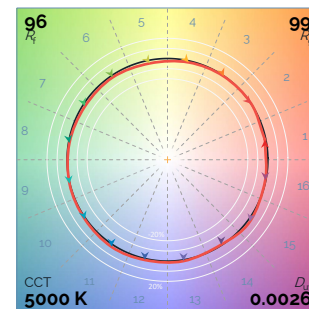
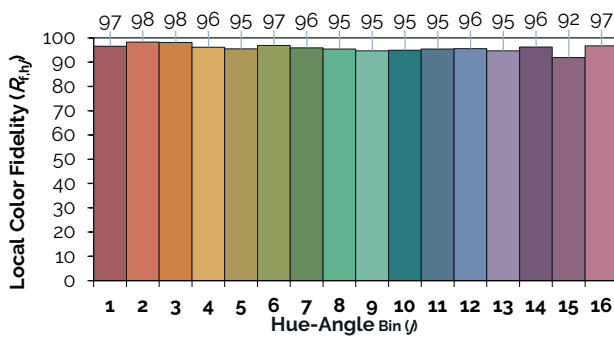
Note for Table 2:

1. Applicable for part numbers BXRV-TR-xxxxS-20A0-A-23-S2 with the Thrive spectrum
2. Bridgelux maintains a tolerance of  $\pm 3$  on Color Rendering Index R1-R15 measurements and TM-30 measurements.

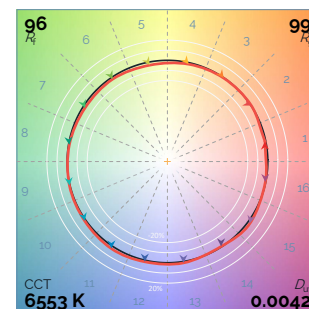
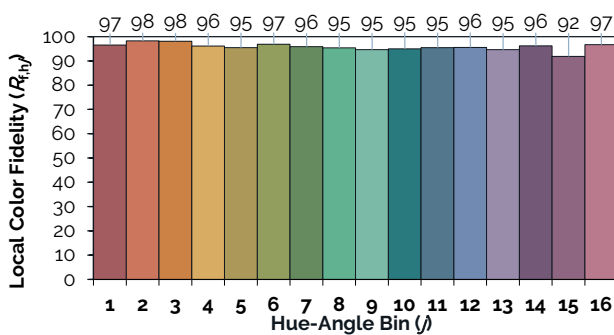
**Figure 1: 2700K Thrive TM-30 Graphs**



**Figure 2: 5000K Thrive TM-30 Graphs**



**Figure 3: 6500K Thrive TM-30 Graphs**



# Average Spectral Difference

## Spectral Matching to Natural Light

The lighting market is in the early stages of adoption of human-centric lighting (HCL). HCL encompasses the effects of lighting on the physical and emotional health and well-being of people. Throughout evolution, the human visual system has evolved under the natural light of sun and fire. These light sources have standardized industry spectral power definitions that describe the state of natural light. However, conventional metrics such as CCT, CRI, and TM-30 fail to adequately quantify the naturalness, or closeness of these light sources to the standardized natural spectra. Due to a lack of an industry standard metric to quantitatively measure the naturalness of a light source, Bridgelux has pioneered a new metric that takes the guesswork out of comparing LED light sources to natural light.

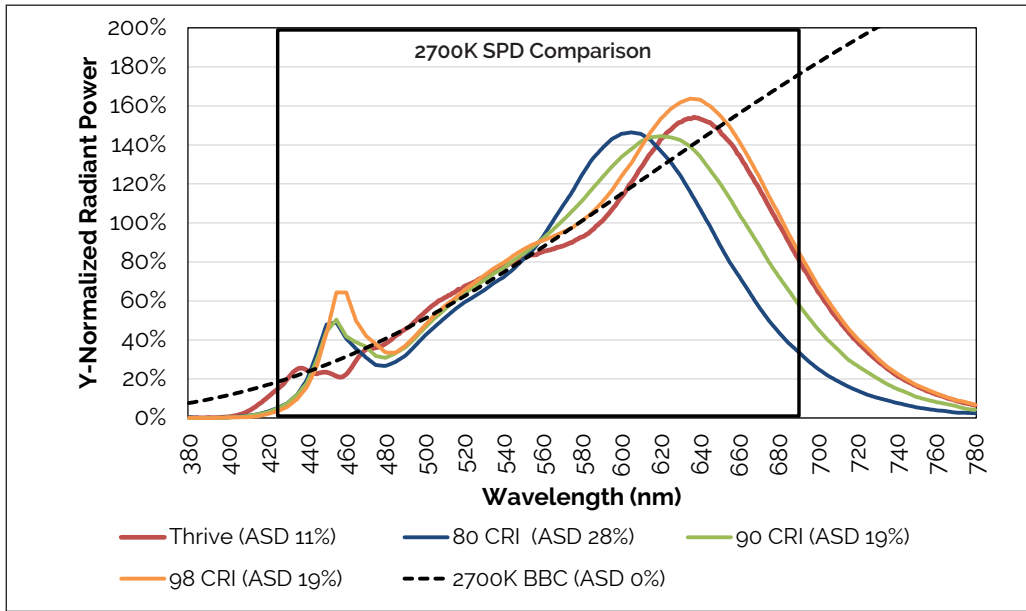
Average Spectral Difference, or ASD, is calculated by measuring the absolute difference between two spectra at discrete wavelengths. These values are averaged across a wavelength range derived from the photopic response curve, or  $V(\lambda)$ ; a luminous efficiency function describing the average spectral sensitivity of human perception of brightness. The range of 425nm to 690nm was selected to remove the tails of the  $V(\lambda)$  gaussian distribution below 1% of the peak value at 555nm, covering 99.9% of the area under the photopic response curve. Natural light is defined following the approach of IES TM-30; black body curves for light sources of  $\leq 4000K$  and the CIE standard illuminant D for light sources of  $\geq 5000K$ .

Natural light has an ASD of 0%; lower ASD values indicate a closer match to natural light. Thrive is engineered to provide the closest match to natural light available using proprietary chip, phosphor and packaging technology, resulting in an ASD between 8% to 11% for all CCTs used in Vesta products. By comparison, standard 80, 90, and 98 CRI light sources have ASD values that are 100% to 300% larger than Thrive. To learn more about the ASD metric, please review the Bridgelux whitepaper: Average Spectral Difference, a new method to make objective comparisons of naturalness between light sources; or contact your Bridgelux sales representative.

**Table 3:** Typical ASD Values at  $T_c=85^\circ C$

Nominal CCT	ASD
2700K	11%
5000K	9%
6500K	8%

**Figure 4: SPD Comparison**



# Electrical Characteristics

**Table 4:** Electrical Characteristics

Part Number	Nominal CCT $T_c = 85^\circ\text{C}$ (K)	Nominal Drive Current (mA)	Forward Voltage Pulsed, $T_c = 25^\circ\text{C}$ <sup>1, 2, 3, 7</sup>			Typical Temperature Coefficient of Forward Voltage <sup>4</sup> $\Delta V_f / \Delta T_c$ (mV/°C)	Typical Thermal Resistance Junction to Case <sup>5</sup> (°C/W)	Driver Selection Voltages <sup>6</sup>	
			Minimum (V)	Typical (V)	Maximum (V)			$V_f$ Min. Hot $T_c = 105^\circ\text{C}$ (V)	$V_f$ Max. Cold $T_c = -40^\circ\text{C}$ (V)
BXRV-TR-xxxxX-20A0-A- 23-S2	1800, 2700	500	33.1	35.2	37.4	-12.1	0.53	32.1	38.3
	3000, 4000, 5000, 6500K	500	34.1	36.3	38.5	-12.5		33.2	39.5

Notes for Table 4:

- Parts are tested in pulsed conditions,  $T_c = 25^\circ\text{C}$ . Pulse width is 10ms.
- Voltage minimum and maximum are provided for reference only and are not a guarantee of performance.
- Bridgelux maintains a tester tolerance of  $\pm 0.10\text{V}$  on forward voltage measurements.
- Typical temperature coefficient of forward voltage tolerance is  $\pm 0.1\text{mV}$  for nominal current.
- Thermal resistance value was calculated using total electrical input power; optical power was not subtracted from input power. The thermal interface material used during testing is not included in the thermal resistance value.
- $V_f$  min hot and max cold values are provided as reference only and are not guaranteed by test. These values are provided to aid in driver design and selection over the operating range of the product.
- This product has been designed and manufactured per IEC 62031:2018. This product has passed dielectric withstand voltage testing at 500 V. The working voltage designated for the insulation is 60V DC. The maximum allowable voltage across the array must be determined in the end product application.

# Absolute Maximum Ratings

**Table 5:** Maximum Ratings

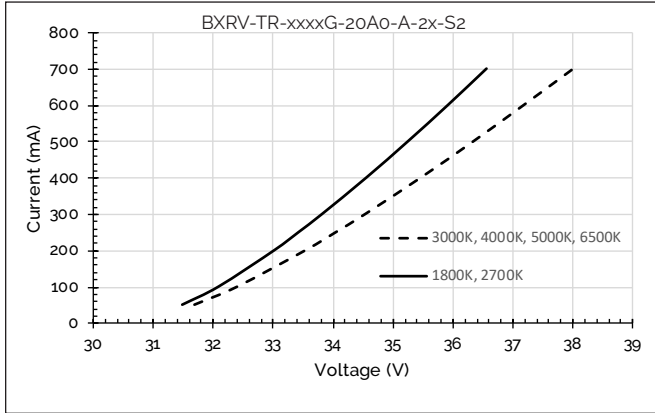
Parameter	Maximum Rating	
LED Junction Temperature ( $T_j$ )	125°C	
Storage Temperature	-40°C to +105°C	
Operating Case Temperature <sup>1</sup> ( $T_c$ )	105°C	
Maximum Total Drive Current <sup>4</sup>	700mA	
	Channel 1 2700K, 1800K	Channel 2 5000K/6500K 3000K/4000K
Maximum Drive Current Per Channel <sup>3,4</sup>	700mA	700mA
Maximum Peak Pulsed Drive Current <sup>5</sup>	960mA	720mA
Maximum Total Power	26.6W	

Notes for Table 5:

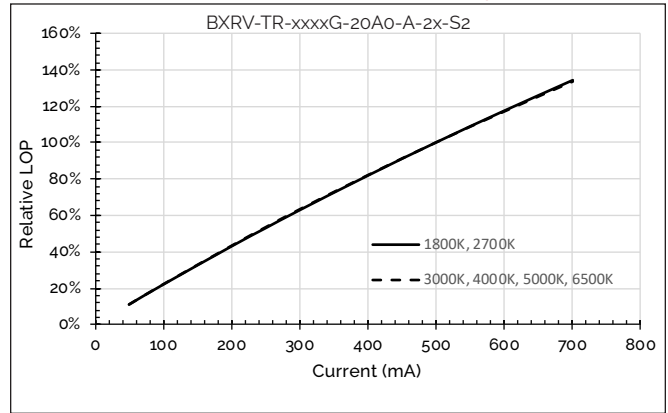
1. For IEC 62717 requirement, please contact Bridgelux Sales Support.
2. See Bridgelux Application Note AN101 for more information.
3. Lumen maintenance and lifetime predictions are valid for drive current and case temperature conditions used for LM-80 testing as included in the applicable LM-80 test report. Contact your Bridgelux sales representatives for the LM-80 report.
4. Maximum Drive Current is maximum combined drive currents between both 2700K and 6500K channels. For example, if 700mA is applied to one channel, no current may be applied to the other channel of the array. If 300mA is applied to one channel, then a maximum of 400mA can be applied to the other channel.
5. Bridgelux recommends a maximum duty cycle of 10% and pulse width of 20ms when operating LED arrays at the maximum peak pulsed current specified. Maximum peak pulsed currents indicate values where the LED array can be driven without catastrophic failures.

# Performance Curves

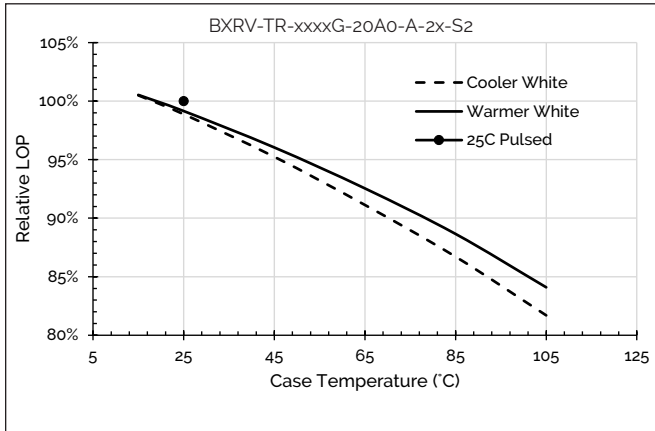
**Figure 5: Forward Voltage vs. Forward Current,  $T_c=25^\circ\text{C}$**



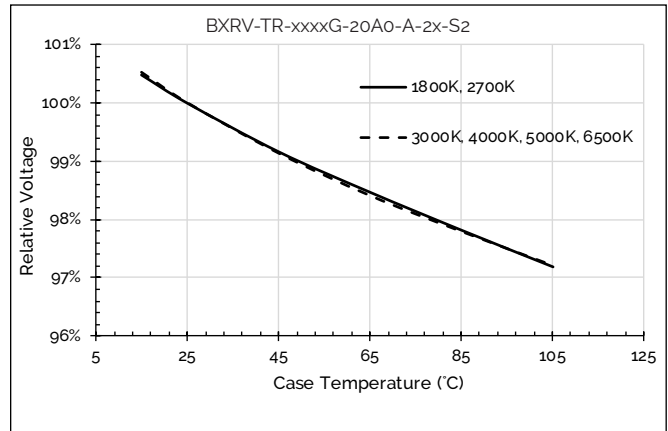
**Figure 6: Relative Flux vs. Drive Current,  $T_c=25^\circ\text{C}$**



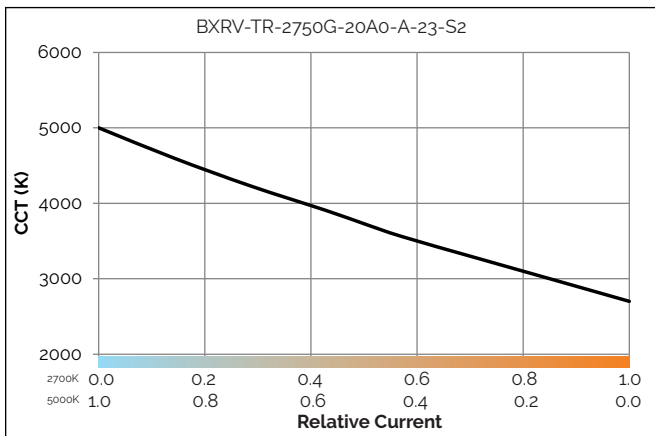
**Figure 7: Relative Flux vs. Case Temperature**



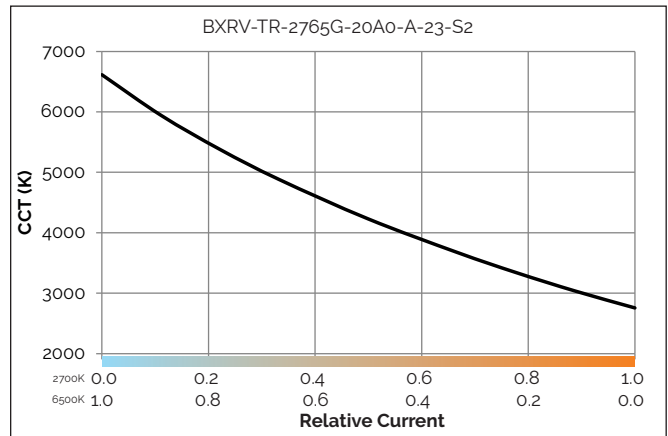
**Figure 8: Relative Voltage vs. Case Temperature**



**Figure 9: CCT vs. Relative Current**



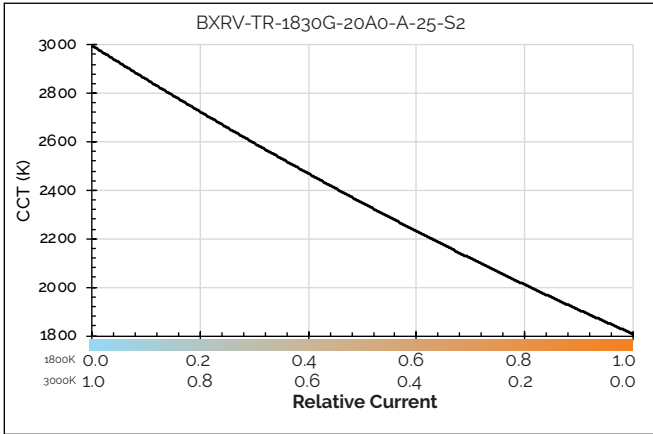
**Figure 10: CCT vs. Relative Current**



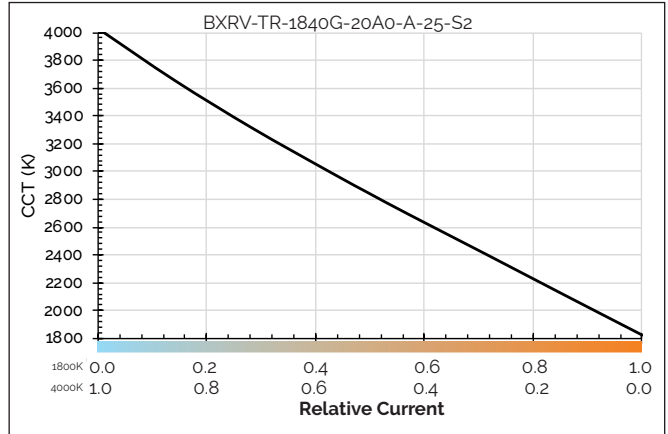


# Performance Curves

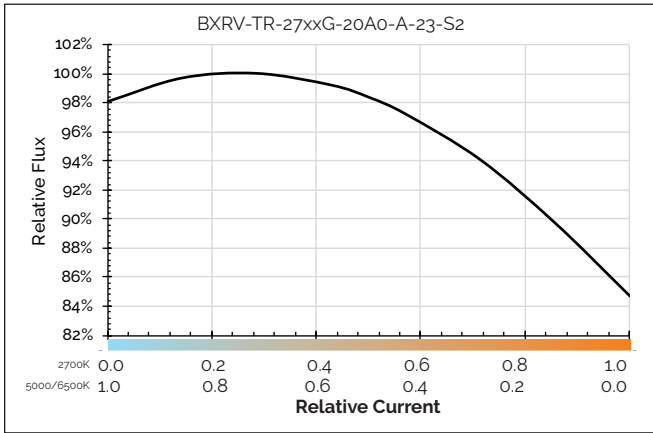
**Figure 11: CCT vs. Relative Current**



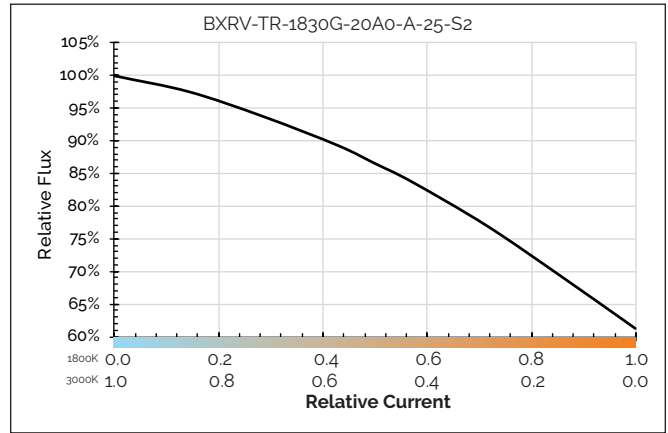
**Figure 12: CCT vs. Relative Current**



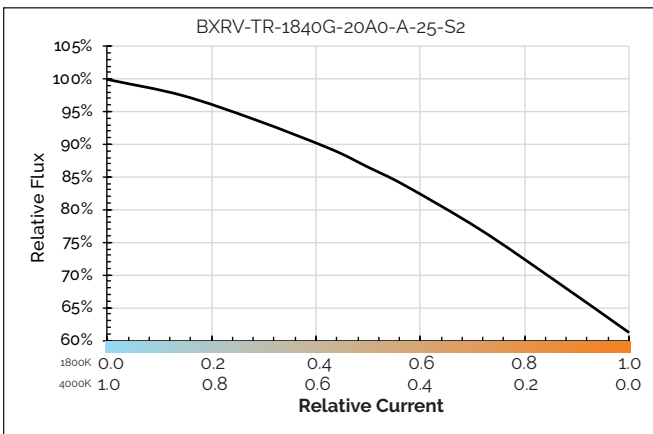
**Figure 13: Relative Flux vs. Relative Current**



**Figure 14: Relative Flux vs. Relative Current**

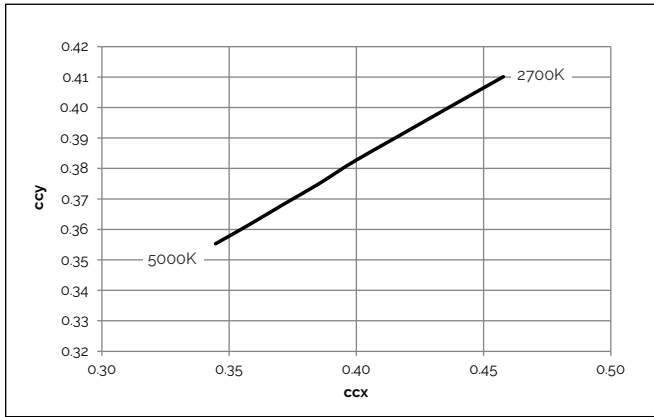


**Figure 15: Relative Flux vs. Relative Current**

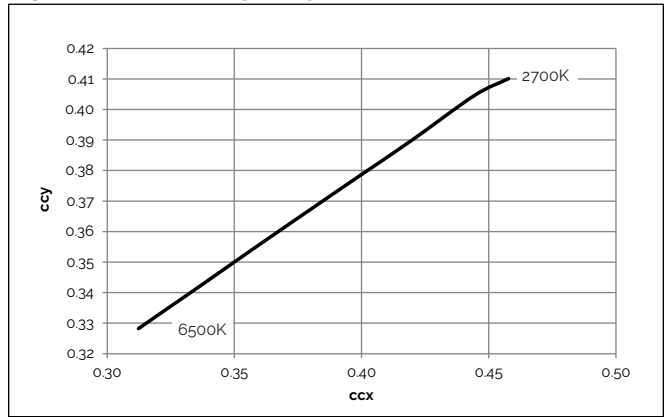


# Performance Curves

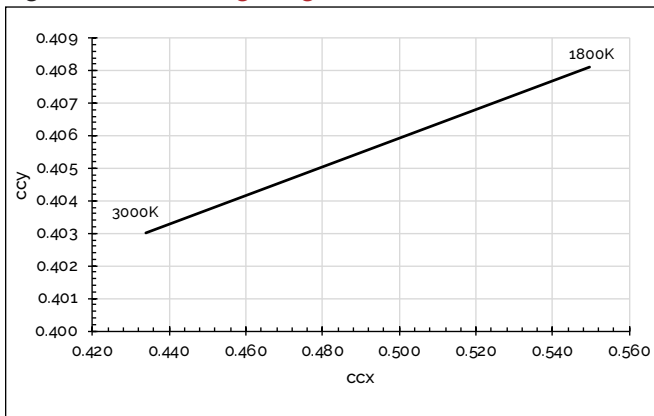
**Figure 16: CCT Tuning Range, Tc=85C**



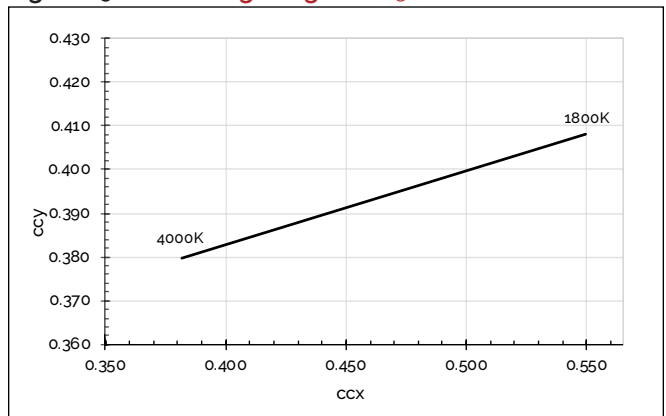
**Figure 17: CCT Tuning Range, Tc=85C**



**Figure 18: CCT Tuning Range, Tc=85C**

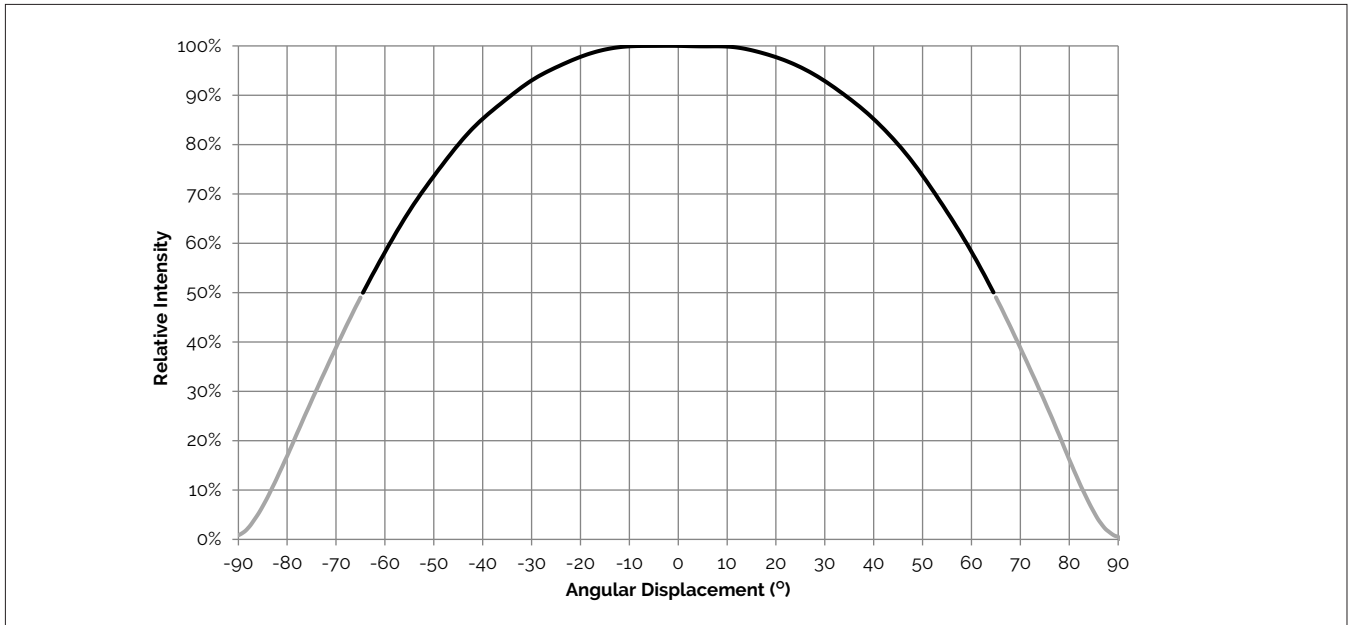


**Figure 19: CCT Tuning Range, Tc=85C**



# Typical Radiation Pattern

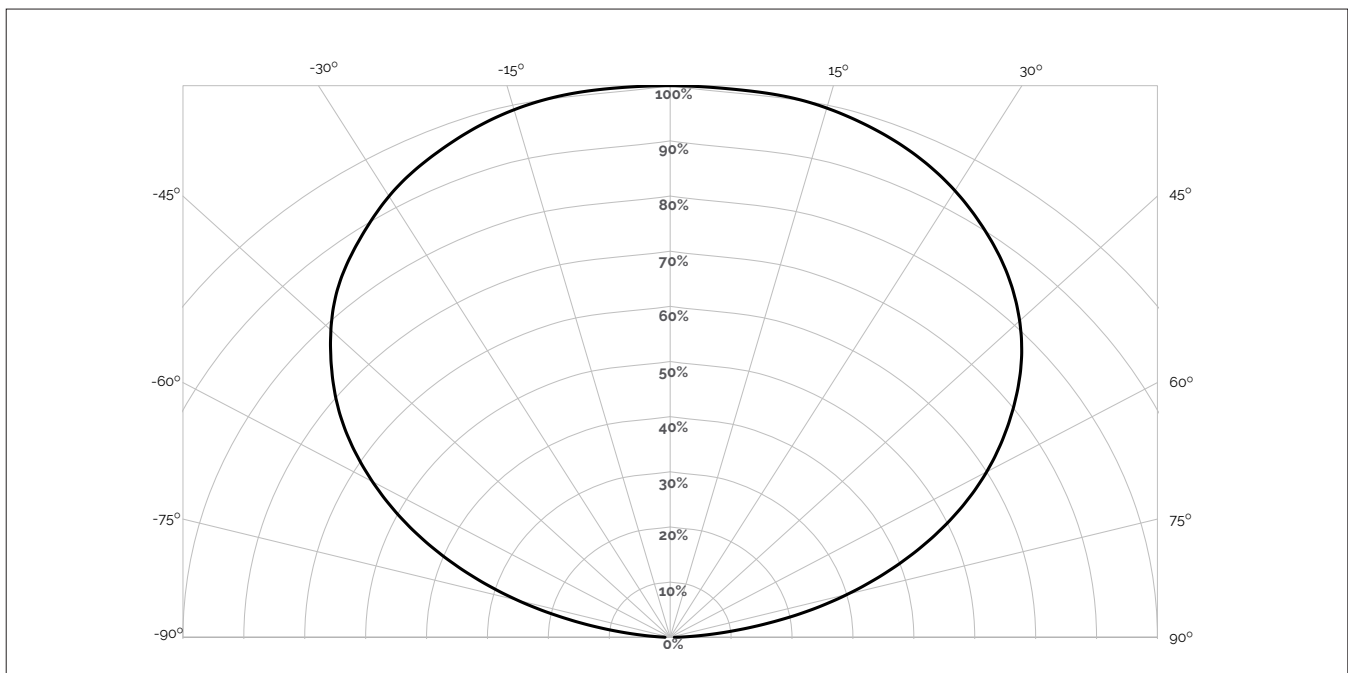
**Figure 20: Typical Spatial Radiation Pattern**



Notes for Figure 20:

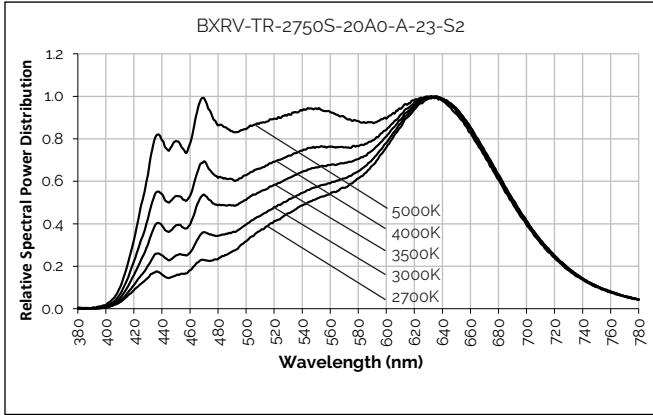
1. Typical viewing angle is 130°.
2. The viewing angle is defined as the off axis angle from the centerline where  $I_v$  is  $\frac{1}{2}$  of the peak value.

**Figure 21: Typical Polar Radiation Pattern**



# Typical Color Spectrum

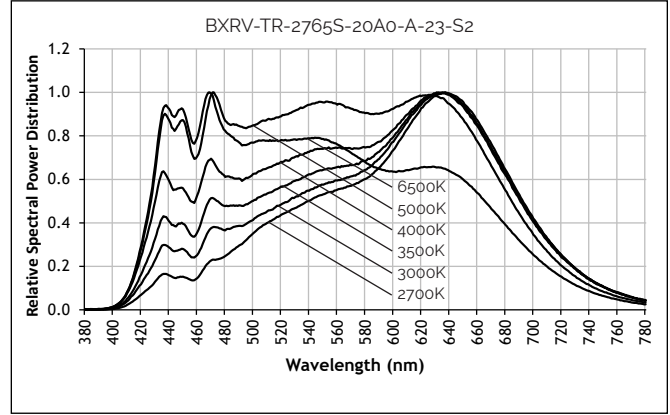
**Figure 22: 2700K - 5000K with Thrive**



Note for Figure 22:

1. Color spectra measured at nominal current and  $T_c = 85^\circ\text{C}$ .

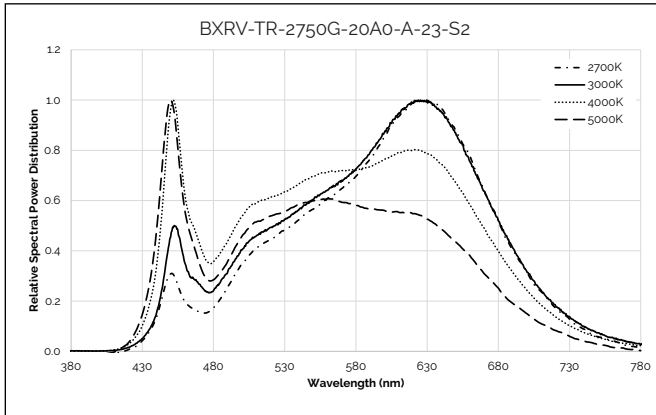
**Figure 23: 2700K - 6500K with Thrive**



Note for Figure 23:

1. Color spectra measured at nominal current and  $T_c = 85^\circ\text{C}$ .

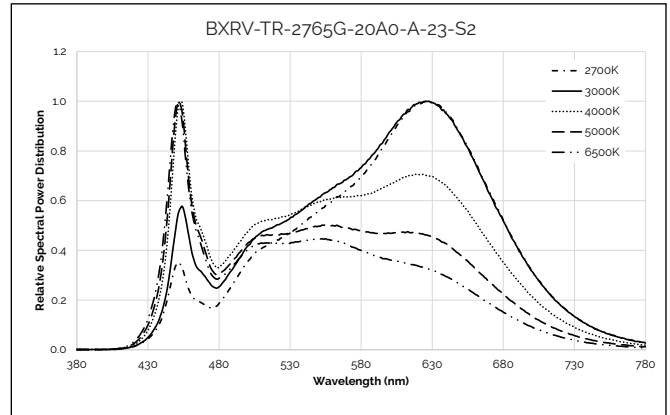
**Figure 24: 2700K - 5000K with 90 CRI**



Note for Figure 24:

1. Color spectra measured at nominal current and  $T_c = 25^\circ\text{C}$ .

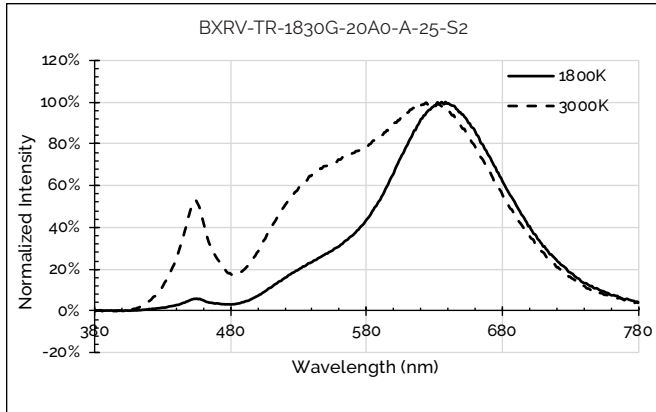
**Figure 25: 2700K - 6500K with 90 CRI**



Note for Figure 25:

1. Color spectra measured at nominal current and  $T_c = 25^\circ\text{C}$ .

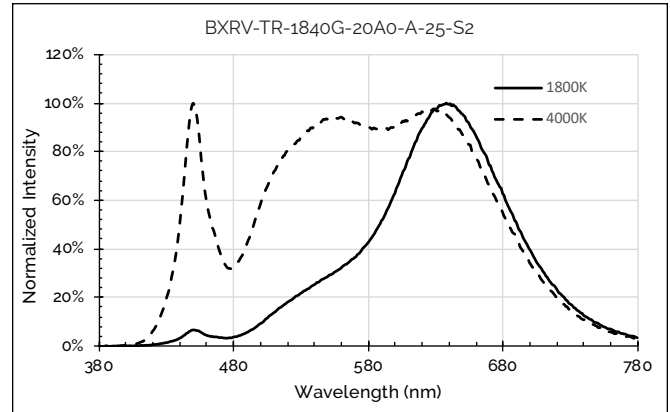
**Figure 26: 1800K - 3000K with 90 CRI**



Note for Figure 26:

1. Color spectra measured at nominal current and  $T_c = 25^\circ\text{C}$ .

**Figure 27: 1800K - 4000K with 90 CRI**

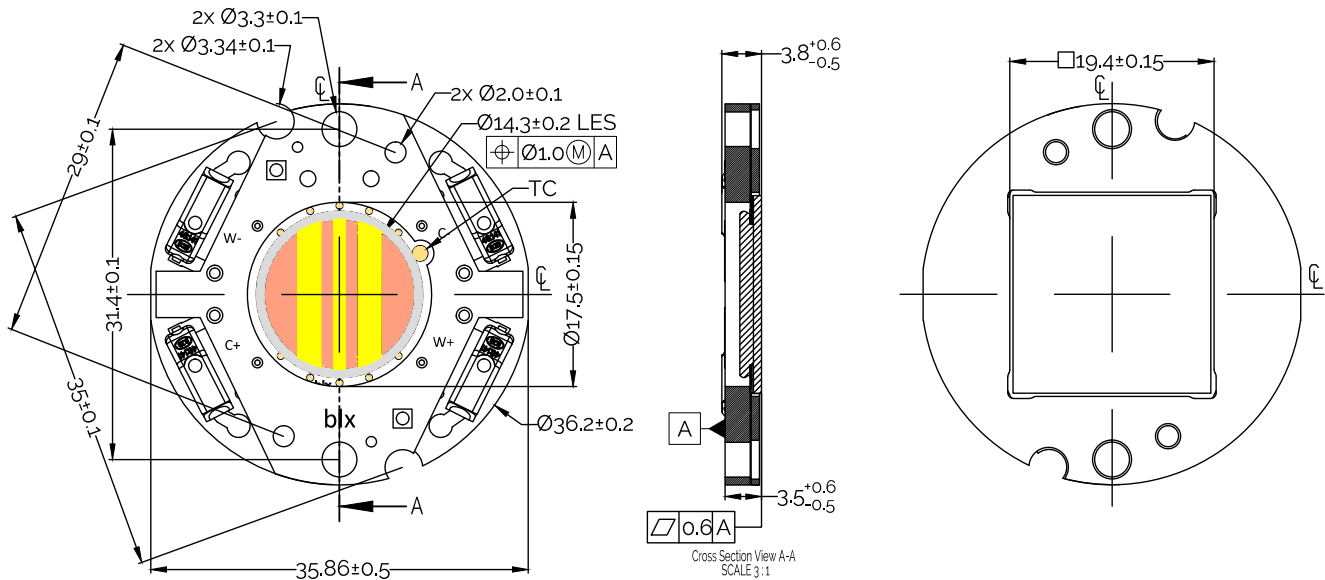


Note for Figure 27:

1. Color spectra measured at nominal current and  $T_c = 25^\circ\text{C}$ .

# Mechanical Dimensions

**Figure 28: Mechanical Drawing Specifications**



Notes for Figure 28:

1. Connectors are labeled "+" to denote positive polarity and "-" to denote negative polarity of the warmer white and cooler white channels.
2. Poke-In connectors accept solid and stranded wires with AWG wire sizes 20 - 24.
3. Recommended wire strip length is 7.0mm +/- 0.5mm.
4. Wires may be released by pushing into the wire release hole on the poke in connector. Bridgelux recommends the use of BJB tool 46.141.U801.8g.
5. Mounting holes (2X) are for M3 screws.
6. Bridgelux recommends two tapped holes for mounting screws with 31.4 ± 0.10mm center-to-center spacing.
7. Screws with flat shoulders (pan, dome, button, round, truss, mushroom) provide optimal torque control. Do not use flat, countersink, or raised head screws.
8. The maximum mounting screw torque value is 0.3 N-m (2.7 lbf-in).
9. Drawings are not to scale.
10. Drawing dimensions are in millimeters.
11. Unless otherwise specified, tolerances are ± 0.10mm.

# Color Binning Information

Figure 29: Graph of Bins in xy Color Space, Tc=85C

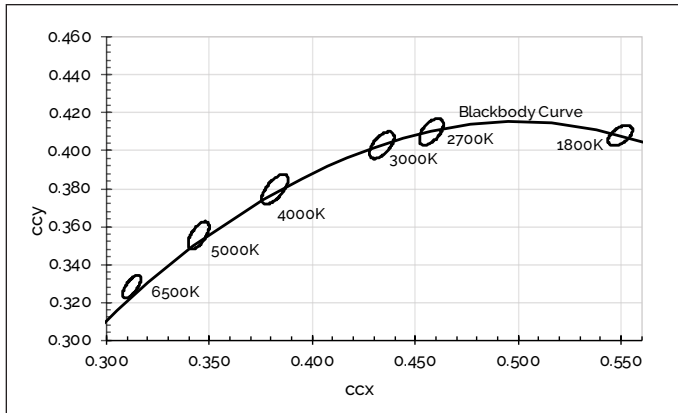


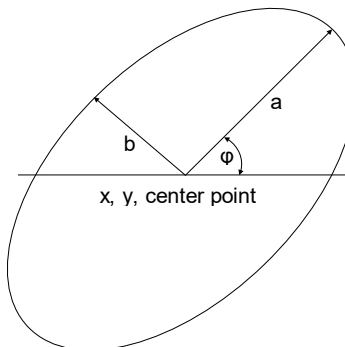
Table 6: McAdam ellipse CCT color bin definitions for product operating at  $T_c = 85^\circ\text{C}$

CCT	Center Point	Bin Size	Axis a	Axis b	Rotation Angle
2700K	x=0.4578 y= 0.4101	3 SDCM	0.00810	0.00420	53.70°
5000K	x=0.3447 y=0.3553	3 SDCM	0.00822	0.00354	59.62°
6500K	x=0.3123 y=0.3282	3 SDCM	0.00690	0.00285	58.57°
1800K	x=0.5496 y=0.4081	5SDCM	0.01164	0.00655	40.00°
3000K	x=0.4338 y=0.4030	3SDCM	0.00834	0.00408	53.22°
4000K	x=0.3818 y=0.3797	3SDCM	0.00939	0.00402	53.72°

Notes for Table 6:

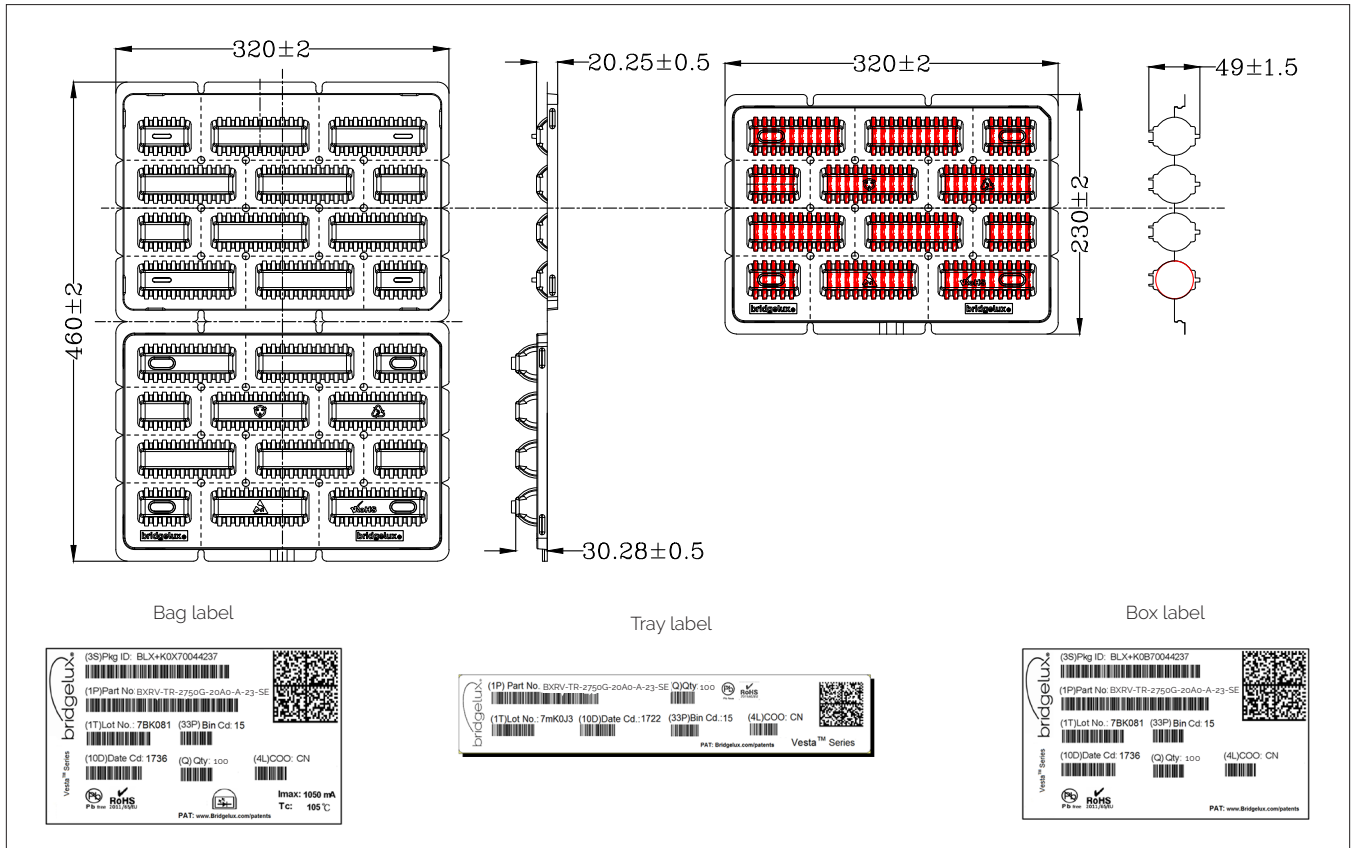
1. The x,y center points are the center points of the respective ANSI bins in the CIE 1931 xy Color Space
2. Products are binned at Tc=85°C
3. Bridgelux maintains a tolerance of +/-0.007 on x and y color coordinates in the CIE 1931 Color Space

Figure 30: Definition of the McAdam ellipse



# Packaging and Labeling

**Figure 31: Packaging Specifications**



Notes for Figure 31:

1. Each plastic tray holds 100 arrays.
2. Each tray is sealed in an anti-static bag. One such bag is placed in a small box and shipped. Depending on quantities ordered, a bigger shipping box, containing multiple small boxes may be used to ship products.
3. Each bag and small box is labeled as shown above.
4. The dimensions of the small shipping box are 350 x 245 x 67 mm.

**Figure 32: Product Labeling**

Bridgelux arrays have laser markings on the back side of the substrate to help with product identification. In addition to the product identification markings, Bridgelux arrays also contain markings for internal Bridgelux manufacturing use only. The image below shows which markings are for customer use and which ones are for Bridgelux internal use only. The Bridgelux internal manufacturing markings are subject to change without notice, however these will not impact the form, function or performance of the array.



# Design Resources

## Application Notes

Vesta SE Series Tunable White arrays are intended for use in dry, indoor applications. Bridgelux has developed a comprehensive set of application notes and design resources to assist customers in successfully designing with the Vesta SE Series product family of LED array products. For a list of resources under development, visit [www.bridgelux.com](http://www.bridgelux.com).

## Optical Source Models

Optical source models and ray set files are available for all Bridgelux products. For a list of available formats, visit [www.bridgelux.com](http://www.bridgelux.com).

## 3D CAD Models

Three dimensional CAD models depicting the product outline of all Bridgelux Vesta SE Series LED arrays are available in both IGS and STEP formats. Please contact your Bridgelux sales representative for assistance.

## LM80

Please contact your Bridgelux sales representative for more information.

# Precautions

## CAUTION: CHEMICAL EXPOSURE HAZARD

Exposure to some chemicals commonly used in luminaire manufacturing and assembly can cause damage to the LED array. Please consult Bridgelux Application Note for additional information.

## CAUTION: EYE SAFETY

Eye safety classification for the use of Bridgelux Vesta Series is in accordance with IEC/TR62778 specification 'IEC 62471 for the assessment of blue light hazard to light source and luminaires'. Vesta Series Tunable White arrays are classified as Risk Group 1 when operated at or below the maximum drive current. Please use appropriate precautions. It is important that employees working with LEDs are trained to use them safely.

## CAUTION: RISK OF BURN

Do not touch the Vesta Series LED array during operation. Allow the array to cool for a sufficient period of time before handling. The Vesta Series LED array may reach elevated temperatures such that could burn skin when touched.

## CAUTION

### CONTACT WITH LIGHT EMITTING SURFACE (LES)

Avoid any contact with the LES. Do not touch the LES of the LED array or apply stress to the LES (yellow phosphor resin area). Contact may cause damage to the LED array.

Optics and reflectors must not be mounted in contact with the LES (yellow phosphor resin area). Optical devices may be mounted on the top surface of the Vesta Series LED array. Use the mechanical features of the LED array housing, edges and/or mounting holes to locate and secure optical devices as needed.

# Disclaimers

## STANDARD TEST CONDITIONS

Unless otherwise stated, array testing is performed at the nominal drive current.

## MINOR PRODUCT CHANGE POLICY

The rigorous qualification testing on products offered by Bridgelux provides performance assurance. Slight cosmetic changes that do not affect form, fit, or function may occur as Bridgelux continues product optimization.



# About Bridgelux: Bridging Light and Life™

At Bridgelux, we help companies, industries and people experience the power and possibility of light. Since 2002, we've designed LED solutions that are high performing, energy efficient, cost effective and easy to integrate. Our focus is on light's impact on human behavior, delivering products that create better environments, experiences and returns—both experiential and financial. And our patented technology drives new platforms for commercial and industrial luminaires.

**For more information about the company, please visit**

**[bridgelux.com](http://bridgelux.com)**

**[twitter.com/Bridgelux](https://twitter.com/Bridgelux)**

**[facebook.com/Bridgelux](https://facebook.com/Bridgelux)**

**[youtube.com/user/Bridgelux](https://youtube.com/user/Bridgelux)**

**[linkedin.com/company/bridgelux](https://linkedin.com/company/bridgelux)**

**WeChat ID: BridgeluxInChina**



46430 Fremont Blvd  
Fremont, CA 94538 USA  
Tel (925) 583-8400  
**[www.bridgelux.com](http://www.bridgelux.com)**

© 2021 Bridgelux, Inc. All rights reserved 2021. Product specifications are subject to change without notice. Bridgelux, the Bridgelux stylized logo design and Vesta are registered trademarks of Bridgelux, Inc. All other trademarks are the property of their respective owners.

**Bridgelux Vesta SE Series Tunable White Gen 2 13mm Integrated Array with S2 Holder Product Data Sheet DS362 Rev. A (03/2021)**